



Typical Applications

The HMC320MS8G / HMC320MS8GE is ideal for:

- UNII
- HiperLAN

Features

- Selectable Functionality:
 LNA, Driver, or LO Buffer Amp
- Adjustable Input IP3 Up to +10 dBm
- +3V Operation
- Ultra Small 8 Lead MSOP: 14.8 x 14.8 x 1 mm

Functional Diagram

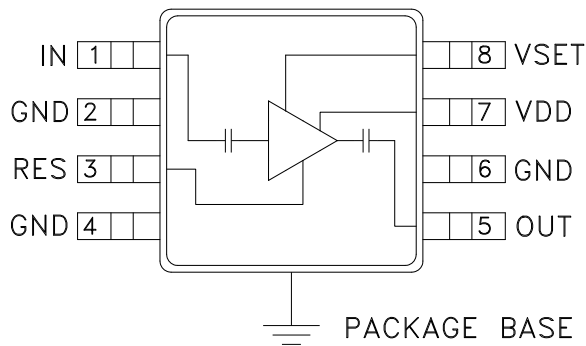

General Description

The HMC320MS8G & HMC320MS8GE are low cost C-band fixed gain Low Noise Amplifiers (LNA). The HMC320MS8G & HMC320MS8GE operate using a single positive supply that can be set between +3V and +5V. With +3V bias, the LNA provides a noise figure of 2.5 dB, 1 dB gain and better than 10 dB return loss across the UNII band. The HMC320MS8G & HMC320MS8GE also feature an adaptive biasing that allows the user to select the optimal P1dB performance for their system using an external set resistor on the “RES” pin. P1dB performance can be set between a range of +1 dBm to +13 dBm. The low cost LNA uses an 8-leaded MSOP ground base surface mount plastic package, which occupies less than 14.8 mm².

Electrical Specifications, $T_A = +25^\circ C$, $V_{dd} = +3V$

| Parameter | Low Power* (VSET = 0V, I _{dd} = 7 mA) | | | Medium Power* (VSET = 3V, I _{dd} = 25 mA) | | | High Power* (VSET = 3V, I _{dd} = 40 mA) | | | Units |
|--|---|-------|-------|---|-------|-------|---|-------|-------|-------|
| | Min. | Typ. | Max. | Min. | Typ. | Max. | Min. | Typ. | Max. | |
| Frequency Range | 5 - 6 | | | 5 - 6 | | | 5 - 6 | | | GHz |
| Gain | 8 | 10 | 16 | 8 | 12 | 16 | 9 | 13 | 16 | dB |
| Gain Variation over Temperature | | 0.025 | 0.035 | | 0.025 | 0.035 | | 0.025 | 0.035 | dB/°C |
| Gain Flatness | | ±0.5 | | | ±1.0 | | | ±1.5 | | dB |
| Noise Figure | | 2.7 | 3.8 | | 2.5 | 3.8 | | 2.6 | 3.8 | dB |
| Input Return Loss | 4 | 10 | | 4 | 10 | | 4 | 10 | | dB |
| Output Return Loss | 7 | 13 | | 10 | 18 | | 10 | 20 | | dB |
| Output Power for 1 dB Compression (P1dB) | -4 | -1 | | 6 | 9 | | 9 | 12 | | dBm |
| Input Third Order Intercept Point (IIP3) | -3 | 1 | | 4 | 8 | | 6 | 10 | | dBm |
| Supply Current (I _{dd}) | | 7 | | | 25 | | | 40 | | mA |

* R_{BIAS} resistor value sets current. See adaptive biasing application note.



**Broadband Gain & Return Loss
 Medium Power Bias**

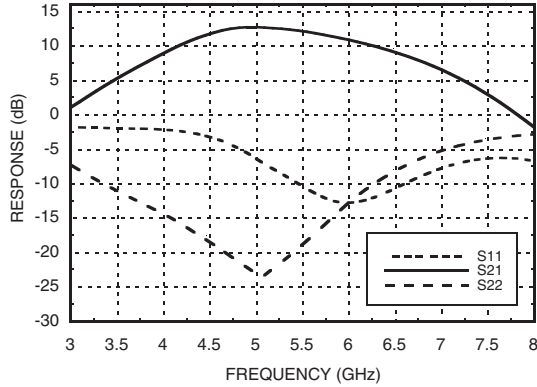

Gain @ Three Bias Conditions

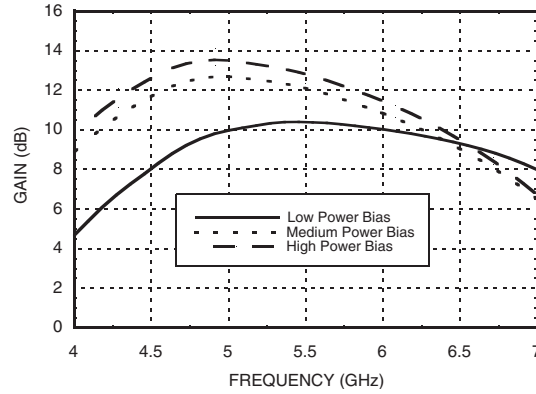

**Gain vs. Temperature
 Medium Power Bias**

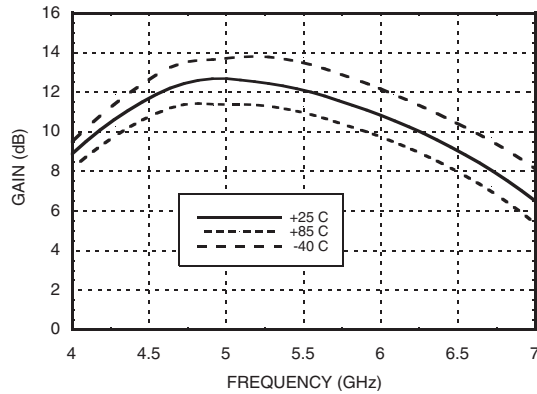

**Input Return Loss
 @ Three Bias Conditions**

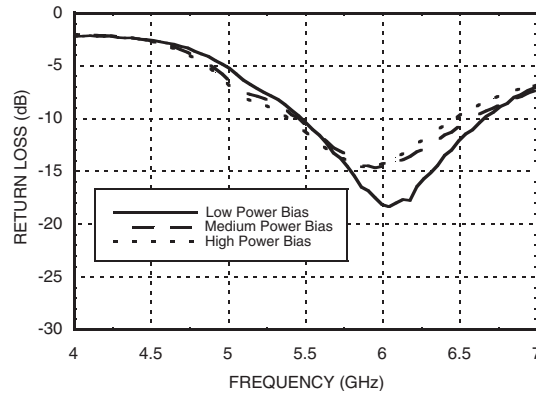

**Noise Figure vs. Temperature
 Medium Power Bias**

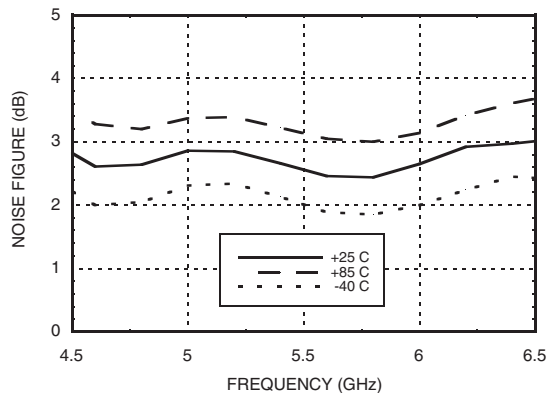

**Output Return Loss
 @ Three Bias Conditions**

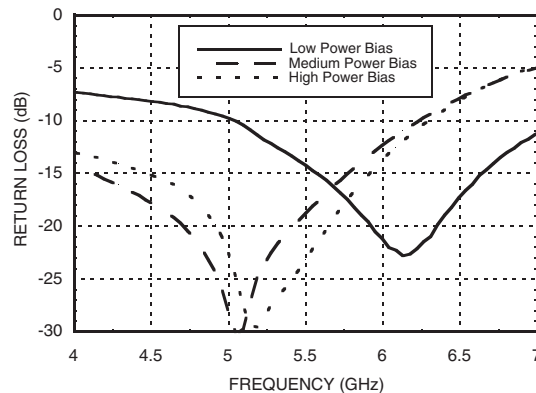



**Noise Figure
 @ Three Bias Conditions**

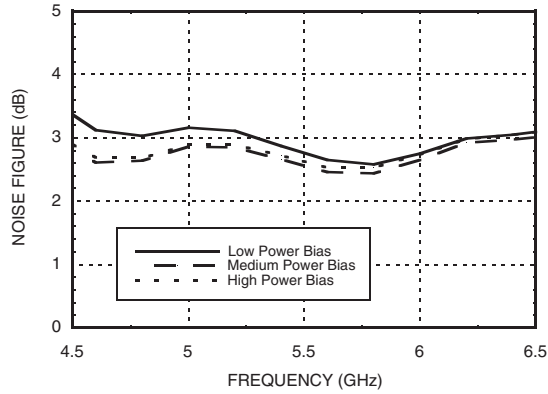

Input IP3 @ Three Bias Conditions

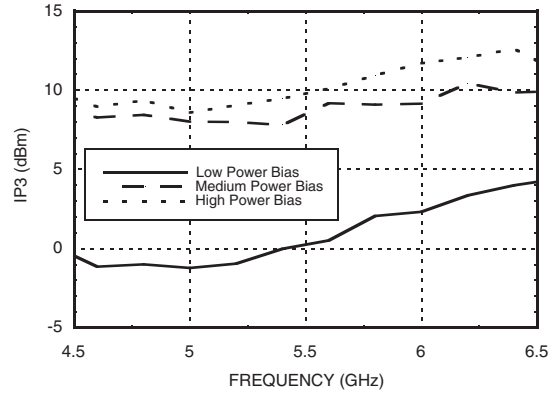

**Output 1dB Compression
 @ Three Bias Conditions**

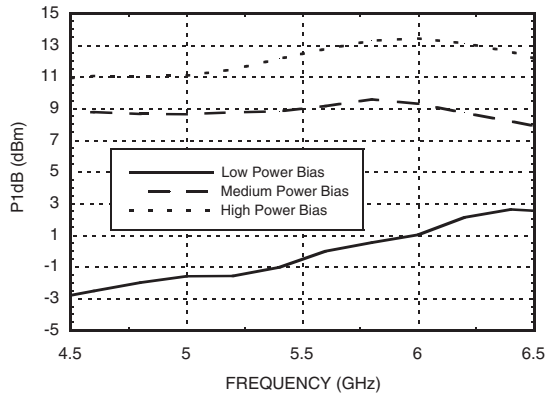

**Reverse Isolation
 @ Three Bias Conditions**

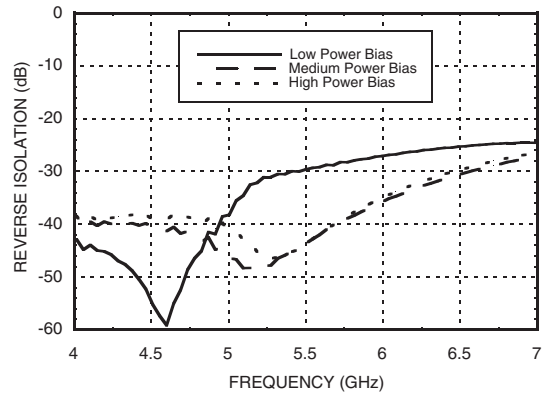



Adaptive Biasing

Optimizing P1dB Performance

The bias level may be changed to adjust the P1dB and return loss performance. The table below contains the HMC-320MS8G RF performance as a function of various VSET and RBIAS settings. It will be necessary for the VSET voltage source to provide 100uA of current to the amplifier. The Idd and Vdd quiescent performance will not change as a function of changing the VSET voltage.

RF Performance at 5.8 GHz (Vdd = +3V)

| VSET (VDC) | RBIAS Resistor Between Pin 3 and GND (Ohms) | Idd (mA) | Output P1dB (dBm) | Output Return Loss (dB) |
|------------|---|----------|-------------------|-------------------------|
| 0 | 174 | 7 | 1.0 | 16.0 |
| 3 | 22 | 25 | 9.0 | 12.0 |
| 3 | 7 | 40 | 13.0 | 15.0 |
| 3 | GND (No Resistor) | 60 | 14.0 | 15.0 |

Applying the adaptive biasing

A dynamically controlled bias can be implemented with this design. A typical application will include sensing an RF signal level and then adjusting the VSET. The bias adjustment can be accomplished by either analog or digital means, after the RF signal has been detected and translated to a DC voltage using external power detection circuitry.

Schematic

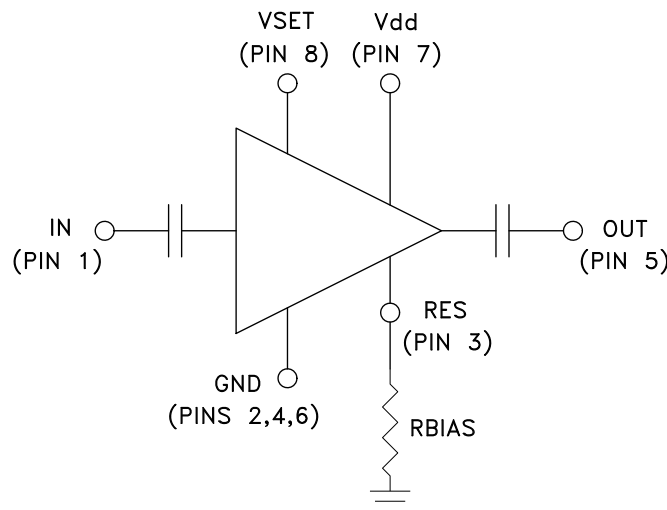



Absolute Maximum Ratings

| | |
|---|----------------|
| Drain Bias Voltage (Vdd) | +7.0 Vdc |
| Control Voltage Range (VSET) | 0 to Vdd |
| RF Input Power (RFIN)(Vdd = +3.0 Vdc) | +5 dBm |
| Channel Temperature | 150 °C |
| Continuous Pdiss (T = 85 °C) (derate 2.98 mW/°C above 85 °C) | 0.194 W |
| Thermal Resistance (channel to ground paddle) | 336 °C/W |
| Storage Temperature | -65 to +150 °C |
| Operating Temperature | -40 to +85 °C |
| ESD Sensitivity (HBM) | Class 1A |

Truth Table

| VSET | Operating Current Idd | Operating State | Resistor Rbias |
|------|-----------------------|-----------------|----------------|
| 0V | 7 mA | Low Power | 174 Ohm |
| 3V | 25 mA | Medium Power | 22 Ohm |
| 3V | 40 mA | High Power | 7 Ohm |

Set external bias resistor (RBIAS) to achieve desired operating current, 0 < RBIAS < 200 Ohm.



ELECTROSTATIC SENSITIVE DEVICE
OBSERVE HANDLING PRECAUTIONS

Outline Drawing

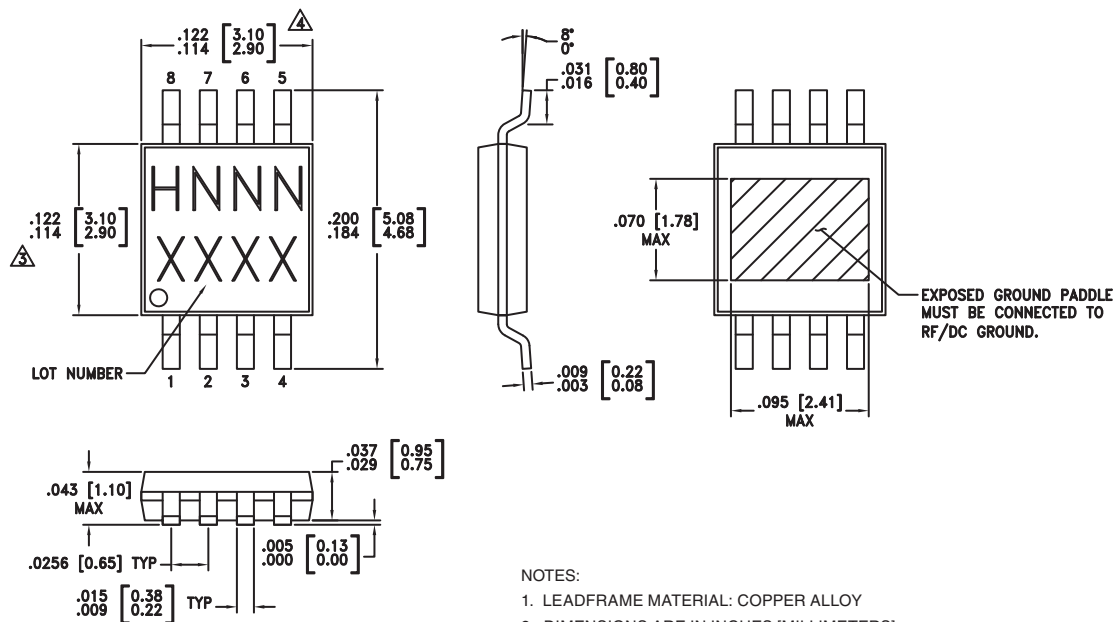

NOTES:

- LEADFRAME MATERIAL: COPPER ALLOY
- DIMENSIONS ARE IN INCHES (MILLIMETERS)
- DIMENSION DOES NOT INCLUDE MOLDFLASH OF 0.15mm PER SIDE.
- DIMENSION DOES NOT INCLUDE MOLDFLASH OF 0.25mm PER SIDE.
- ALL GROUND LEADS AND GROUND PADDLE MUST BE SOLDERED TO PCB RF GROUND.

Package Information

| Part Number | Package Body Material | Lead Finish | MSL Rating | Package Marking ^[3] |
|-------------|--|---------------|---------------------|--------------------------------|
| HMC320MS8G | Low Stress Injection Molded Plastic | Sn/Pb Solder | MSL1 ^[1] | H320 XXXX |
| HMC320MS8GE | RoHS-compliant Low Stress Injection Molded Plastic | 100% matte Sn | MSL1 ^[2] | H320 XXXX |

[1] Max peak reflow temperature of 235 °C

[2] Max peak reflow temperature of 260 °C

[3] 4-Digit lot number XXXX

For price, delivery, and to place orders, please contact Hittite Microwave Corporation:

SUNSTAR 微波光电 www.hittite.com / TEL:0755-83396822 FAX:0755-83376182 E-MAIL: szss20@163.com

Order On-line at www.hittite.com



Evaluation PCB

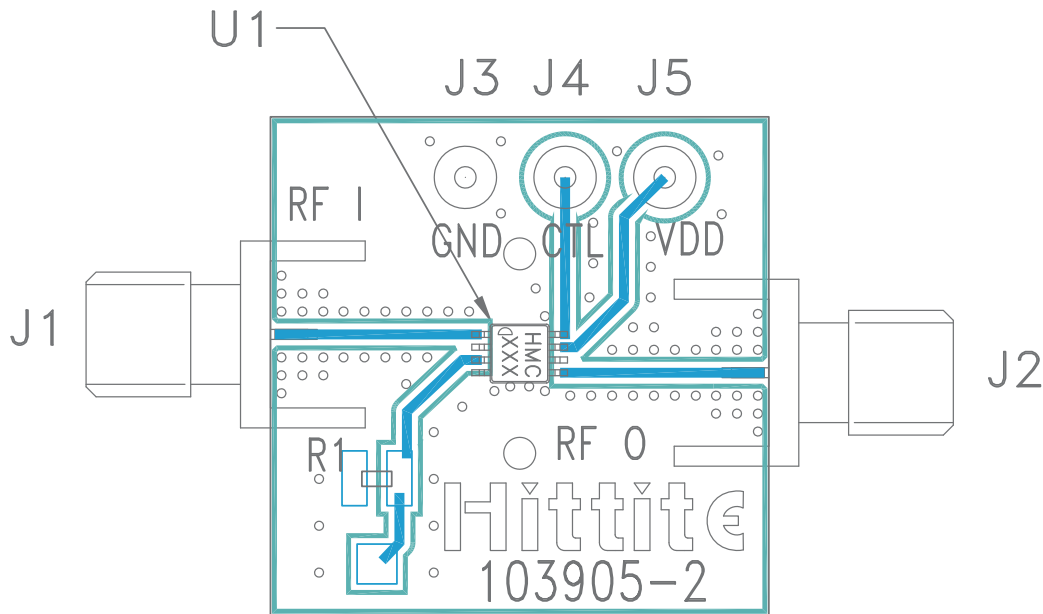

List of Materials for Evaluation PCB 103907 [1]

| Item | Description |
|------------|------------------------------------|
| J1, J2 | PCB Mount SMA Connector |
| J3, J4, J5 | DC Pins |
| R1 | 22 Ohm Resistor, 0603 Pkg. |
| U1 | HMC320MS8G / HMC320MS8GE Amplifier |
| PCB [2] | 103905 Evaluation PCB |

[1] Reference this number when ordering complete evaluation PCB
 [2] Circuit Board Material: Rogers 4350

The circuit board used in the final application should use RF circuit design techniques. Signal lines should have 50 ohm impedance while the package ground leads and exposed paddle should be connected directly to the ground plane similar to that shown. A sufficient number of via holes should be used to connect the top and bottom ground planes. The evaluation circuit board shown is available from Hittite upon request.