



HMC752LC4

GaAs HEMT MMIC LOW NOISE AMPLIFIER, 24 - 28 GHz

Typical Applications

This HMC752LC4 is ideal for:

- Point-to-Point Radios
- Point-to-Multi-Point Radios
- Military & Space
- Test Instrumentation

Features

- Noise Figure: 2.5 dB
- Gain: 25 dB
- P1dB Output Power: +13 dBm
- Supply Voltage: +3V @ 70 mA
- Output IP3: +26 dBm
- 50 Ohm matched Input/Output
- 24 Lead Ceramic 4x4mm SMT Package: 16mm²

Functional Diagram

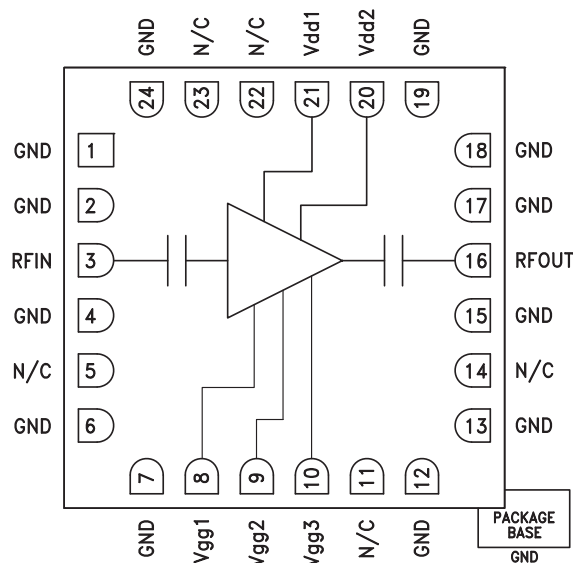

General Description

The HMC752LC4 is a GaAs MMIC Low Noise Wide-band Amplifier housed in a leadless 4x4 mm ceramic surface mount package. The amplifier operates between 24 and 28 GHz, providing up to 25 dB of small signal gain, 2.5 dB noise figure, and output IP3 of +26 dBm, while requiring only 70 mA from a +3V supply. The P1dB output power of up to +13 dBm enables the LNA to function as a LO driver for balanced, I/Q or image reject mixers. The HMC752LC4 also features I/Os that are DC blocked and internally matched to 50 Ohms, making it ideal for high capacity microwave radios or VSAT applications.

Electrical Specifications, $T_A = +25^\circ C$, $V_{dd} = V_{dd1} = V_{dd2} = +3V$, $I_{dd} = I_{dd1} + I_{dd2} = 70 mA$ ^[2]

Parameter	Min.	Typ.	Max.	Units
Frequency Range	24 - 28			GHz
Gain ^[1]	23	25		dB
Gain Variation over Temperature	0.02			dB / °C
Noise Figure ^[1]		2.5	3	dB
Input Return Loss	14			dB
Output Return Loss	14			dB
Output Power for 1 dB Compression ^[1]	13			dBm
Saturated Output Power (P _{sat}) ^[1]	16			dBm
Output Third Order Intercept (IP3)	26			dBm
Supply Current (I _{dd}) (V _{dd} = 3V, V _{gg} = V _{gg1} = V _{gg2} = V _{gg3} = -0.3V Typ.)	70			mA

[1] Board loss subtracted out for gain, power and noise figure measurement

[2] Adjust V_{gg} = between -1 to 0.3V to achieve I_{dd} = 70mA

For price, delivery, and to place orders, please contact Hittite Microwave Corporation:

SUNSTAR 微波光电 www.hittite.com / TEL:0755-83396822 FAX:0755-83376182 E-MAIL: szss20@163.com

Order On-line at www.hittite.com



HMC752LC4

GaAs HEMT MMIC LOW NOISE AMPLIFIER, 24 - 28 GHz

8

LOW NOISE AMPLIFIERS - SMT

Gain vs. Temperature

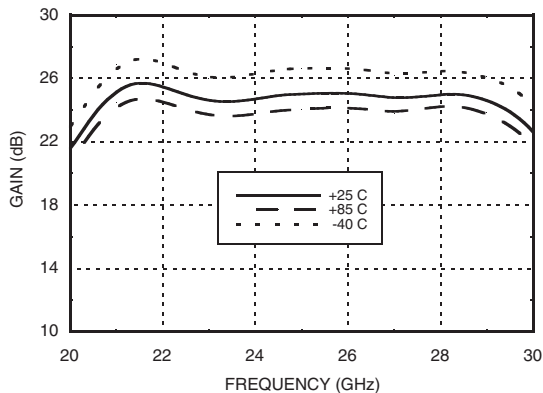

Gain vs. I_{dd}

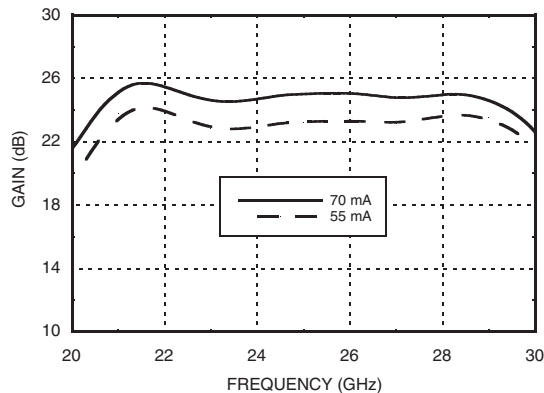

Input Return Loss vs. Temperature

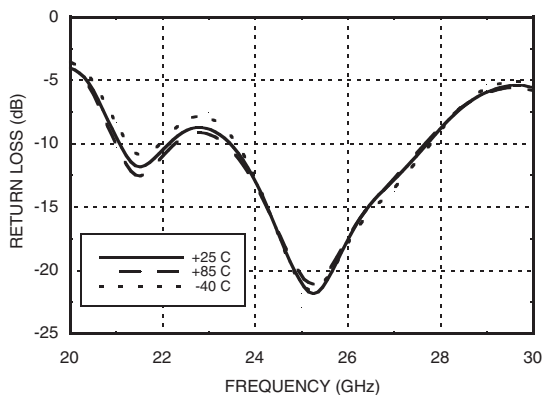

Output Return Loss vs. Temperature

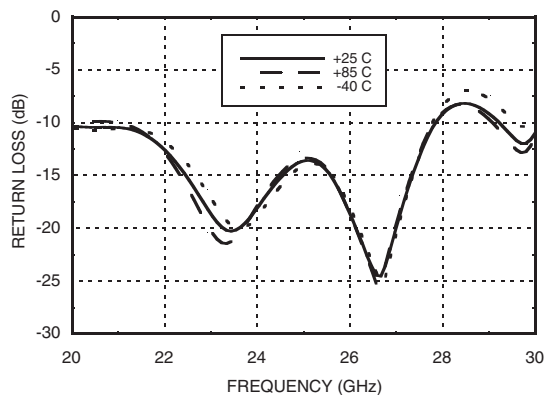

Noise Figure vs. Temperature

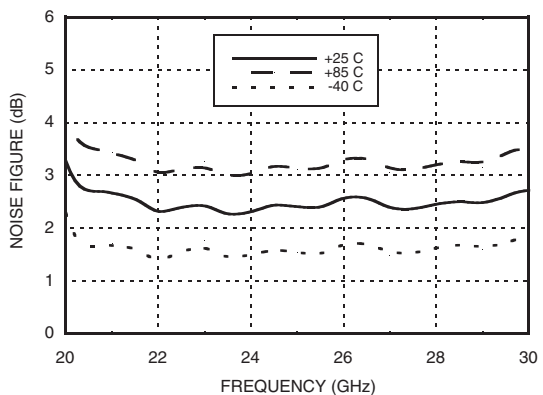

Noise Figure vs. I_{dd}

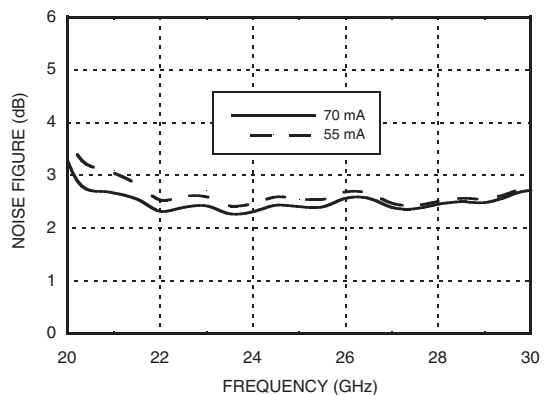



HMC752LC4

GaAs HEMT MMIC LOW NOISE AMPLIFIER, 24 - 28 GHz

8 LOW NOISE AMPLIFIERS - SMT

Output IP3 vs. Temperature

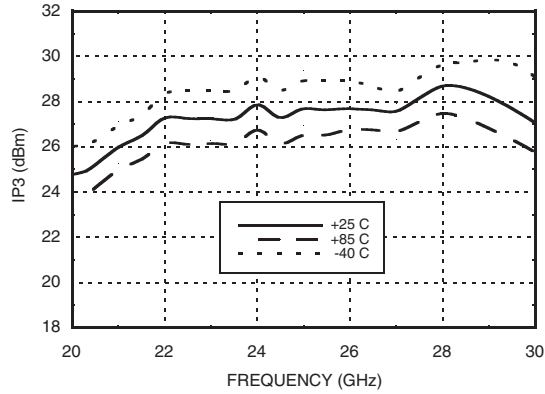

Output IP3 vs. Idd

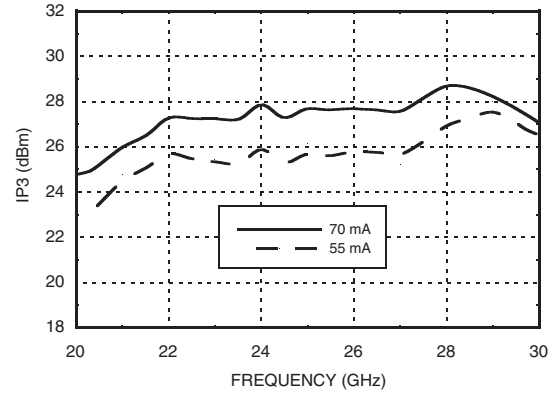

P1dB vs. Temperature

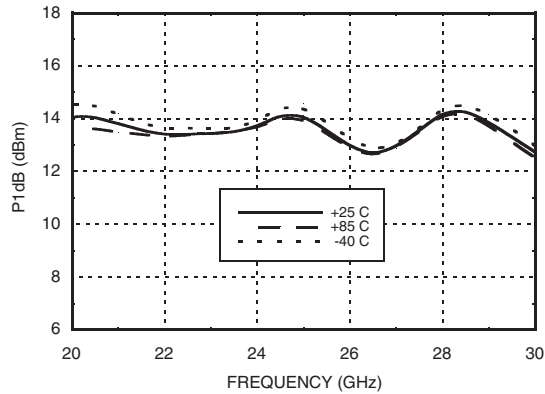

P1dB vs. Idd

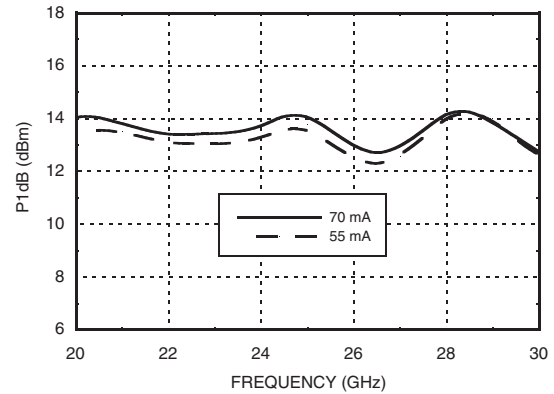

Psat vs. Temperature

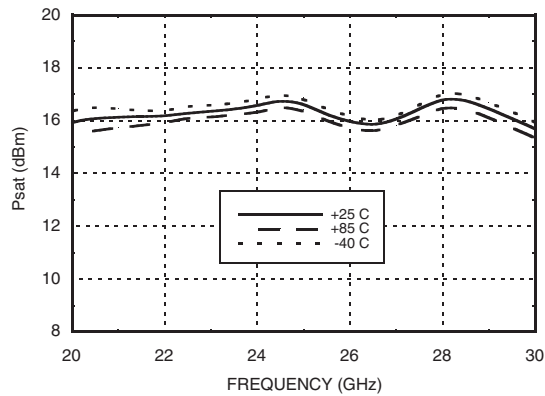

Reverse Isolation vs. Temperature

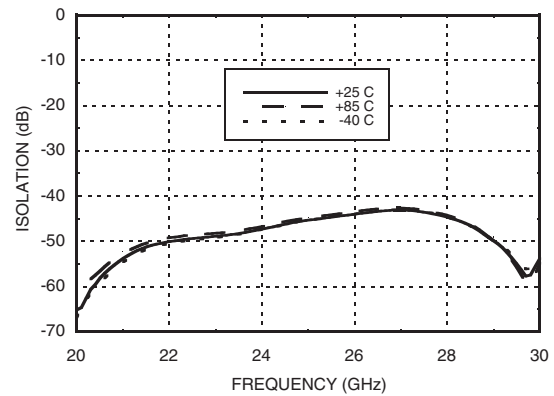



HMC752LC4

GaAs HEMT MMIC LOW NOISE AMPLIFIER, 24 - 28 GHz

Power Compression @ 28 GHz

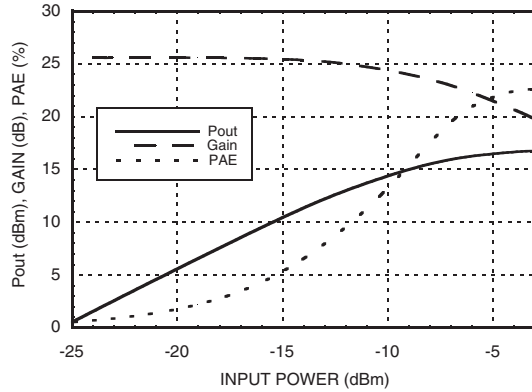

Gain, Noise Figure & P1dB vs. Supply Voltage @ 28 GHz

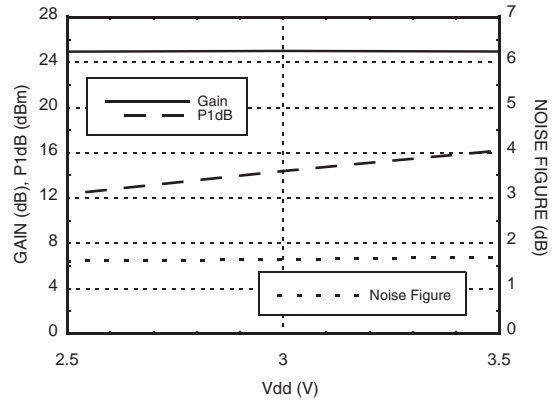

Absolute Maximum Ratings

Drain Bias Voltage	+4.5V
RF Input Power	-5 dBm
Gate Bias Voltage	-1 to 0.3V
Channel Temperature	175 °C
Continuous P _{diss} (T = 85 °C) (derate 6.7 mW/°C above 85 °C)	0.21 W
Thermal Resistance (Channel to ground paddle)	148 °C/W
Storage Temperature	-65 to +150 °C
Operating Temperature	-40 to +85 °C



ELECTROSTATIC SENSITIVE DEVICE
OBSERVE HANDLING PRECAUTIONS

Outline Drawing

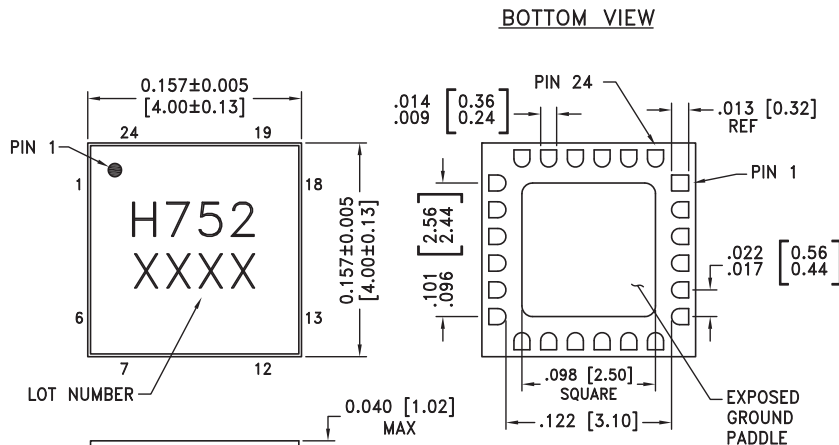

NOTES:

1. PACKAGE BODY MATERIAL: ALUMINA.
2. LEAD AND GROUND PADDLE PLATING: GOLD FLASH OVER NICKEL.
3. DIMENSIONS ARE IN INCHES (MILLIMETERS).
4. LEAD SPACING TOLERANCE IS NON-CUMULATIVE.
5. PACKAGE WARP SHALL NOT EXCEED 0.05MM DATUM $\square-C$.
6. ALL GROUND LEADS AND GROUND PADDLE MUST BE SOLDERED TO PCB RF GROUND.



Pin Descriptions

Pin Number	Function	Description	Interface Schematic
1, 2, 4, 6, 7, 12, 13, 15, 17 - 19, 24	GND	Package bottom has exposed metal paddle that must be connected to RF/DC ground.	
3	RFIN	This pad is AC coupled and matched to 50 Ohms.	
5, 11, 14, 22, 23	N/C	No Connection. This pin may be connected to RF/DC ground. Performance will not be affected.	
8 - 10	Vgg1 - 3	Gate control for amplifier. Please follow "MMIC Amplifier Biasing Procedure" application note. See assembly for required external components.	
16	RFOUT	This pad is AC coupled and matched to 50 Ohms.	
21, 20	Vdd1, Vdd2	Power Supply Voltage for the amplifier. See assembly for required external components.	

Application Circuit

Component	Value
C1 - C5	100 pF
C6 - C10	1,000 pF
C11 - C15	4.7 μF

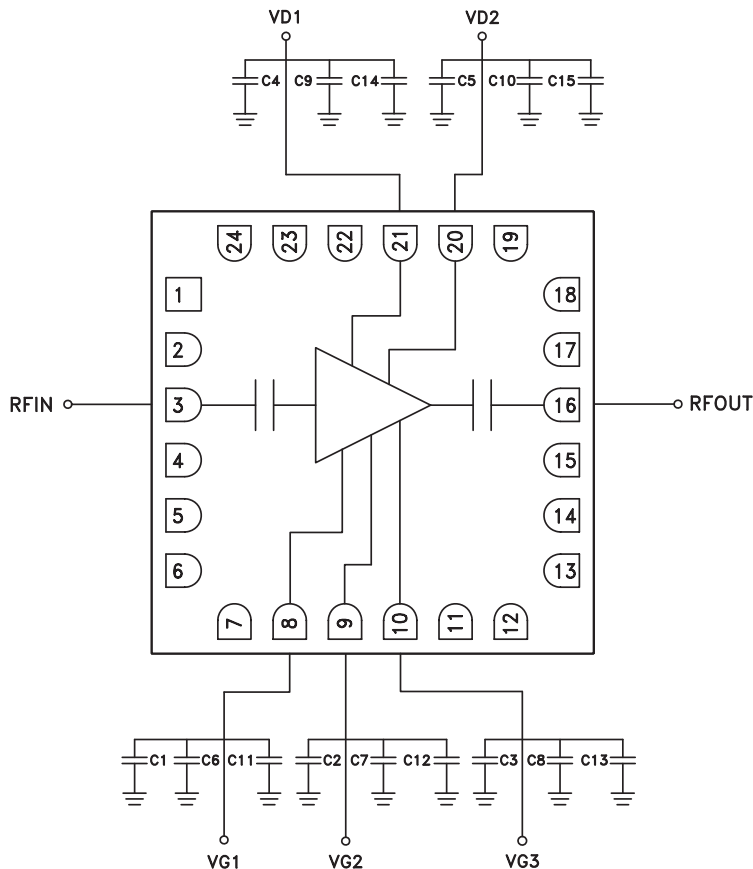

Evaluation PCB

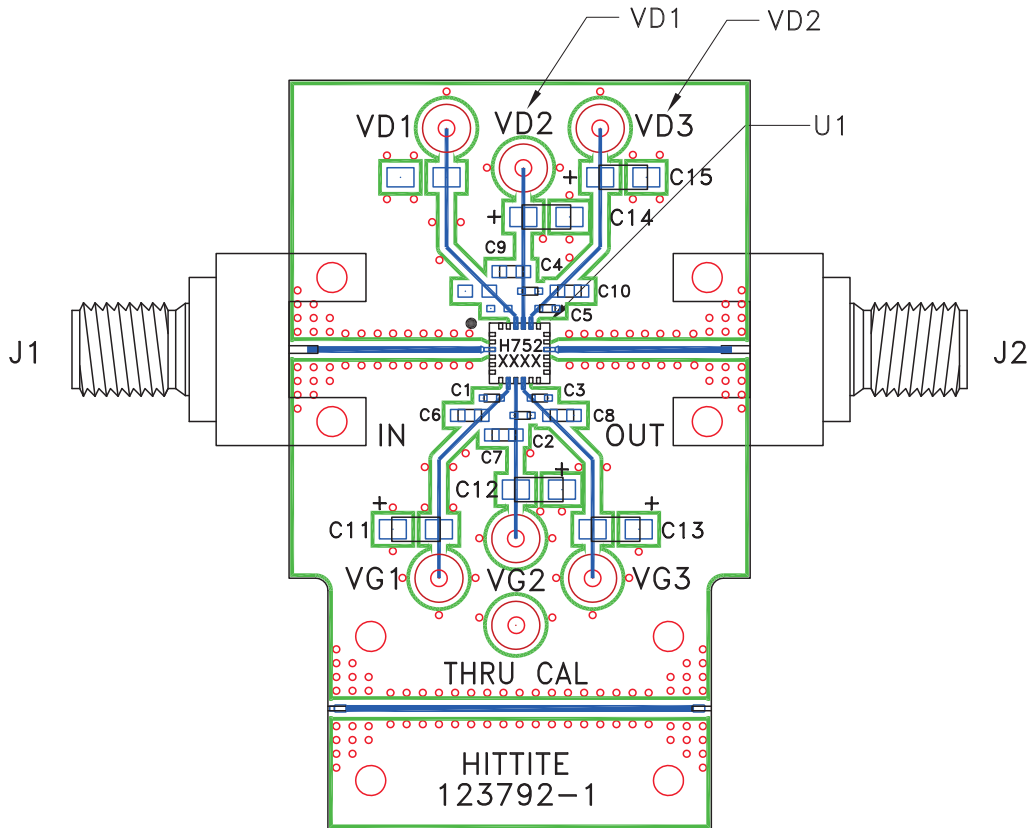

List of Material for Evaluation PCB 123794 [1]

Item	Description
J1, J2	2.92mm PCB mount K-Connector
J3 - J9	DC Pin
C1 - C5	100pF Capacitor, 0402 Pkg.
C6 - C10	1,000pF Capacitor, 0603 Pkg.
C11 - C15	4.7 μ F Capacitor, Tantalum
U1	HMC752LC4 Amplifier
PCB [2]	123792 Evaluation PCB [2]

[1] Reference this number when ordering complete evaluation PCB

[2] Circuit Board Material: Rogers 4350 or Arlon 25FR

The circuit board used in this application should use RF circuit design techniques. Signal lines should have 50 ohm impedance while the package ground leads and exposed paddle should be connected directly to the ground plane similar to that shown. A sufficient number of via holes should be used to connect the top and bottom ground planes. The evaluation board should be mounted to an appropriate heat sink. The evaluation circuit board shown is available from Hittite upon request.