



v01.1105



# HMC473MS8 / 473MS8E

## GaAs MMIC VOLTAGE VARIABLE ATTENUATOR, 0.45 - 2.2 GHz

5

ATTENUATORS - SMT

### Typical Applications

The HMC473MS8 / HMC473MS8E is ideal for:

- Cellular, UMTS/3G Infrastructure
- Portable Wireless
- GPS

### Functional Diagram

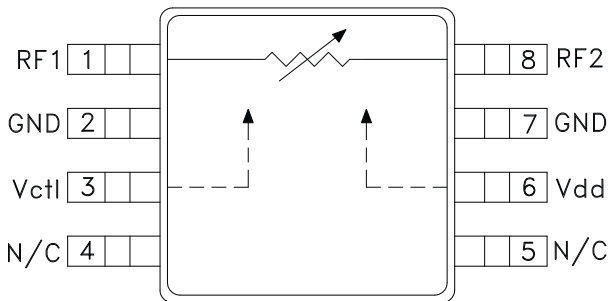

### Features

RoHS Compliant Product

Single Positive Voltage Control: 0 to +3V

High Attenuation Range: 48 dB @ 0.9 GHz

High P1dB Compression Point: +15 dBm

Ultra Small Package: MSOP8

Replaces HMC173MS8

### General Description

The HMC473MS8 & HMC473MS8E are general purpose absorptive voltage variable attenuators in 8-lead MSOP packages. The devices operate with a +3.3V supply voltage and a 0 to +3V control voltage. Unique features include a high dynamic attenuation range of up to 48 dB and excellent power handling performance through all attenuation states. The HMC473MS8 & HMC473MS8E are ideal for operation in wireless applications from 0.45 to 1.6 GHz. Operation from 1.7 to 2.2 GHz is possible with a reduced maximum attenuation of 29 to 32 dB. Improved control voltage linearity vs. attenuation can be achieved with an external driver circuit.

### Electrical Specifications, $T_A = +25^\circ\text{C}$ , $V_{dd} = +3.3\text{Vdc}$ , 50 Ohm System

Parameter		Min.	Typ.	Max.	Units
Insertion Loss (Min. Atten.) ( $V_{ctl} = 0.0\text{Vdc}$ )	0.45 - 0.8 GHz		1.8	2.2	dB
	0.8 - 1.0 GHz		1.9	2.3	dB
	1.0 - 1.6 GHz		2.4	2.9	dB
	1.6 - 2.0 GHz		2.8	3.3	dB
	2.0 - 2.2 GHz		3.0	3.5	dB
Attenuation Range ( $V_{ctl} = 0\text{ to }+3\text{V}$ )	0.45 - 0.8 GHz	34	39		dB
	0.8 - 1.0 GHz	43	48		dB
	1.0 - 1.6 GHz	32	37		dB
	1.6 - 2.0 GHz	27	32		dB
	2.0 - 2.2 GHz	24	29		dB
Return Loss ( $V_{ctl} = 0\text{ to }+3\text{V}$ )	0.45 - 0.8 GHz		15		dB
	0.8 - 1.0 GHz		14		dB
	1.0 - 1.6 GHz		11		dB
	1.6 - 2.0 GHz		10		dB
	2.0 - 2.2 GHz		9		dB
Input Power for 0.1 dB Compression (0.9 GHz)	Min Atten.		20		dBm
	Atten. >2.0		5.5		dBm
Input Power for 1.0 dB Compression (0.9 GHz)	Min Atten.	24	28		dBm
	Atten. >2.0	11	15		dBm
Input Third Order Intercept (0.9 GHz, Two-tone Input Power = +5.0 dBm Each Tone)	Min Atten.		47		dBm
	Atten. >2.0		20		dBm
Switching Characteristics tRISE, tFALL (10/90% RF) tON, tOFF (50% CTL to 10/90% RF)	0.45 - 2.2 GHz		1.3		$\mu\text{S}$
			1.5		$\mu\text{S}$

For price, delivery, and to place orders, please contact Hittite Microwave Corporation:  
20 Alpha Road, Chelmsford, MA 01824 Phone: 978-250-3343 Fax: 978-250-3373

Order On-line at [www.hittite.com](http://www.hittite.com)

SUNSTAR射频通信 <http://www.rfoe.net/> TEL:0755-83397033 FAX:0755-83376182 E-MAIL: szss20@163.com



## HMC473MS8 / 473MS8E

### GaAs MMIC VOLTAGE VARIABLE ATTENUATOR, 0.45 - 2.2 GHz

5

ATTENUATORS - SMT

**Insertion Loss vs. Temperature**

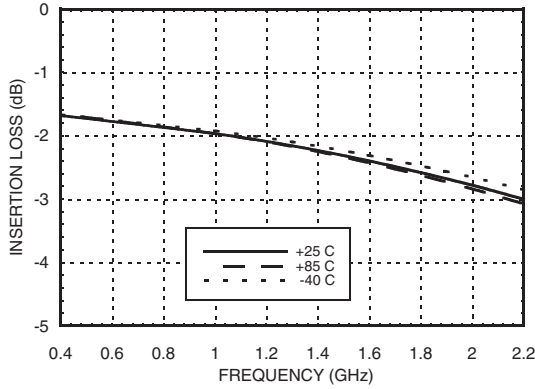

**Return Loss vs. Control Voltage**

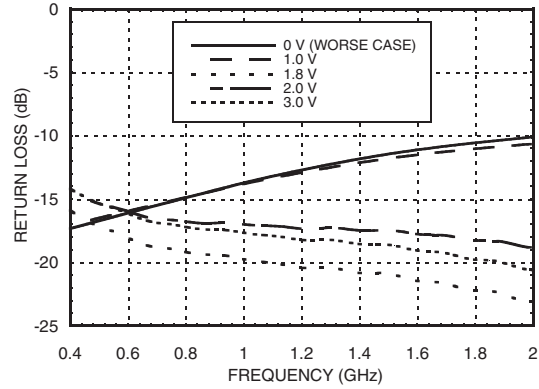

**Input IP3 vs. Control Voltage @ 0.45 GHz**

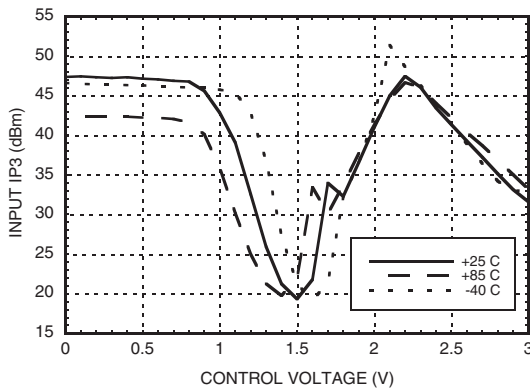

**Input IP3 vs. Control Voltage @ 0.9 GHz**

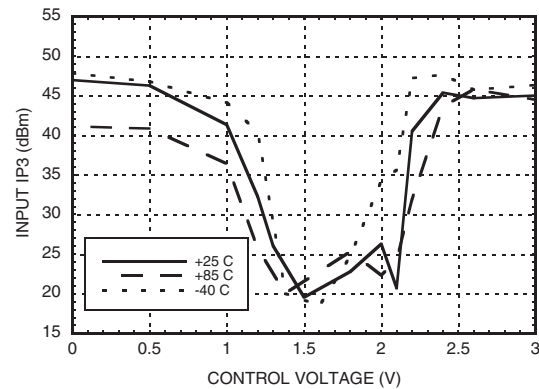

**Input IP3 vs. Control Voltage @ 1.9 GHz**

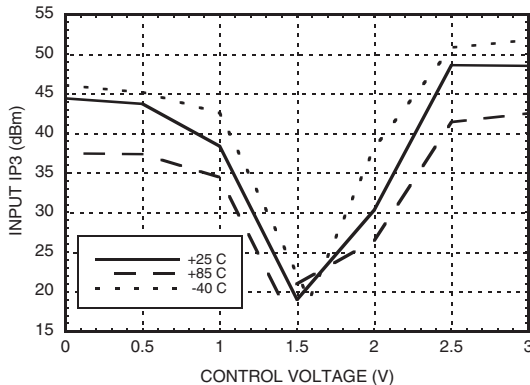

**Input IP3 vs. Control Voltage @ 2.1 GHz**

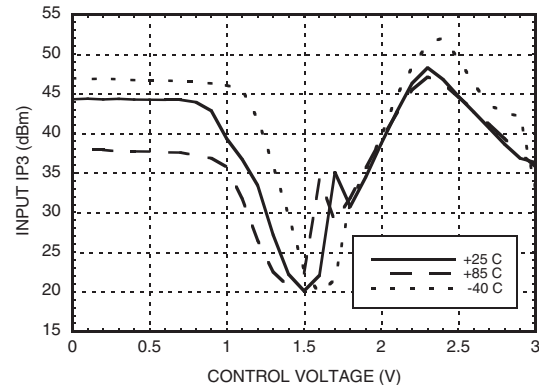

For price, delivery, and to place orders, please contact Hittite Microwave Corporation:  
20 Alpha Road, Chelmsford, MA 01824 Phone: 978-250-3343 Fax: 978-250-3373

Order On-line at [www.hittite.com](http://www.hittite.com)



v01.1105



## HMC473MS8 / 473MS8E

### GaAs MMIC VOLTAGE VARIABLE ATTENUATOR, 0.45 - 2.2 GHz

5

ATTENUATORS - SMT

**Relative Attenuation vs. Control Voltage @ 0.45 GHz**

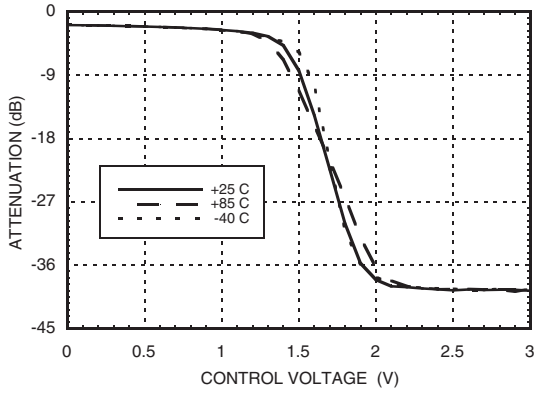

**Return Loss vs. Control Voltage @ 0.45 GHz**

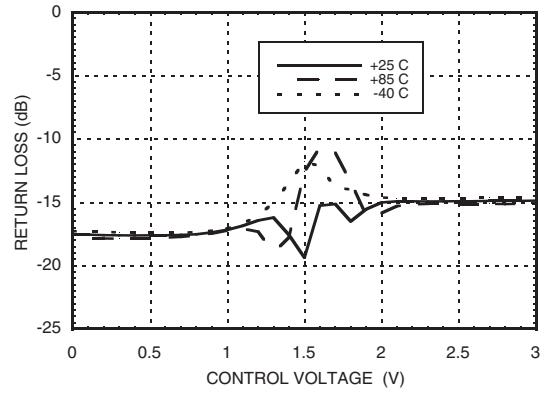

**Relative Attenuation vs. Control Voltage @ 0.9 GHz**

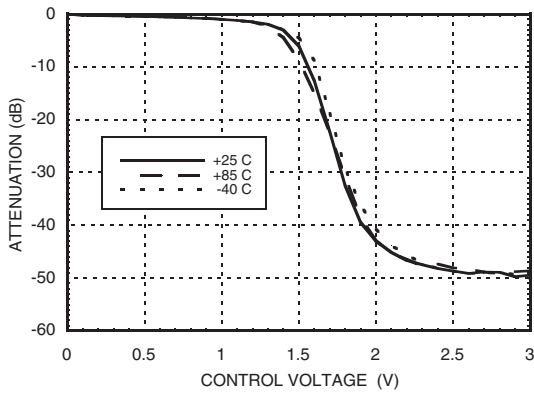

**Return Loss vs. Control Voltage @ 0.9 GHz**

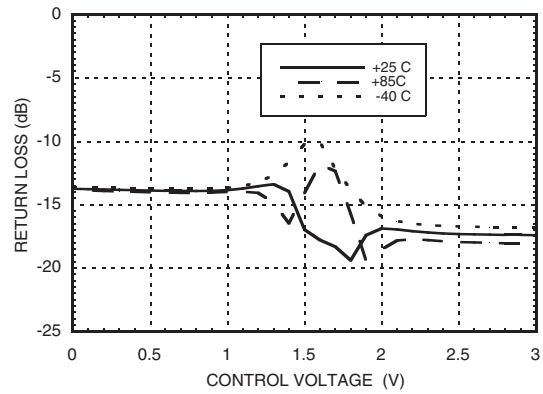

**Relative Attenuation vs. Control Voltage @ 1.9 GHz**

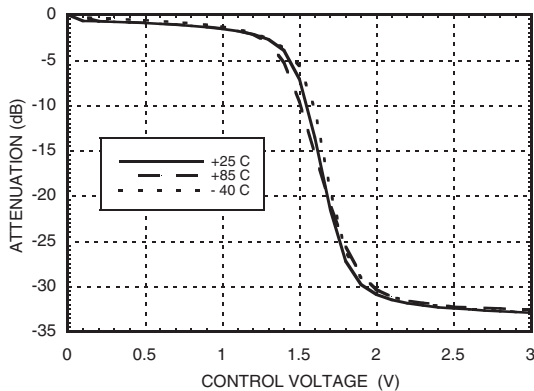

**Return Loss vs. Control Voltage @ 1.9 GHz**

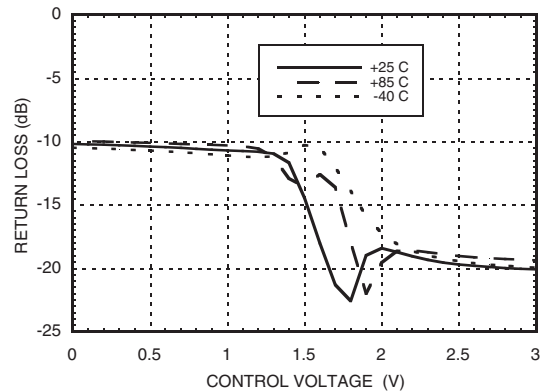

For price, delivery, and to place orders, please contact Hittite Microwave Corporation:  
20 Alpha Road, Chelmsford, MA 01824 Phone: 978-250-3343 Fax: 978-250-3373

Order On-line at [www.hittite.com](http://www.hittite.com)



## HMC473MS8 / 473MS8E

### GaAs MMIC VOLTAGE VARIABLE ATTENUATOR, 0.45 - 2.2 GHz

**Relative Attenuation vs. Control Voltage @ 2.1 GHz**

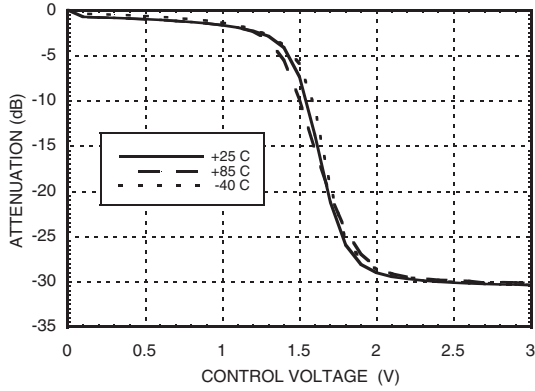

**Return Loss vs. Control Voltage @ 2.1 GHz**

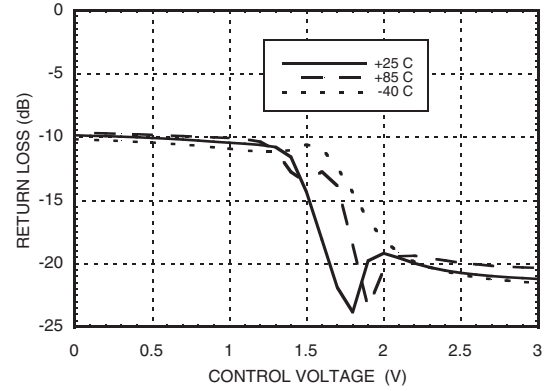

**Relative Attenuation vs. Control Voltage**

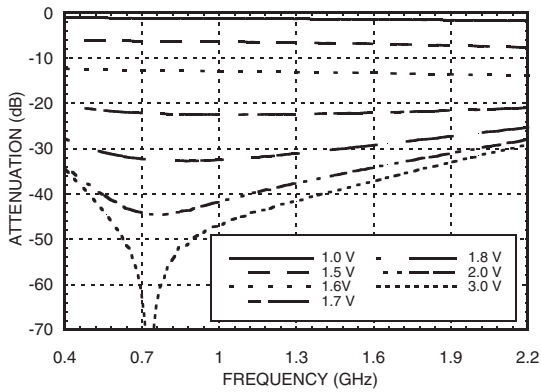

**Worse Case Input P1dB vs. Temperature**

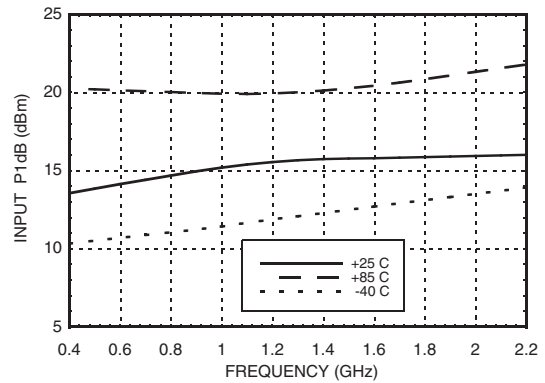

For price, delivery, and to place orders, please contact Hittite Microwave Corporation:  
20 Alpha Road, Chelmsford, MA 01824 Phone: 978-250-3343 Fax: 978-250-3373

Order On-line at [www.hittite.com](http://www.hittite.com)



# HMC473MS8 / 473MS8E

## GaAs MMIC VOLTAGE VARIABLE ATTENUATOR, 0.45 - 2.2 GHz

5

ATTENUATORS - SMT

### Absolute Maximum Ratings

V <sub>CTL</sub>	-0.2 Vdc to Vdd	
Vdd	+8 Vdc	
Maximum Input Power Vdd = +3.3 Vdc	+29 dBm	Min. Atten. Attenuation >2 dB
Channel Temperature (Tc)	150 °C	
Thermal Resistance (R <sub>TH</sub> ) (junction to lead)	92 °C/W	
Storage Temperature	-65 to +150 °C	
Operating Temperature	-40 to +85 °C	
ESD Sensitivity (HBM)	Class 1A	

### Control and Bias Voltage

V <sub>CTL</sub>	0 to +3 Vdc @ 1 μA
Vdd	+3.3 Vdc ± 0.1 Vdc @ 10 μA



ELECTROSTATIC SENSITIVE DEVICE  
OBSERVE HANDLING PRECAUTIONS

### Outline Drawing

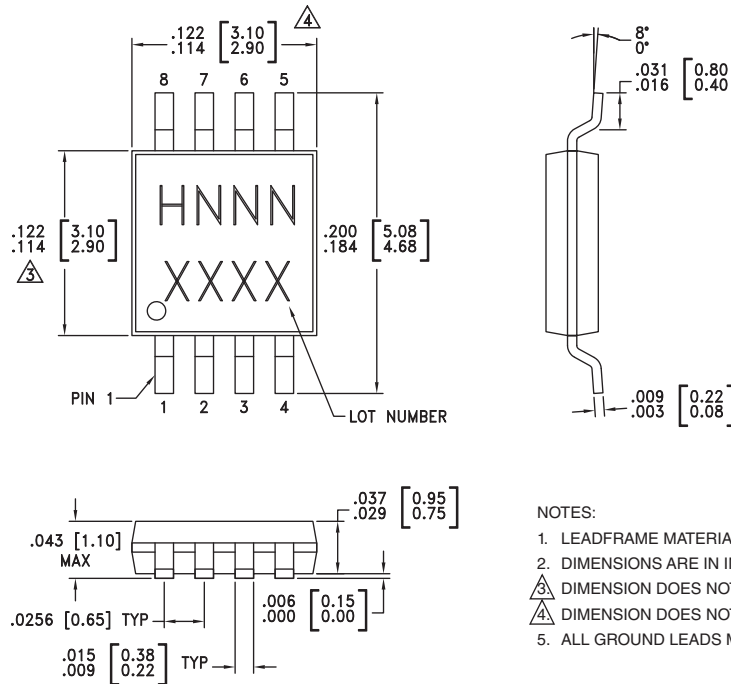

NOTES:

1. LEADFRAME MATERIAL: COPPER ALLOY
2. DIMENSIONS ARE IN INCHES [MILLIMETERS].
3. DIMENSION DOES NOT INCLUDE MOLDFLASH OF 0.15mm PER SIDE.
4. DIMENSION DOES NOT INCLUDE MOLDFLASH OF 0.25mm PER SIDE.
5. ALL GROUND LEADS MUST BE SOLDERED TO PCB RF GROUND.

### Package Information

Part Number	Package Body Material	Lead Finish	MSL Rating	Package Marking <sup>[3]</sup>
HMC473MS8	Low Stress Injection Molded Plastic	Sn/Pb Solder	MSL1 <sup>[1]</sup>	H473 XXXX
HMC473MS8E	RoHS-compliant Low Stress Injection Molded Plastic	100% matte Sn	MSL1 <sup>[2]</sup>	H473 XXXX

[1] Max peak reflow temperature of 235 °C

[2] Max peak reflow temperature of 260 °C

[3] 4-Digit lot number XXXX

For price, delivery, and to place orders, please contact Hittite Microwave Corporation:  
20 Alpha Road, Chelmsford, MA 01824 Phone: 978-250-3343 Fax: 978-250-3373

Order On-line at [www.hittite.com](http://www.hittite.com)



v01.1105



## HMC473MS8 / 473MS8E

### GaAs MMIC VOLTAGE VARIABLE ATTENUATOR, 0.45 - 2.2 GHz

5

#### Pin Descriptions

Pin Number	Function	Description	Interface Schematic
1, 8	RF1, RF2	These pins are DC coupled and matched to 50 Ohms. DC blocking capacitors are required. 330pF capacitors are supplied on evaluation board.	
2, 7	GND	Pins must connect to RF ground.	
3	Vctl	Control voltage	
4, 5	N/C	No Connection. These pins may be connected to RF ground. Performance will not be affected.	
6	Vdd	Supply Voltage.	

ATTENUATORS - SMT

For price, delivery, and to place orders, please contact Hittite Microwave Corporation:  
20 Alpha Road, Chelmsford, MA 01824 Phone: 978-250-3343 Fax: 978-250-3373

Order On-line at [www.hittite.com](http://www.hittite.com)

SUNSTAR射频通信 <http://www.rfoe.net/> TEL:0755-83397033 FAX:0755-83376182 E-MAIL: szss20@163.com



v01.1105



## HMC473MS8 / 473MS8E

### GaAs MMIC VOLTAGE VARIABLE ATTENUATOR, 0.45 - 2.2 GHz

5

ATTENUATORS - SMT

#### Attenuation Linearizing Control Circuit

#### For The HMC473MS8 / HMC473MS8E Voltage Variable Attenuator

A driver circuit to improve the attenuation linearity of the HMC473MS8 & HMC473MS8E can be implemented with a simple op-amp configuration. A *breakpoint* linearization circuit will scale the voltage supplied to the control line of the HMC473MS8 & HMC473MS8E, so that a more linear attenuation vs. control voltage slope can be achieved. A -3.3V and +3.3V supply is required.

Diode and resistor values which define the op-amp gain, and breakpoint were selected to optimize a measured production lot of attenuators at 0.9 GHz. R7 may be varied to optimize the performance of any given attenuator. If the input voltage to the linearizing circuit will not drop below 1.0V, the R9 and D2 may be omitted, and this will greatly reduce the overall power consumption of the driver circuit.

The linearizing circuit has been optimized for 0.9 GHz attenuation applications. A similar approach may be used at other frequencies by adjusting R1 - R9 resistor values.

#### Application Circuit

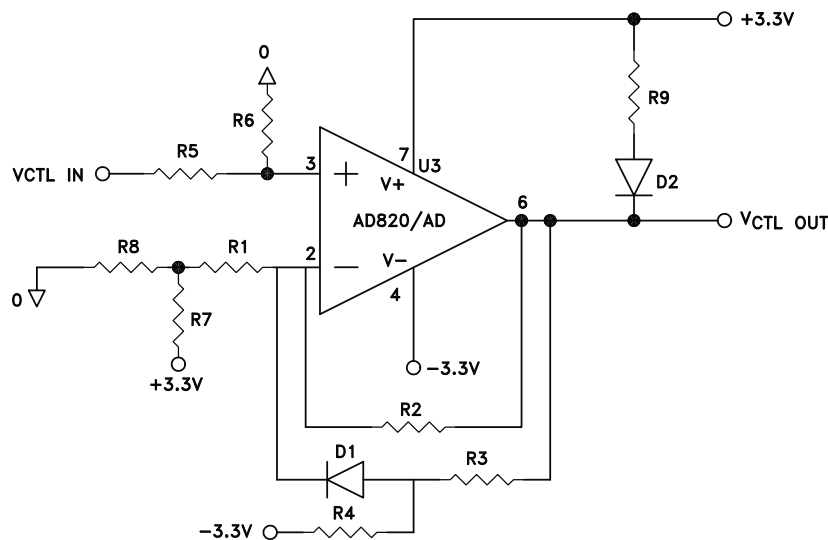

#### Required Parts List

Part	Description	Manufacturer
AD822	Op-Amp	Analog Devices
R1	10K ohms	Panasonic
R2	200K ohms	Panasonic
R3	7.5K ohms	Panasonic
R4	39K ohms	Panasonic
R5	220K ohms	Panasonic
R6	91K ohms	Panasonic
R7	910 ohms	Panasonic
R8	51 ohms	Panasonic
R9	100 ohms	Panasonic
D1, D2	LL4148 D-35	Digi-Key

For price, delivery, and to place orders, please contact Hittite Microwave Corporation:  
20 Alpha Road, Chelmsford, MA 01824 Phone: 978-250-3343 Fax: 978-250-3373

Order On-line at [www.hittite.com](http://www.hittite.com)

SUNSTAR射频通信 <http://www.rfoe.net/> TEL:0755-83397033 FAX:0755-83376182 E-MAIL: szss20@163.com



## HMC473MS8 / 473MS8E

**GaAs MMIC VOLTAGE VARIABLE  
ATTENUATOR, 0.45 - 2.2 GHz**

### Evaluation PCB

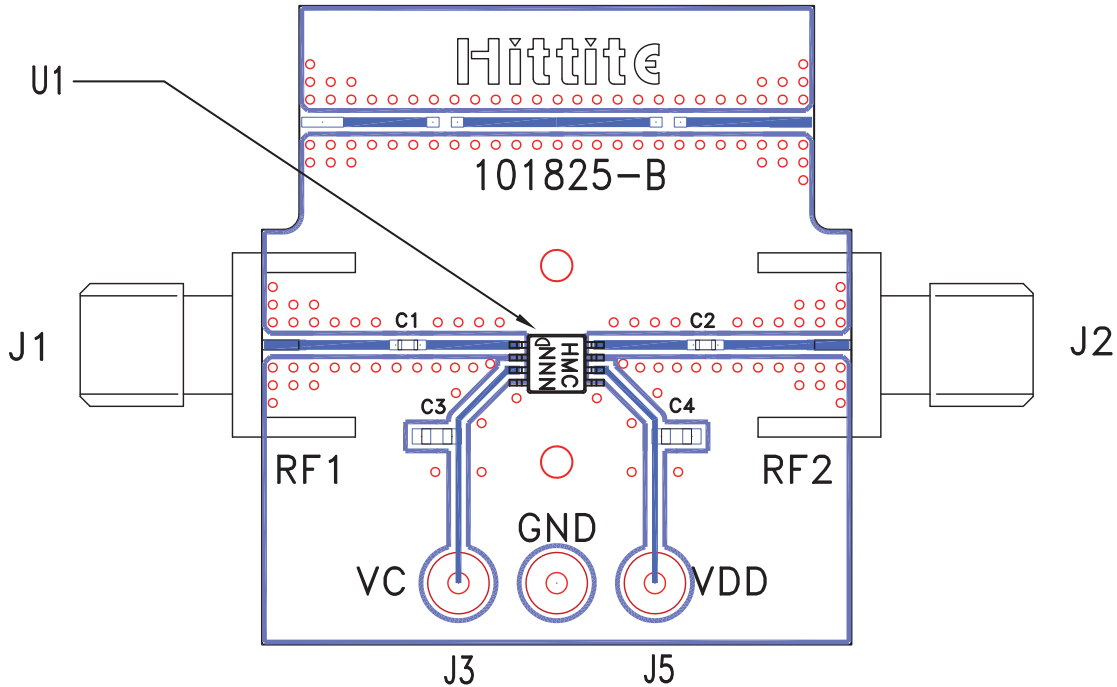

### List of Materials for Evaluation PCB 101827 [1]

Item	Description
J1 - J2	PCB Mount SMA RF Connector
J3 - J5	DC PIN
C1, C2	330pF capacitor, 0402 Pkg.
C3, C4	10KpF capacitor, 0603 Pkg.
U1	HMC473MS8 / HMC473MS8E
PCB [2]	101825 Eval Board

[1] Reference this number when ordering complete evaluation PCB

[2] Circuit Board Material: Rogers 4350

The circuit board used in the final application should be generated with proper RF circuit design techniques. Signal lines at the RF ports should be 50 ohm impedance and the package ground leads should be connected directly to the PCB RF ground plane, similar to that shown above. The evaluation circuit board shown above is available from Hittite Microwave Corporation upon request.

For price, delivery, and to place orders, please contact Hittite Microwave Corporation:  
20 Alpha Road, Chelmsford, MA 01824 Phone: 978-250-3343 Fax: 978-250-3373

Order On-line at [www.hittite.com](http://www.hittite.com)  
SUNSTAR射频通信 <http://www.rfoe.net/> TEL:0755-83397033 FAX:0755-83376182 E-MAIL: szss20@163.com