

VFTX100

TCXO Low Noise to 1.0 GHz

25.4x22mm SMD, PECL/LVPECL

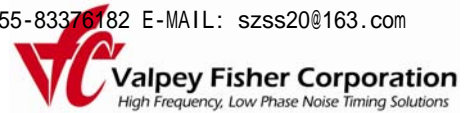

Features

- 200MHz to 1.0 GHz Frequency Range
- Ultra Low Jitter and Phase Noise: -118 dBc/Hz @ 1KHz
- Excellent frequency stability < 1ppm
- Low Power: <220mW typical

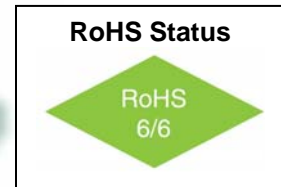
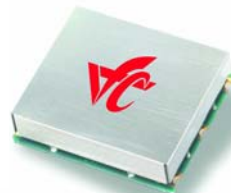

Applications

- Sonet / SDH / ATM
- 10 Gigabit Ethernet
- Digital Wireless Reference

Description

The VFTX100 is a low noise TCXO capable of providing an output frequency up to 1GHz. The temperature stability is less than 1ppm over a temperature range of -40°C to +85°C. Operating with a +3.3 volt power supply the device typically consumes 220 mW. The device contains an internal voltage regulator for improved stability and noise performance. The output is configured as a differential LVPECL signal and requires external termination resistors. The VFTX100 is available in a 25.4mm x 22mm surface mount package.

Replaces Valpey Fisher Part Number: VFT7H

Electrical Specifications

Parameter	Symbol	Condition	Min	Typ	Max	Unit	Note
Frequency Range	F		200		1,000	MHz	
Frequency Stability	$\Delta F/F$	Vs. Operating Temperature B: 0°C to +70°C G: -40°C to +85°C		0.5 0.8	1.0 1.0	ppm	
		Vs. Supply Voltage Vs. Aging / Year Vs. Aging / 10 Years		± 0.1 ± 1 ± 3		ppm/V ppm ppm	First Year 10 Years
Operating Temperature Range	T		0° -40°		+70° +85°	°C	Order Code B Order Code G
Output		PECL / LVPECL					
Supply Voltage	Vcc		4.75 3.15	5.00 3.30	5.25 3.45	V	Order Code D Order Code E
Voltage Control	Vc		0 0		5 3.3	V	
Input Impedance			50K			Ω	
APR			± 5			ppm	
Deviation slope		Monotonic positive					
Linearity			-10		+10	ppm/V	
Modulation BW			10			Hz	3dB BW



VFTX100

TCXO Low Noise to 1.0 GHz

25.4x22mm SMD, PECL/LVPECL

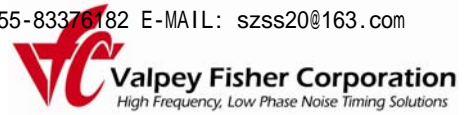

Electrical Specifications

Parameter	Symbol	Condition	Min	Typ	Max	Unit	Note
Input Current	Icc	50 Ohm Load		62	75	mA	
Load	50 Ohm to Vcc-2V or Thevenin Equivalent						
Duty Cycle		@ 50%	45	50	55	%	
Rise / Fall Time	Tr/Tf	20% to 80%			0.6	ns	
Logic "1" Level	Voh		Vcc-0.96		Vcc-0.81	V	
Logic "0" Level	Vol		Vcc-1.85		Vcc-1.65	V	
Start up time				2	10	ms	
Phase Jitter		12KHz to 20MHz		0.25	0.5	ps	
SSB Phase Noise		100Hz 1KHz 10KHz 100KHz		-90 -118 -142 -145		dBc/Hz	@ 622.08 MHz
Setability					0.1	ppm	
Setability Voltage			1.3		1.7	V	
Enable / Disable Function	Input HIGH (>2.5V): DISABLED Input LOW (<0.5V) or floating: ACTIVE					LVCMOS	
Enable / Disable Time	Te/Td				100	ns	

How to Order

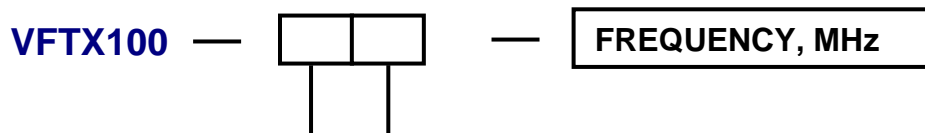

Temperature Range	
Code	Specification
B	0°C to 70°C
G	-40°C to 85°C

Supply Voltage	
Code	Specification
D	5V ± 5%
E	3.3V ± 5%



VFTX100

TCXO Low Noise to 1.0 GHz

25.4x22mm SMD, PECL/LVPECL

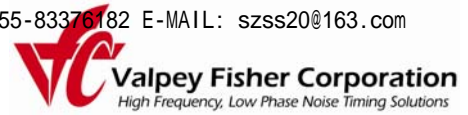

Absolute Maximum Ratings

Parameter	Symbol	Condition	Min	Typ	Max	Unit	Note
Supply Break Down Voltage	Vcc		-0.5		5.5	V	
Storage Temperature	Ts		-55		+105	°C	
Control Voltage	Vc		-0.5		6	V	

Environmental and Mechanical

Parameter	Specification
Mechanical Shock	Per MIL-STD-202, Method 213, Condition E
Thermal Shock	Per MIL-STD-883, Method 1011, Condition A
Vibration	Per MIL-STD-883, Method 2007, Condition A
Soldering Conditions	260°C for 10s max
Hermetic Seal	Leak rate less than 5×10^{-8} atm.cc/s of helium (crystal only)

Connection Diagram

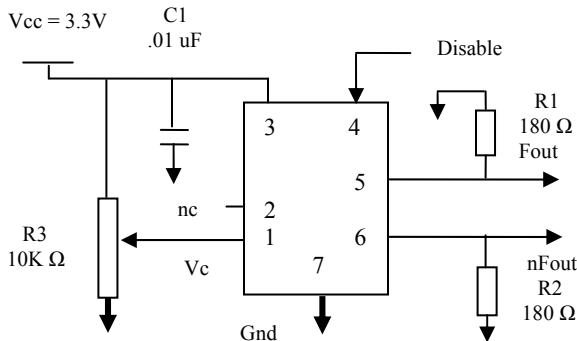

Pin #	Connection
1	Vc
2	N/C
3	Vcc
4	N/C
5	Output
6	Output
7	GND

Mechanical Outline

