

# VFJA210

## Jitter Attenuator

### 20mm x 20mm SMD, Sine Output

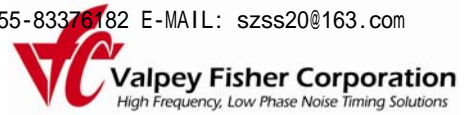

#### Features

- 1.3 GHz Output Frequency
- Sine Wave Output
- Ultra Low Jitter: < 0.20 ps
- Low Profile SMD package

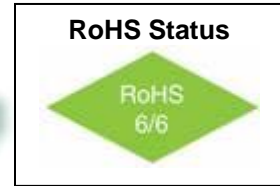
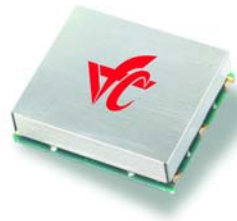

#### Applications

- Wireless Reference
- Access Communication

#### Description

The VFJA210 is a Jitter Attenuator which provides an output frequency up to 1.3 GHz. An internal synthesizer locks to the input reference clock and multiplies it up to the desired output frequency. The output frequency is determined by a VCXO designed for extremely low phase noise. The output signal is delivered as a sine wave matched for a 50 ohm load. The VFJA210 is available in a 20 mm x 20 mm surface mount package.

#### Electrical Specifications

Parameter	Symbol	Condition	Min	Typ	Max	Unit	Note
Input Frequency	Fin	Slew Rate 2.5V / ns (min)	10		250	MHz	See Table 1
Output Frequency	Fout		200		1300	MHz	
Operating Temperature Range	Ta		-40°		+85°	°C	
Supply Voltage	Vcc		3.15	3.30	3.45	V	
Supply Current	Icc	50 Ohm Load		75	85	mA	
Jitter		12KHz to 20MHz		0.2	.4	ps (rms)	
SSB Phase Noise		100Hz 1KHz 10KHz 100KHz 1 MHz		-80 -108 -130 -139 -142		dBc/Hz	@ 1.2 GHz
Subharmonics		50 Ω Load		-40	-36	dBc	
Modulation Bandwidth	MBW			10		Hz	
Load	50 Ohm						
Output Power	Po		5	8	11	dBm	
Lock Range			12			ppm	Note 1
Input Level		AC coupled internally	1.0		3.3	V p-p	
Start Up Time				3		ms	

Note 1: Consult factory for additional lock range options.

# VFJA210

## Jitter Attenuator

### 20mm x 20mm SMD, Sine Output

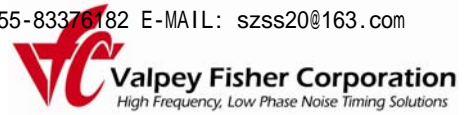

#### Absolute Maximum Ratings

Parameter	Symbol	Condition	Min	Typ	Max	Unit	Note
Supply Voltage	Vcc		-0.5		+5.5	V	
Storage Temperature	Ts		-55		+105°	°C	

#### Environmental and Mechanical

Parameter	Specification
Mechanical Shock	Per MIL-STD-202, Method 213, Condition E
Thermal Shock	Per MIL-STD-883, Method 1011, Condition A
Vibration	Per MIL-STD-883, Method 2007, Condition A
Soldering Conditions	260°C for 10s max
Hermetic Seal	Leak rate less than $5 \times 10^{-8}$ atm.cc/s of helium (crystal only)

#### Pin Assignments

Pin #	Description	Pin #	Description
1	Fin	16	Fout
2	Vcc	15	Gnd
3	S1	14	Gnd
4	Do Not Connect	13	Vcc
5	Do Not Connect	12	Gnd
6	S0	11	Gnd
7	Vcc	10	Gnd
8	Gnd	9	Vcc

# VFJA210

## Jitter Attenuator

### 20mm x 20mm SMD, Sine Output

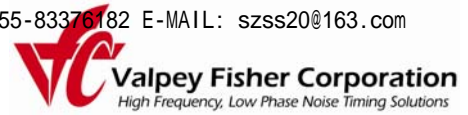

### How to Order

VFJA210 — Suffix

Standard Frequencies **Table 1**

P/N suffix	S1:S0	Input Frequency (MHz)	Output Frequency (MHz)	P/N suffix	S1:S0	Input Frequency (MHz)	Output Frequency (MHz)
-001	00	100.00	450.00	-002	00	100.00	800.00
	01	100.00	450.00		01	100.00	800.00
	10	100.00	450.00		10	100.00	800.00
	11	100.00	450.00		11	100.00	800.00
-003	00	100.00	1050.00	-004	00	100.00	1300.00
	01	100.00	1050.00		01	100.00	1300.00
	10	100.00	1050.00		10	100.00	1300.00
	11	100.00	1050.00		11	100.00	1300.00
-005	00	10.00	1000.00				
	01	10.00	1000.00				
	10	10.00	1000.00				
	11	10.00	1000.00				

Once Input and Output frequencies have been submitted and approved, the Factory will assign a part number.

# VFJA210

## Jitter Attenuator

### 20mm x 20mm SMD, Sine Output

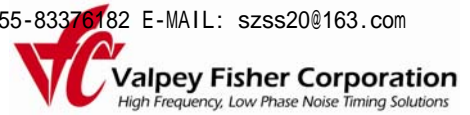

#### Connection Diagram

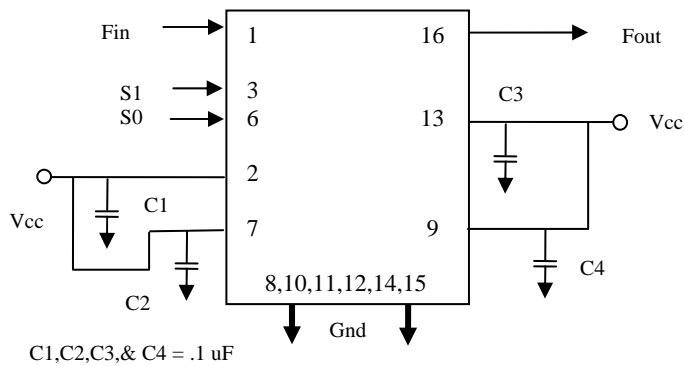

#### Mechanical Outline

