

InGaP HBT GAIN BLOCK MMIC AMPLIFIER, DC - 4.5 GHz



Typical Applications

The HMC475ST89 / HMC475ST89E is an ideal RF/IF gain block & LO or PA driver:

- Cellular / PCS / 3G
- Fixed Wireless & WLAN
- CATV, Cable Modem & DBS
- Microwave Radio & Test Equipment
- IF and RF Applications

Features

- P1dB Output Power: +22 dBm
- Gain: 21.5 dB
- Output IP3: +35 dBm
- Cascadable 50 Ohm I/Os
- Single Supply: +8V to +12V
- Industry Standard SOT89 Package

Functional Diagram

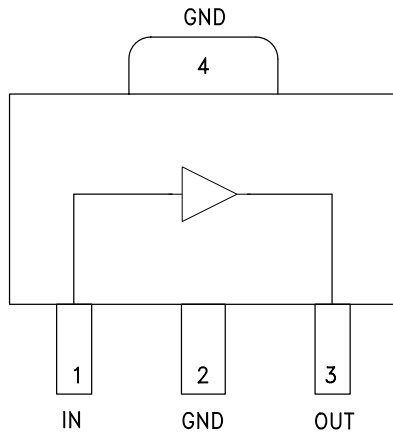

General Description

The HMC475ST89(E) is a InGaP Heterojunction Bipolar Transistor (HBT) Gain Block MMIC SMT amplifier covering DC to 4.5 GHz. Packaged in an industry standard SOT89, the amplifier can be used as a cascadable 50 Ohm RF/IF gain stage as well as a LO or PA driver with up to +25 dBm output power. The HMC475ST89(E) offers 21.5 dB of gain and +35 dBm output IP3 at 850 MHz while requiring only 110 mA from a single positive supply. The Darlington topology results in reduced sensitivity to normal process variations and excellent gain stability over temperature while requiring a minimal number of external bias components.

Electrical Specifications, $V_s = 8.0\text{ V}$, $R_{bias} = 9.1\text{ Ohm}$, $T_A = +25^\circ\text{ C}$

Parameter		Min.	Typ.	Max.	Units
Gain	DC - 1.0 GHz	19.5	21.5		dB
	1.0 - 2.0 GHz	17.5	19.5		dB
	2.0 - 3.0 GHz	14.5	16.5		dB
	3.0 - 4.0 GHz	11.5	13.5		dB
	4.0 - 4.5 GHz	9	12		dB
Gain Variation Over Temperature	DC - 4.5 GHz		0.008	0.012	dB/ °C
Input Return Loss	DC - 1.0 GHz		11		dB
	1.0 - 2.0 GHz		14		dB
	2.0 - 4.5 GHz		14		dB
Output Return Loss	DC - 1.0 GHz		13		dB
	1.0 - 4.5 GHz		10		dB
Reverse Isolation	DC - 4.5 GHz		25		dB
Output Power for 1 dB Compression (P1dB)	DC - 1.0 GHz	19.0	22.0		dBm
	1.0 - 2.0 GHz	18.0	21.0		dBm
	2.0 - 3.0 GHz	17.5	19.5		dBm
	3.0 - 4.0 GHz	13.0	16.0		dBm
	4.0 - 4.5 GHz	11.0	14.0		dBm
Output Third Order Intercept (IP3) (Pout= 0 dBm per tone, 1 MHz spacing)	DC - 2.5 GHz		35		dBm
	2.5 - 4.5 GHz		30		dBm
Noise Figure	DC - 3.0 GHz		3.5		dB
	3.0 - 4.5 GHz		3.8		dB
Supply Current (Icc)			110	135	mA

Note: Data taken with broadband bias tee on device output.



HMC475ST89 / 475ST89E

InGaP HBT GAIN BLOCK MMIC AMPLIFIER, DC - 4.5 GHz

Broadband Gain & Return Loss

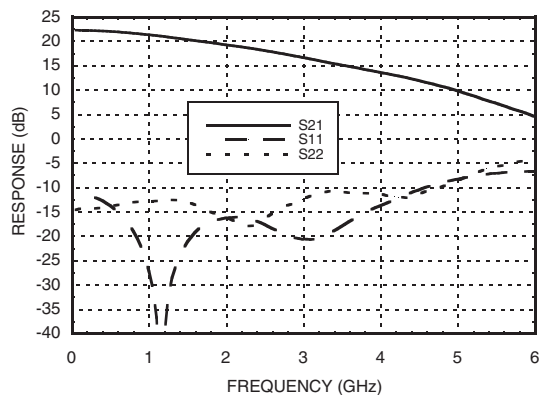

Gain vs. Temperature

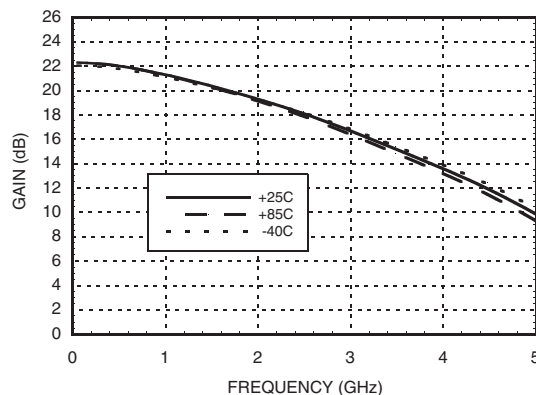

Input Return Loss vs. Temperature

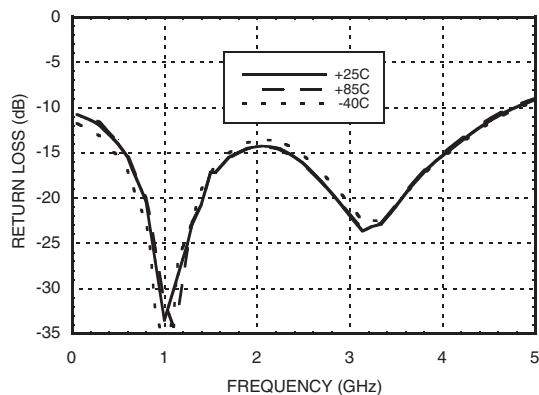

Output Return Loss vs. Temperature

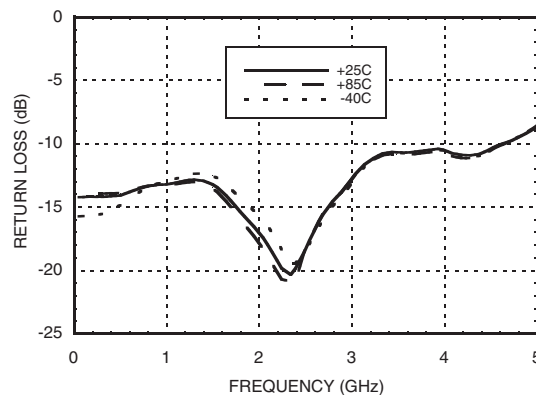

Reverse Isolation vs. Temperature

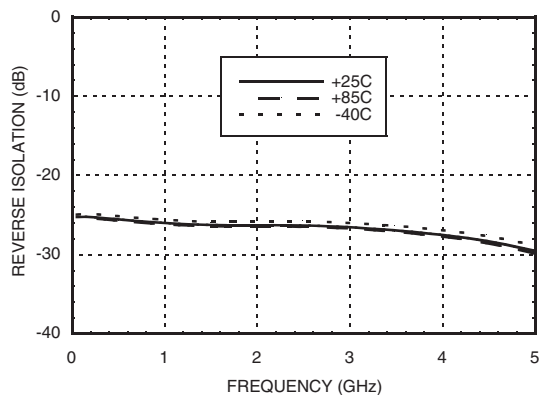

Noise Figure vs. Temperature

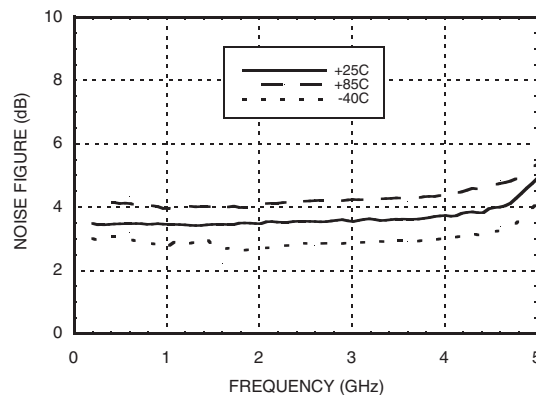



P1dB vs. Temperature

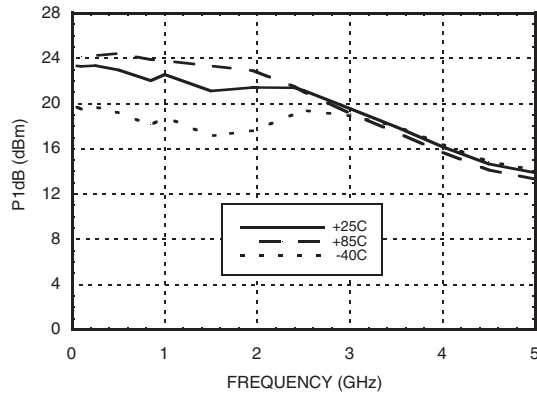

Psat vs. Temperature

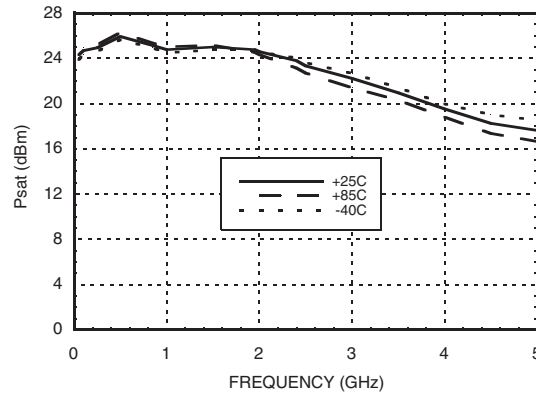

Output IP3 vs. Temperature

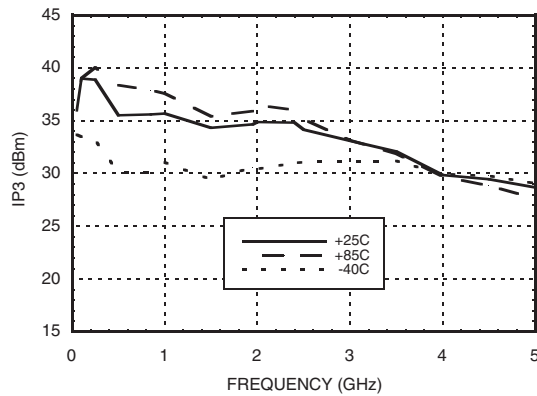

Gain, Power & OIP3 vs. Supply Voltage for Constant Icc= 110 mA @ 850 MHz

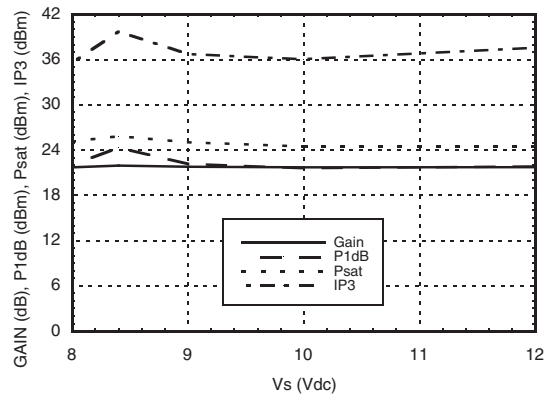

Vcc vs. Icc Over Temperature for Fixed Vs= 8V, RBIAS= 9.1 Ohms

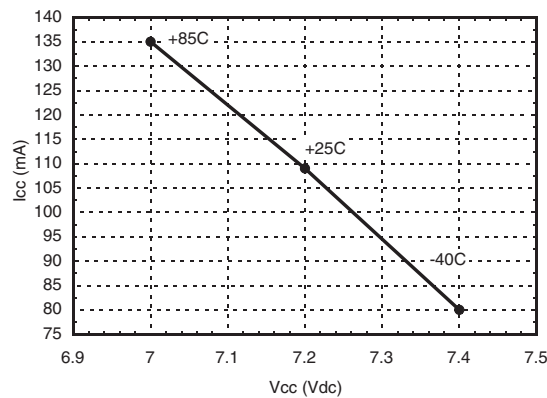



Absolute Maximum Ratings

Collector Bias Voltage (Vcc)	+8.0 Vdc
RF Input Power (RFIN)(Vcc = +7.2 Vdc)	+17 dBm
Junction Temperature	150 °C
Continuous P _{diss} (T = 85 °C) (derate 16.86 mW/°C above 85 °C)	1.09 W
Thermal Resistance (junction to lead)	59.3 °C/W
Storage Temperature	-65 to +150 °C
Operating Temperature	-40 to +85 °C



ELECTROSTATIC SENSITIVE DEVICE
 OBSERVE HANDLING PRECAUTIONS

Outline Drawing

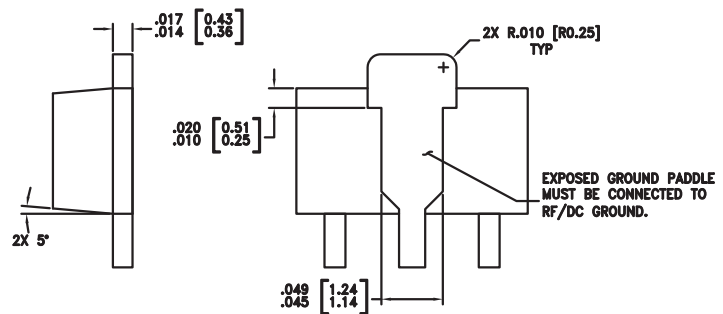
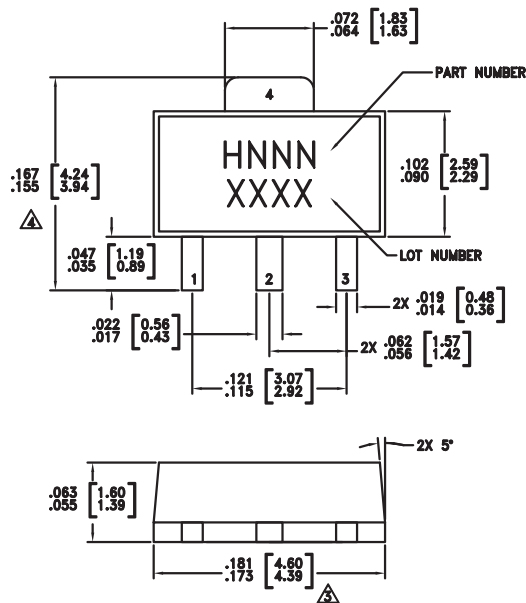

NOTES:

- LEADFRAME MATERIAL: COPPER ALLOY
- DIMENSIONS ARE IN INCHES [MILLIMETERS].
- DIMENSION DOES NOT INCLUDE MOLDFLASH OF 0.15mm PER SIDE.
- DIMENSION DOES NOT INCLUDE MOLDFLASH OF 0.25mm PER SIDE.
- ALL GROUND LEADS MUST BE SOLDERED TO PCB RF GROUND.

Package Information

Part Number	Package Body Material	Lead Finish	MSL Rating	Package Marking ^[3]
HMC475ST89	Low Stress Injection Molded Plastic	Sn/Pb Solder	MSL1 ^[1]	H475 XXXX
HMC475ST89E	RoHS-compliant Low Stress Injection Molded Plastic	100% matte Sn	MSL1 ^[2]	H475 XXXX

[1] Max peak reflow temperature of 235 °C
 [2] Max peak reflow temperature of 260 °C
 [3] 4-Digit lot number XXXX



Pin Descriptions

Pin Number	Function	Description	Interface Schematic
1	IN	This pin is DC coupled. An off chip DC blocking capacitor is required.	
3	OUT	RF output and DC Bias (Vcc) for the output stage.	
2, 4	GND	These pins and package bottom must be connected to RF/DC ground.	

Application Circuit

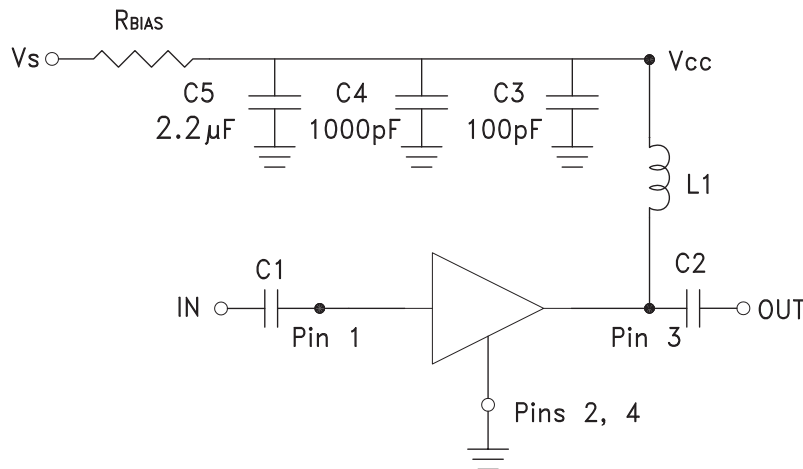

Recommended Bias Resistor Values for $I_{cc} = 110 \text{ mA}$, $R_{bias} = (V_s - V_{cc}) / I_{cc}$

Supply Voltage (Vs)	8V	9V	10V	12V
RBIAS VALUE	9.1 Ω	18 Ω	27 Ω	43 Ω
RBIAS POWER RATING	¼ W	½ W	½ W	1 W

Note:

- External blocking capacitors are required on RFIN and RFOUT.
- RBIAS provides DC bias stability over temperature.

Recommended Component Values for Key Application Frequencies

Component	Frequency (MHz)						
	50	900	1900	2200	2400	3500	4500
L1	270 nH	56 nH	18 nH	18 nH	15 nH	8.2 nH	6.8 nH
C1, C2	0.01 μF	100 pF	100 pF	100 pF	100 pF	100 pF	100 pF



Evaluation PCB

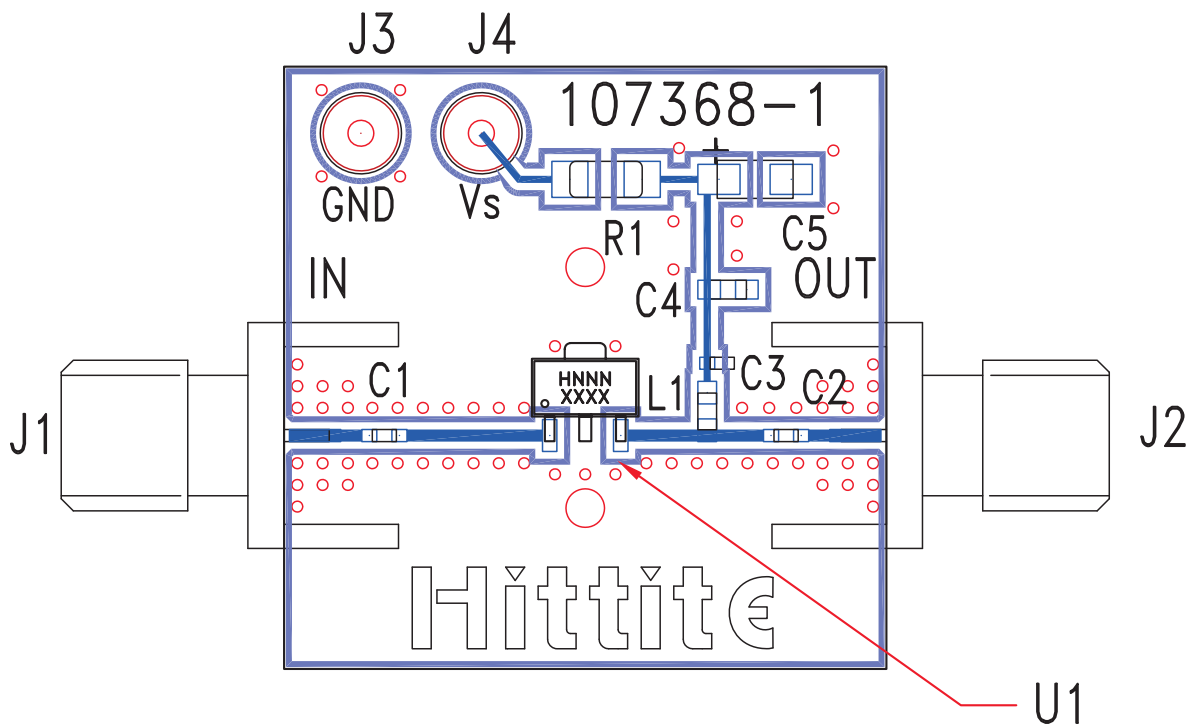

List of Materials for Evaluation PCB 116092 [1]

Item	Description
J1 - J2	PCB Mount SMA Connector
J3 - J4	DC Pin
C1, C2	Capacitor, 0402 Pkg.
C3	100 pF Capacitor, 0402 Pkg.
C4	1000 pF Capacitor, 0603 Pkg.
C5	2.2 μ F Capacitor, Tantalum
R1	Resistor, 1206 Pkg.
L1	Inductor, 0603 Pkg.
U1	HMC475ST89 / HMC475ST89E
PCB [2]	107368 Evaluation PCB

[1] Reference this number when ordering complete evaluation PCB

[2] Circuit Board Material: Rogers 4350

The circuit board used in the final application should use RF circuit design techniques. Signal lines should have 50 ohm impedance while the package ground leads and package bottom should be connected directly to the ground plane similar to that shown. A sufficient number of via holes should be used to connect the top and bottom ground planes. The evaluation board should be mounted to an appropriate heat sink. The evaluation circuit board shown is available from Hittite upon request.