



# HMC751LC4

## SMT PHEMT LOW NOISE AMPLIFIER, 17 - 27 GHz

### Typical Applications

The HMC751LC4 is ideal for:

- Point-to-Point Radios
- Point-to-Multi-Point Radios & VSAT
- Test Equipment and Sensors
- Military

### Features

- Noise Figure: 2.2 dB
- Gain: 25 dB
- OIP3: +25 dBm
- Single Supply: +4V @ 73 mA
- 50 Ohm Matched Input/Output
- RoHS Compliant 4 x 4 mm Package

### Functional Diagram

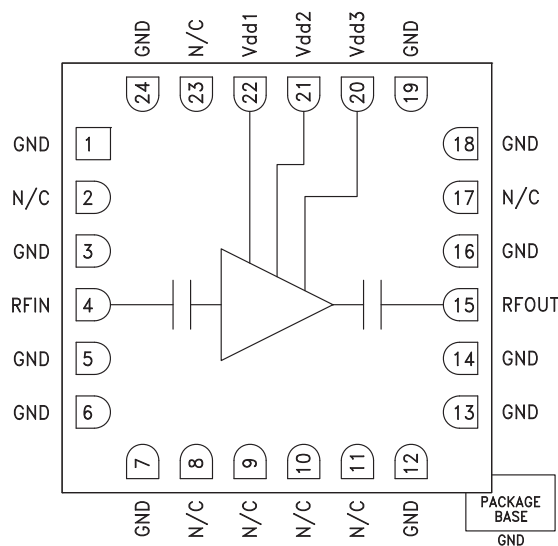

### General Description

The HMC751LC4 is a high dynamic range GaAs PHEMT MMIC Low Noise Amplifier (LNA) housed in a leadless "Pb free" RoHS compliant SMT package. The HMC751LC4 provides 25 dB of small signal gain, 2.2 dB of noise figure and output IP3 of +25 dBm. The P1dB output power of +13 dBm also enables the LNA to function as a LO driver for balanced, I/Q or image reject mixers. The HMC751LC4 allows the use of surface mount manufacturing techniques.

### Electrical Specifications, $T_A = +25^\circ C$ , Vdd 1, 2, 3 = +4V

Parameter	Min.	Typ.	Max.	Min.	Typ.	Max.	Units
Frequency Range	17 - 20			20 - 27			GHz
Gain	22	24		23	25		dB
Gain Variation Over Temperature		0.025			0.028		dB/ °C
Noise Figure		2.2	2.8		2.0	2.6	dB
Input Return Loss		17			15		dB
Output Return Loss		16			15		dB
Output Power for 1 dB Compression (P1dB)		13			13		dBm
Saturated Output Power (Psat)		15			15		dBm
Output Third Order Intercept (IP3)		25			25		dBm
Supply Current (Idd)(Vdd = +4V)	50	73	90	50	73	90	mA



## HMC751LC4

### SMT PHEMT LOW NOISE AMPLIFIER, 17 - 27 GHz

**Gain vs. Temperature**

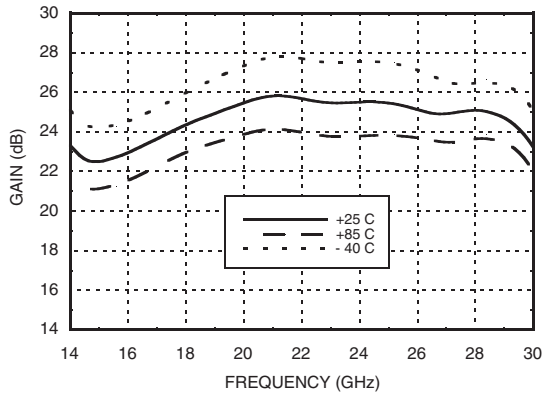

**Gain vs. Supply Voltage**

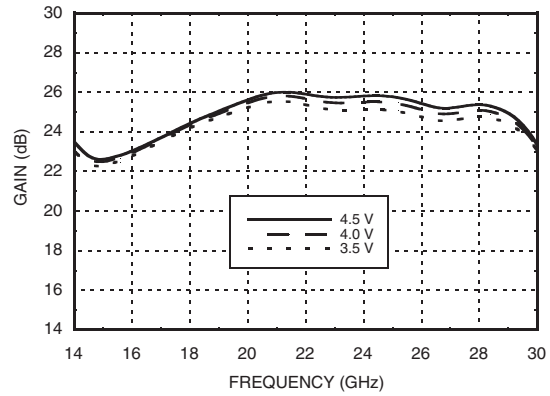

**Input Return Loss vs. Temperature**

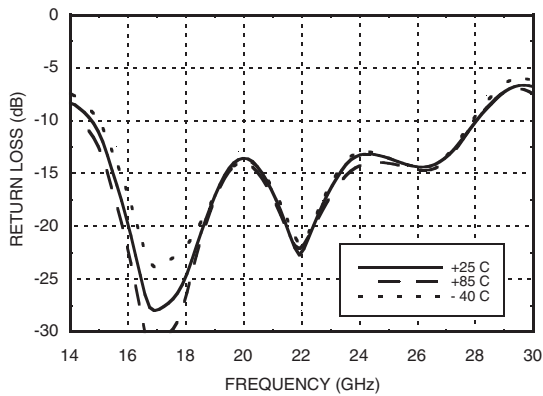

**Output Return Loss vs. Temperature**

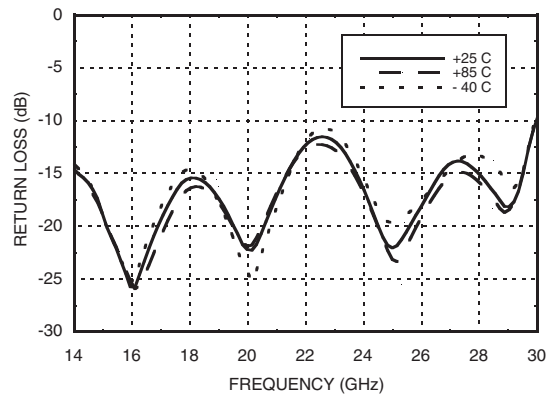

**Noise Figure vs. Temperature**

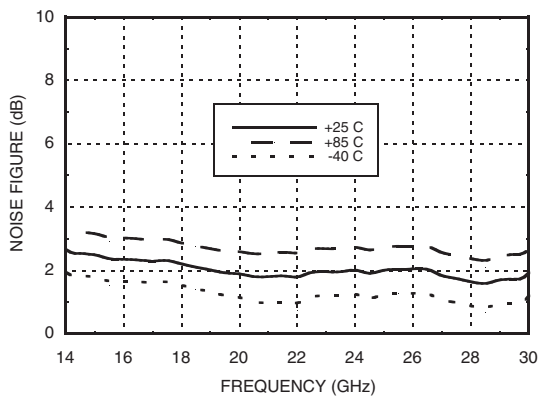

**Output IP3 vs. Temperature**

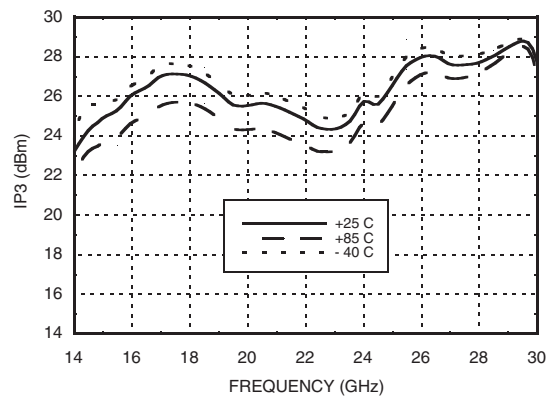



**P1dB vs. Temperature**

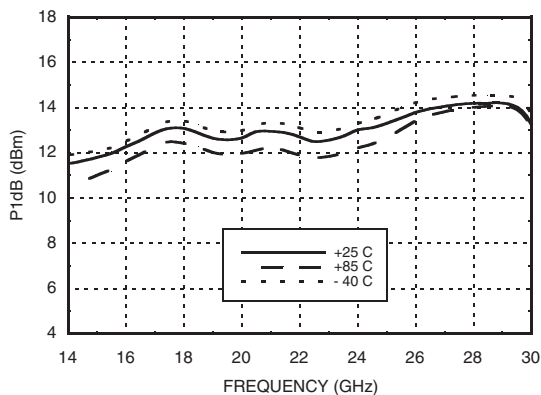

**P1dB vs. Supply Voltage**

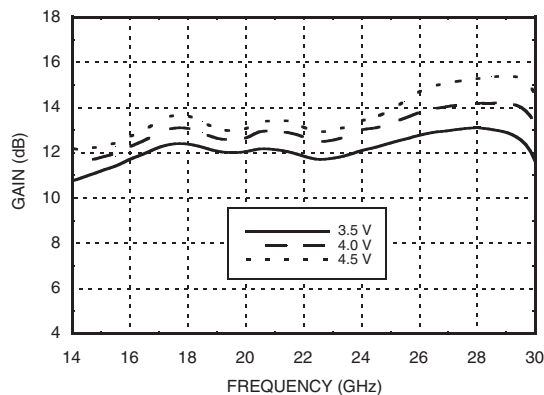

**Psat vs. Temperature**

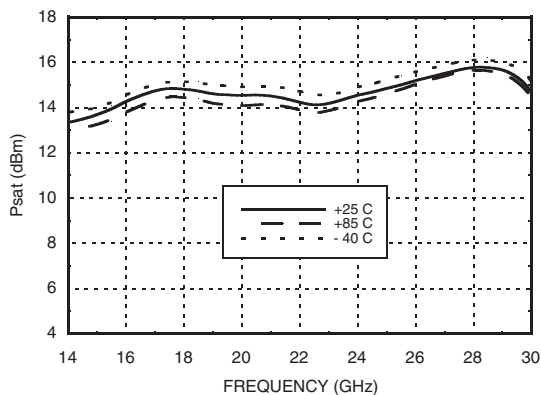

**Reverse Isolation vs. Temperature**

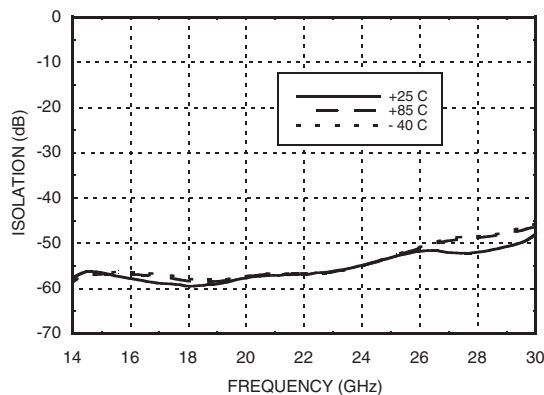

**Power Compression @ 21 GHz**

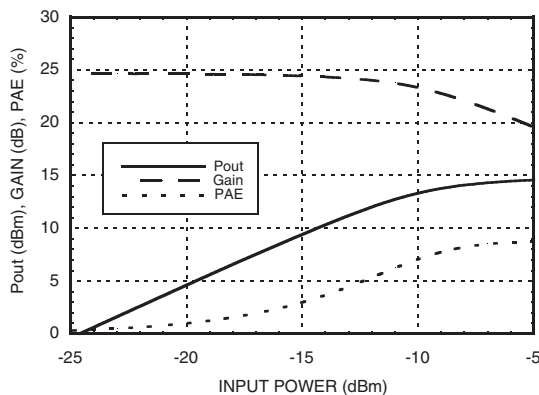



#### Absolute Maximum Ratings

Drain Bias Voltage (Vdd1, Vdd2, Vdd3)	+5.5 Vdc
RF Input Power (RFIN)(Vdd = +4 Vdc)	-5 dBm
Channel Temperature	175 °C
Continuous Pdiss (T= 85 °C) (derate 11.2 mW/°C above 85 °C)	1 W
Thermal Resistance (channel to ground paddle)	89 °C/W
Storage Temperature	-65 to +150 °C
Operating Temperature	-40 to +85 °C

#### Typical Supply Current vs. Vdd

Vdd (Vdc)	Idd (mA)
+3.5	69
+4.0	73
+4.5	77

Note: Amplifier will operate over full voltage range shown above.



ELECTROSTATIC SENSITIVE DEVICE  
OBSERVE HANDLING PRECAUTIONS

#### Outline Drawing

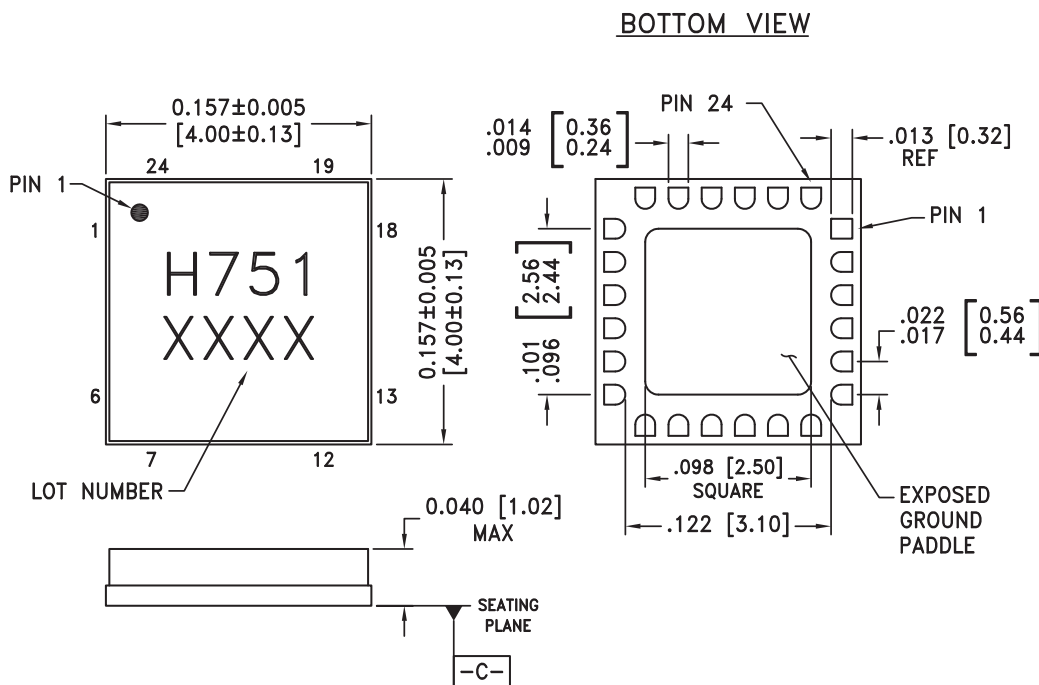

#### NOTES:

1. PACKAGE BODY MATERIAL: ALUMINA
2. LEAD AND GROUND PADDLE PLATING: 30-80 MICROINCHES GOLD OVER 50 MICROINCHES MINIMUM NICKEL
3. DIMENSIONS ARE IN INCHES [MILLIMETERS]
4. LEAD SPACING TOLERANCE IS NON-CUMULATIVE
5. PACKAGE WARP SHALL NOT EXCEED 0.05mm DATUM
6. ALL GROUND LEADS AND GROUND PADDLE MUST BE SOLDERED TO PCB RF GROUND



### SMT PHEMT LOW NOISE AMPLIFIER, 17 - 27 GHz

8

LOW NOISE AMPLIFIERS - SMT

#### Pin Descriptions

Pin Number	Function	Description	Interface Schematic
1, 3, 5 - 7, 12 - 14, 16, 18, 19, 24	GND	These pins and package bottom must be connected to RF/DC ground.	
2, 8 - 11, 17, 23	N/C	This pin may be connected to RF/DC ground. Performance will not be affected.	
4	RFIN	This pin is AC coupled and matched to 50 Ohms.	
15	RFOUT	This pin is AC coupled and matched to 50 Ohms.	
22, 21, 20	Vdd1, 2, 3	Power Supply Voltage for the amplifier. External bypass capacitors of 100 pF, 1,000 pF and 2.2 μF are required.	

#### Application Circuit

Component	Value
C1, C2, C3	100 pF
C4, C5, C6	1,000 pF
C7, C8, C9	2.2 μF

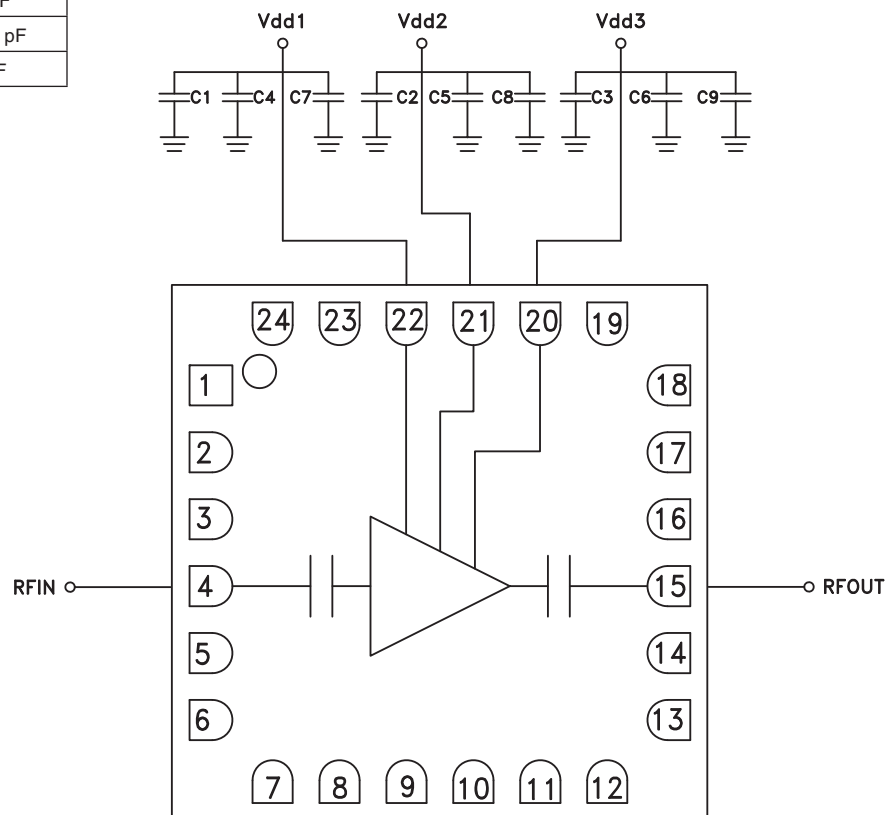

**Evaluation PCB**

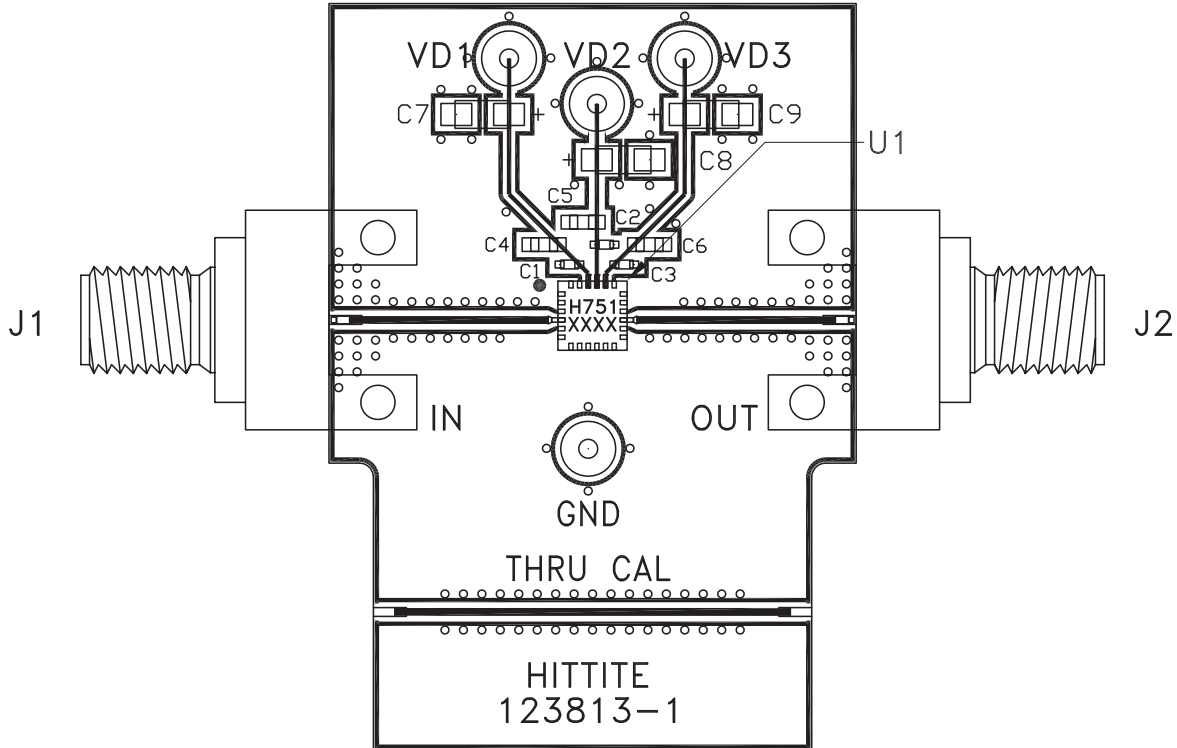

**List of Materials for Evaluation PCB 123815 [1]**

Item	Description
J1 - J2	PCB Mount K Connector
J3 - J6	DC Pin
C1 - C3	100 pF Capacitor, 0402 Pkg.
C4 - C6	1,000 pF Capacitor, 0603 Pkg.
C7 - C9	2.2 μF Capacitor, Tantalum
U1	HMC751LC4 Amplifier
PCB [2]	123813 Evaluation PCB

[1] Reference this number when ordering complete evaluation PCB

[2] Circuit Board Material: Rogers 4350 or Arlon 25FR

The circuit board used in the final application should use RF circuit design techniques. Signal lines should have 50 ohm impedance while the package ground leads and exposed paddle should be connected directly to the ground plane similar to that shown. A sufficient number of via holes should be used to connect the top and bottom ground planes. The evaluation board should be mounted to an appropriate heat sink. The evaluation circuit board shown is available from Hittite upon request.