

OKI electronic components

OPU813, OPU813R

Reflector-Type Photo Interrupter

GENERAL DESCRIPTION

The OPU813 and OPU813R are reflector-type photo interrupters that have been developed for reading 0.17mm bar codes.

FEATURES

- Aspherical lenses control a bundle of rays accurately.
- Integrated molding of the lens with the case yields good alignment accuracy and small dispersions of the characteristics.
- The Connector is integrally molded with the case and is compatible with an IL-Y type connector made by Japan Aviation Electronic Ind., Ltd.
- Assembling without an adhesive and solder achieves the high quality.
- Lens part is not directly exposed to the external environment. Therefore, paper powder scarcely deposits on the reading part.
- S/N ratio is improved by optically separating the light emitting part and receiving part with light shielding wall.

APPLICATIONS

- Bar code reader
- Paper edge sensor (Printer, Plotter)
- Detector of small electronic components such as a chip resistor, chip capacitor, etc.
- Detection of the front and back sides of small electronic components

PIN CONFIGURATION

OPU813, OPU813R

(Unit: mm)

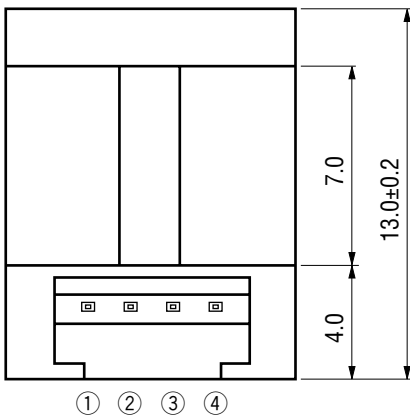
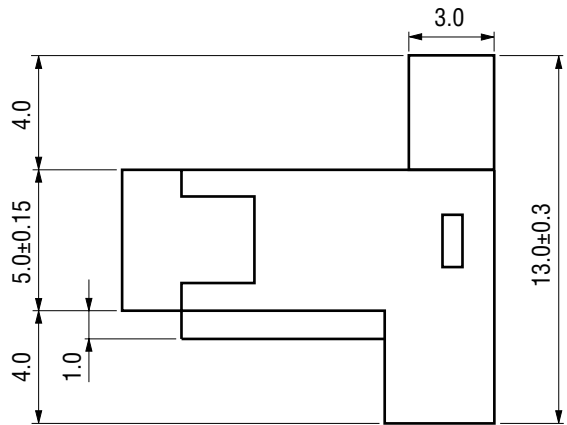
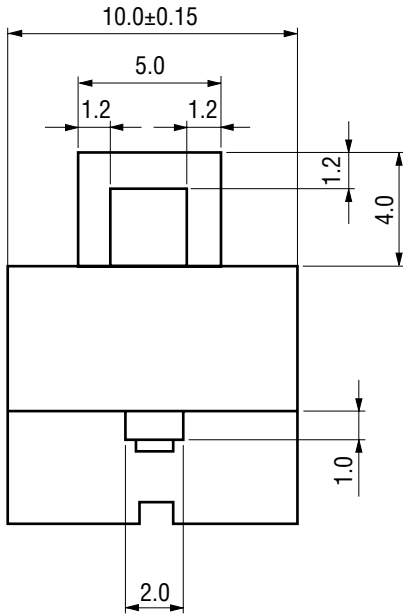

Pin Connection

- ① LED Anode
- ② LED Cathode
- ③ PTr Emitter
- ④ PTr Collector

OPTICAL LAYOUT

OPU813, OPU813R

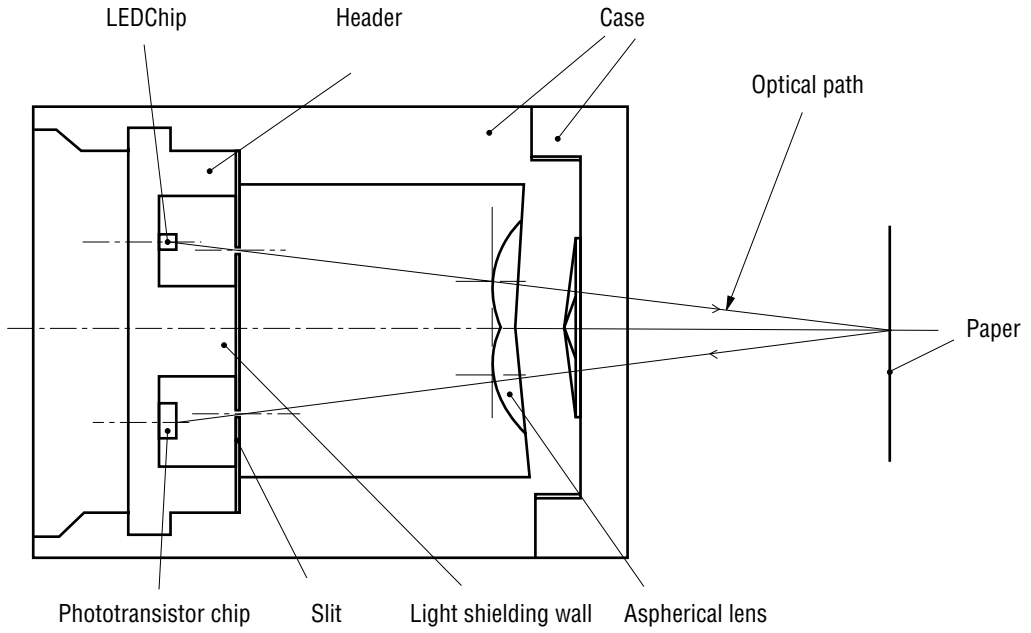

ABSOLUTE MAXIMUM RATINGS

Parameter		Symbol	Test Condition	Rating		Unit
				OPU813	OPU813R	
Input	LED Forward Current	I_F	Ta=25°C	40	30	mA
	LED Reverse Voltage	V_R		5.5	5.0	V
	Power Dissipation	P_D		60	60	mW
Output	Collector-emitter Voltage	V_{CEO}		20		V
	Emitter-collector Voltage	V_{ECO}		5		V
	Power Dissipation	P_C		40	40	mW
Operating Temperature		T_{opr}	—	0 to +65		°C
Storage Temperature		T_{stg}	—	-10 to +70		°C

ELECTRICAL CHARACTERISTICS

OPU813

(Ambient Temperature Ta=25°C, Tilt Angle=15°C)

Parameter		Symbol	Test Condition	Min.	Typ.	Max.	Unit
Input	Forward Voltage	V_F	$I_F=40\text{mA}$	—	1.4	1.8	V
	Reverse Current	I_R	$V_R=5.5\text{V}$	—	—	10	μA
	Peak-emission Wavelength	λ_P	$I_F=40\text{mA}$	—	910	—	nm
Output	Dark Current	I_D	$V_C=5\text{V}$	—	—	60	nA
Coupled	Photocurrent	I_P	$V_C=5\text{V}$	4.5	18	60	μA
	S/N Ratio	—	*1	2.5	3.6	—	—
	Maximum-sensitivity Point	ℓ		—	3.65	—	mm
	Focal Depth	$\Delta \ell$		—	0.9	—	mm

*1 Coupled characteristics measuring method.

ELECTRICAL CHARACTERISTICS (Continued)

OPU813R

(Ambient Temperature $T_a=25^{\circ}\text{C}$, Tilt Angle= 15°C)

	Parameter	Symbol	Test Condition	Min.	Typ.	Max.	Unit
Input	LED Forward Voltage	V_F	$I_F=20\text{mA}$	—	1.8	2.2	V
	LED Reverse Current	I_R	$V_R=5\text{V}$	—	—	10	μA
	Peak-emission Wavelength	λ_P	$I_F=20\text{mA}$	—	660	—	nm
Output	Dark Current	I_D	$V_C=5\text{V}$	—	—	60	nA
Coupled	Photocurrent	I_P	$V_C=5\text{V}$	1	10	30	μA
	S/N Ratio	—	*1	2.5	5.0	—	—
	Maximum-sensitivity Point	ℓ		—	3.65	—	mm
	Focal Depth	$\Delta \ell$		—	0.8	—	mm

*1 Coupled characteristics measuring method.

COUPLED CHARACTERISTICS MEASURING METHOD.

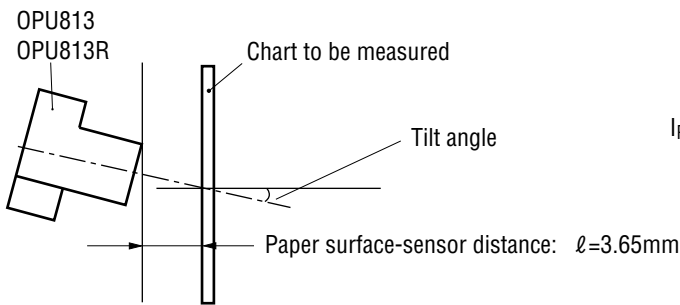

Conditions

- Facsimile chart
- 0.167mm bar codes (S/N Ratio)
- White area (Other coupled characteristics)
- OPU813 : $I_F=35\text{mA}$, $V_C=5\text{V}$, $R_L=10\text{k}\Omega$
- OPU813R : $I_F=20\text{mA}$, $V_C=5\text{V}$, $R_L=10\text{k}\Omega$

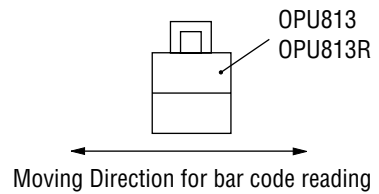
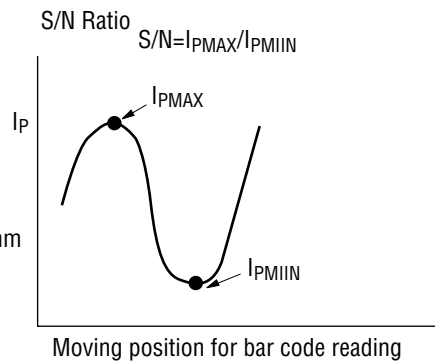

TYPICAL CHARACTERISTICS

- Input Forward Current vs. Output Photocurrent

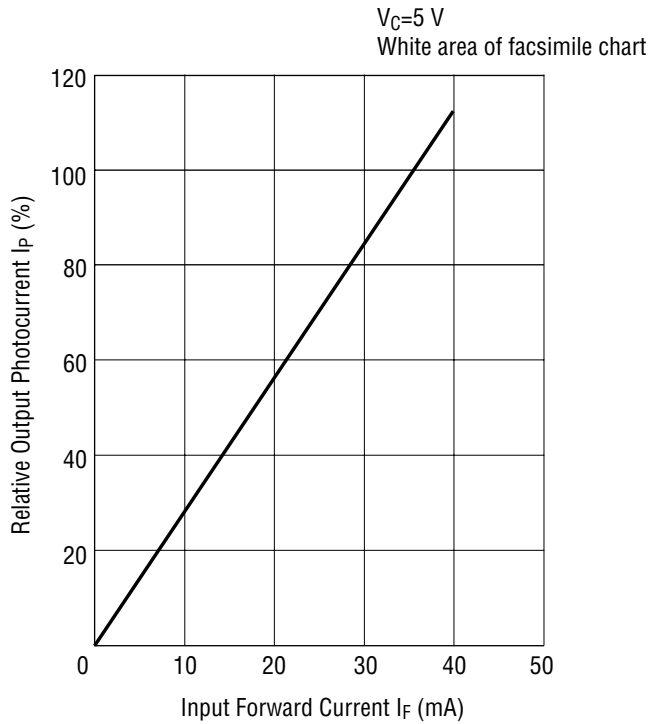

- OPU813R Input Forward Current I_F vs. Output Photocurrent

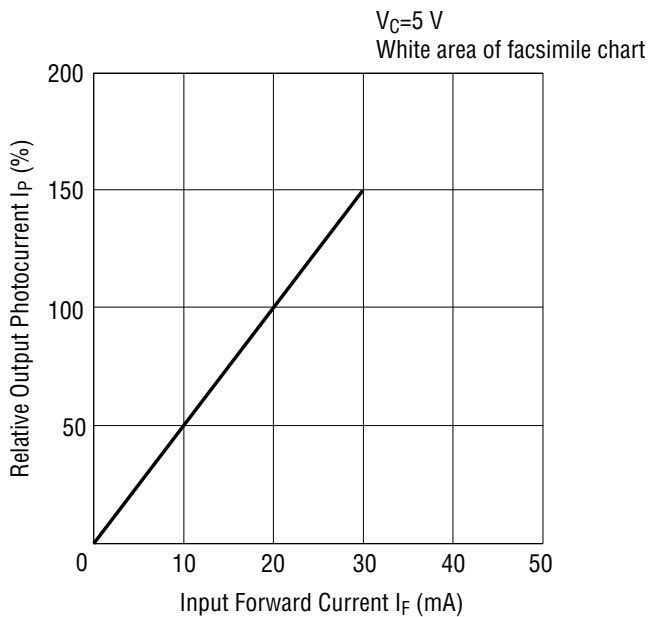

- OPU813 Output Photocurrent vs. Paper Surface-Sensor Spacing

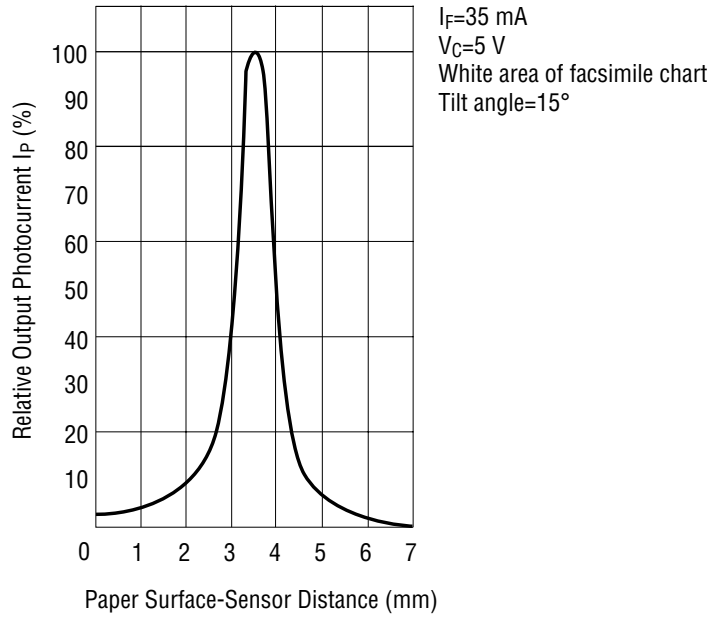

- OPU813R Output Photocurrent vs. Paper Surface-Sensor Spacing

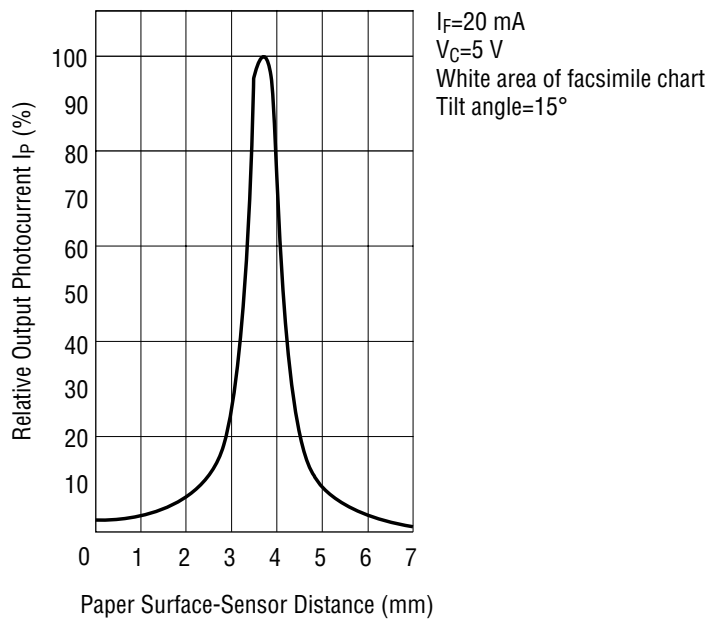

- OPU813 Output Photocurrent vs. Distance from Edge of Facsimile Chart

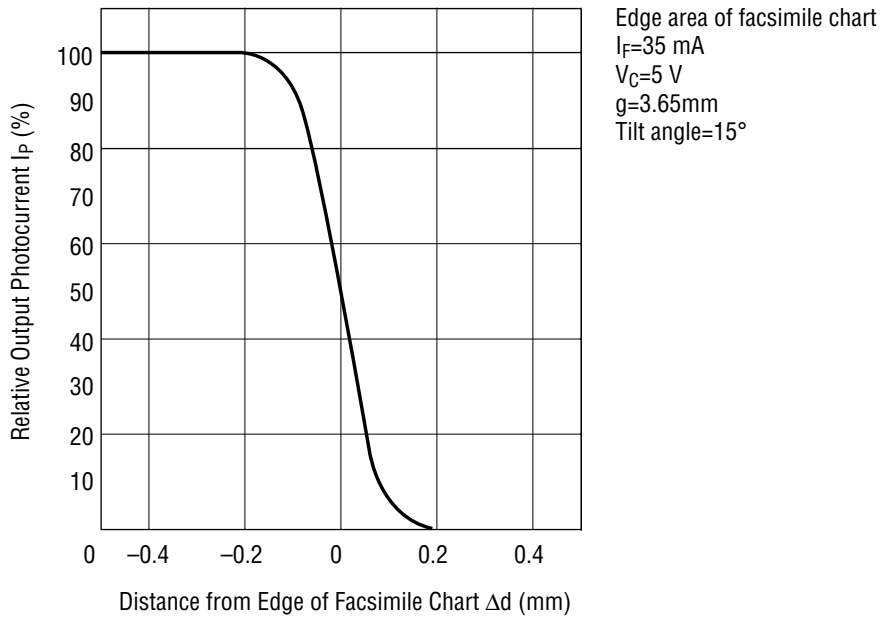

- OPU813R Output Photocurrent vs. Distance from Edge of Facsimile Chart

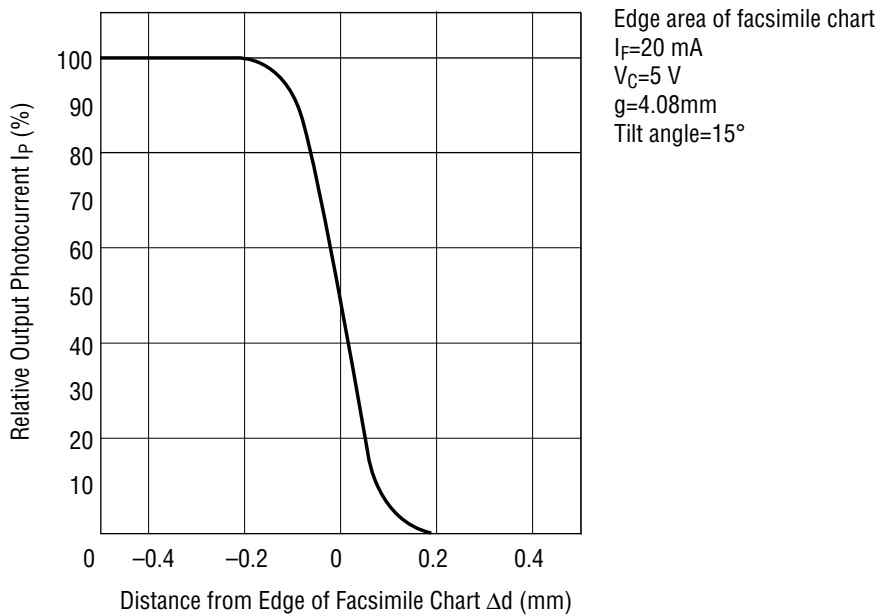

- **OPU813 Forward Voltage vs. Ambient Temperature**

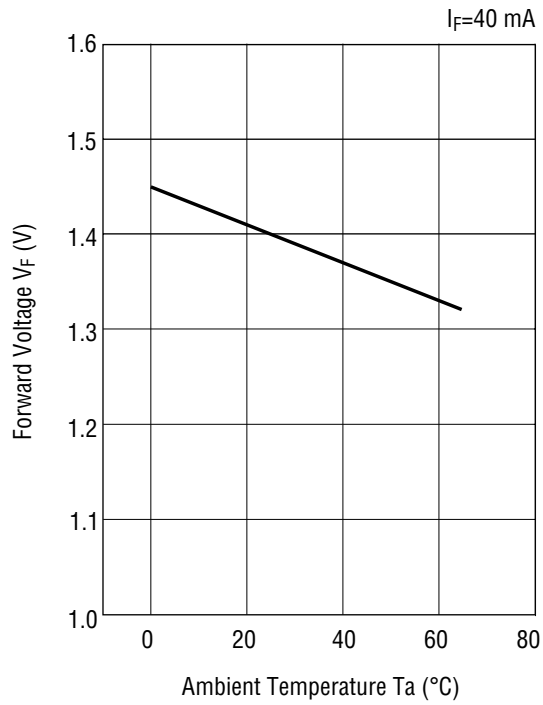

- **OPU813R Forward Voltage vs. Ambient Temperature**

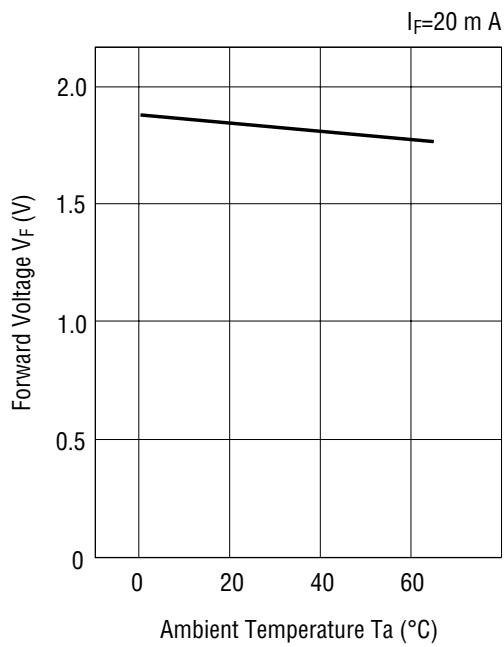

- OPU813 Output Photocurrent vs. Ambient Temperature

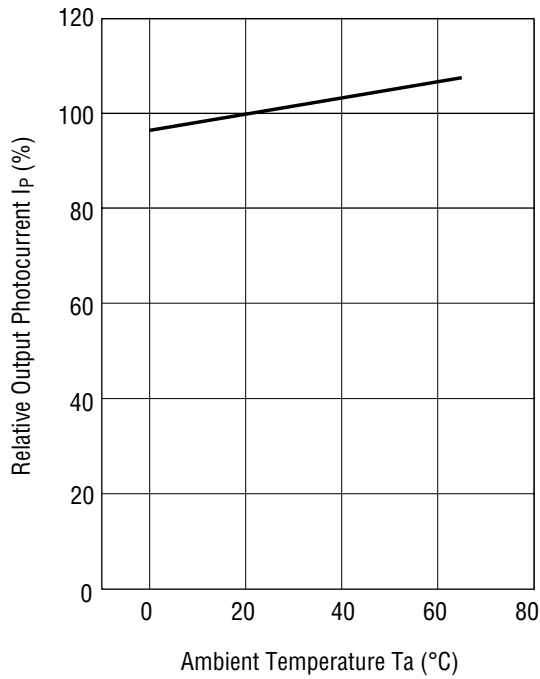

$I_F=35$ mA
 $V_C=5$ V
White area of facsimile chart

- OPU813R Output Photocurrent vs. Ambient Temperature

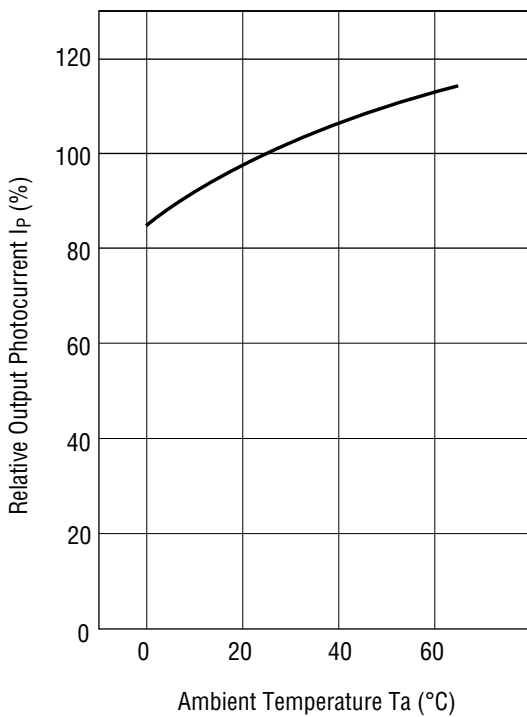

$I_F=20$ mA
 $V_C=5$ V
White area of facsimile chart

• OPU813 Maximum Pulse Forward Current Tolerance

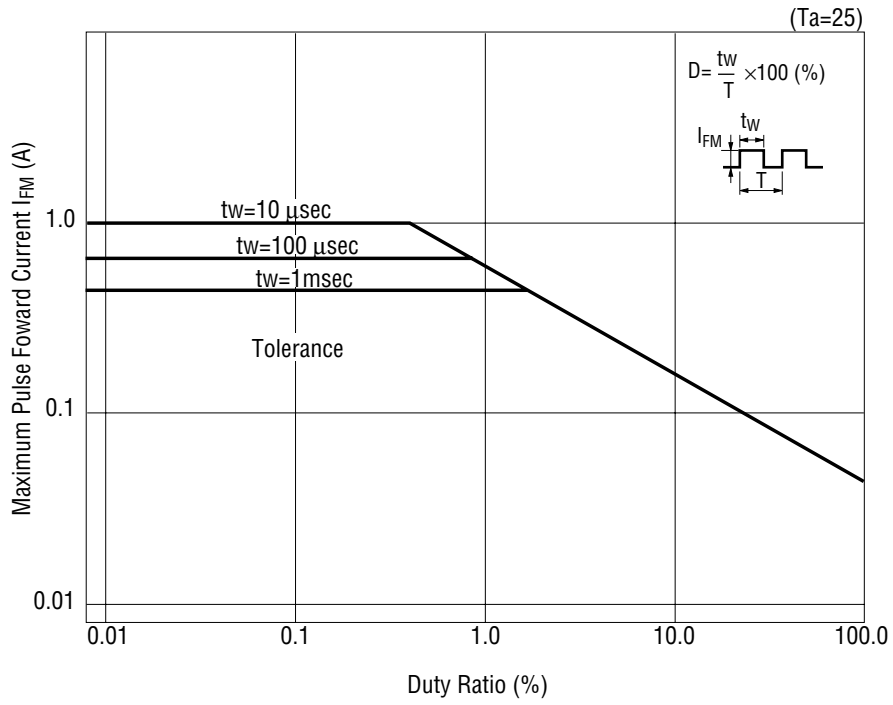

• OPU813R Maximum Pulse Forward Current Tolerance

