

TGS2600 空气污染检测用

特点:

- 5V 固定电压、低功耗
- 对香烟、烹调臭味高灵敏度
- 长寿命、低成本
- 可利用简单电路

敏感素子由集成的加热器以及在氧化铝基板上形成的金属氧化物半导体构成。当可检知的气体存在时，空气中该气体的浓度越高，传感器的电导率就越高。使用简单的电路就可以将这种电导率的变化变换为与气体浓度对应的输出信号。

TGS2600 对香烟的烟雾或烹调臭味有很高的灵敏度。这种传感器是利用相对值检知来实现更接近人类感觉的控制，即以空气清洁的时候为基准，通过传感器电阻值比空气清洁时变化了多少来检测空气的污染程度。加热器电流很小，只有 42mA，因为使用 DC5V 的固定电压，所以是使用非常方便的传感器，广泛用于空气清新机等控制中。

下图是典型的灵敏度特性，全部是在标准试验条件下得出的结果。（请看背面）

纵轴以传感器电阻比 $R_s/R_s(\text{Air})$ 表示， R_s 、 $R_s(\text{Air})$ 的定义如下：

R_s = 各种浓度气体中的传感器电阻值
 $R_s(\text{Air})$ = 清洁大气中的传感器电阻值

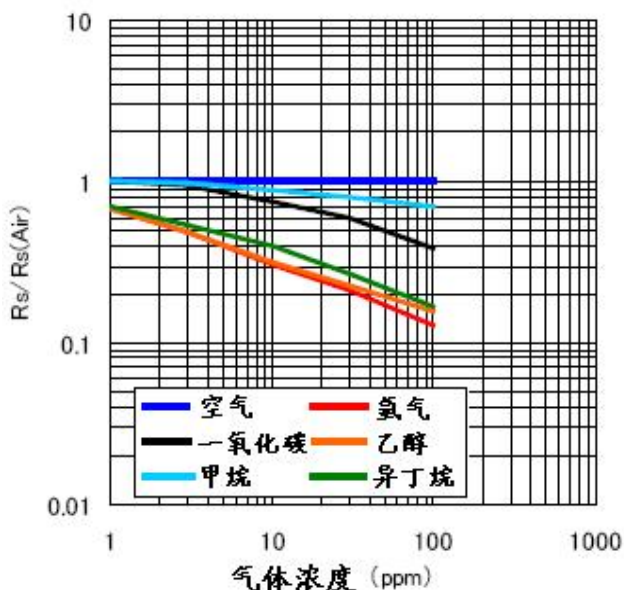
灵敏度特性:应用:

- 空气清新机控制
- 换气扇控制
- 室内空气监视器



下图是典型的香烟烟雾灵敏度特性。

香烟的根数是约 10 平米的房间吸烟情况下的数值。这里的纵轴也用传感器电阻比 $R_s/R_s(\text{Air})$ 来表示，这里的 R_s 、 $R_s(\text{Air})$ 定义如下：

R_s = 香烟的烟雾存在时的传感器电阻值
 $R_s(\text{Air})$ = 清洁大气中的传感器电阻值

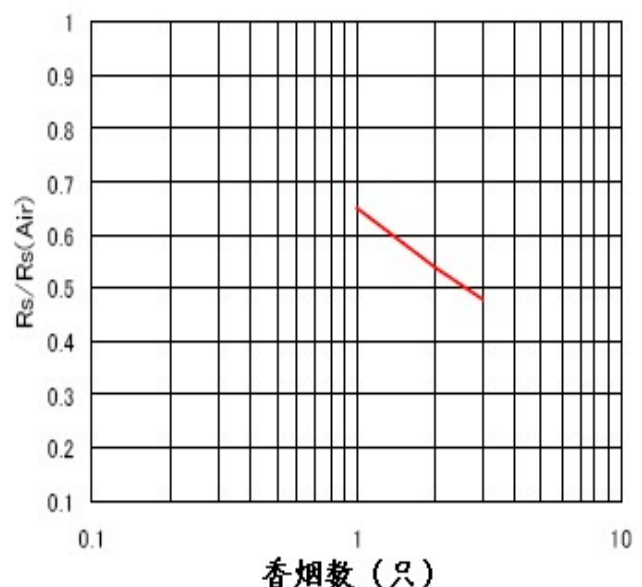
香烟的灵敏度特性:

基本测试回路:

此传感器需要施加 2 个电压: 加热器电压 (V_H) 和回路电压 (V_C)。这个 V_H 用于维持敏感素子处于与对象气体相适应的特定温度而施加在集成的加热器上。 V_C 则是用于测定与传感器串联的负载电阻 (R_L) 上的两端电压 (V_{OUT})。

这种传感器具有极性, 所以 V_C 需用直流电源。只要能满足传感器的电性要求, V_C 和 V_H 可以共用同一个电源电路。为了将判定值水平最佳化, 并使敏感素子的功耗 (P_S) 低于 15mW 的限度值, 需要选择 R_L 的值。

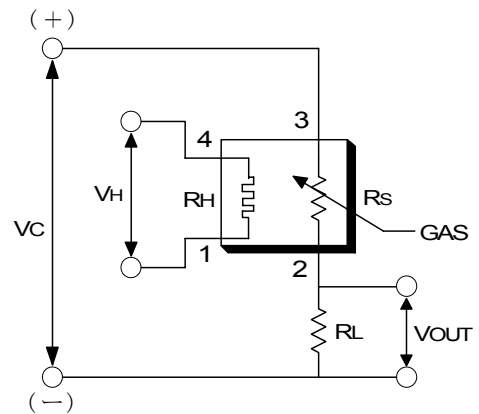

规格:

型号		TGS2600	
素子类型		26 系列	
标准封装		金属	
对象气体		氢气、酒精等	
检测范围		1 ~ 10 ppm	
标准回路	加热器电压	VH	5.0 ± 0.2V DC/AC
	回路电压	VC	5.0 ± 0.2V DC
	负载电阻	RL	可变
			$P_S \leq 15mW$
标准试验	加热器电阻	RH	83 Ω (室温)
	加热器电流	IH	42mA
	加热器功耗	PH	210mW
			VH = 5.0V DC/AC
	传感器电阻	RS	10 ~ 90 K Ω (空气中)
	灵敏度 (RS 的变化率)		0.3 ~ 0.6
			$\frac{RS(H2: 10ppm)}{RS(Air)}$
标准试验	试验气体条件	20 ± 2°C, 65 ± 5%RH	
	回路条件	VC = 5.0 ± 0.2V DC VH = 5.0 ± 0.2V DC/AC	
	试验前预热时间	36 小时以上	

结构及尺寸:

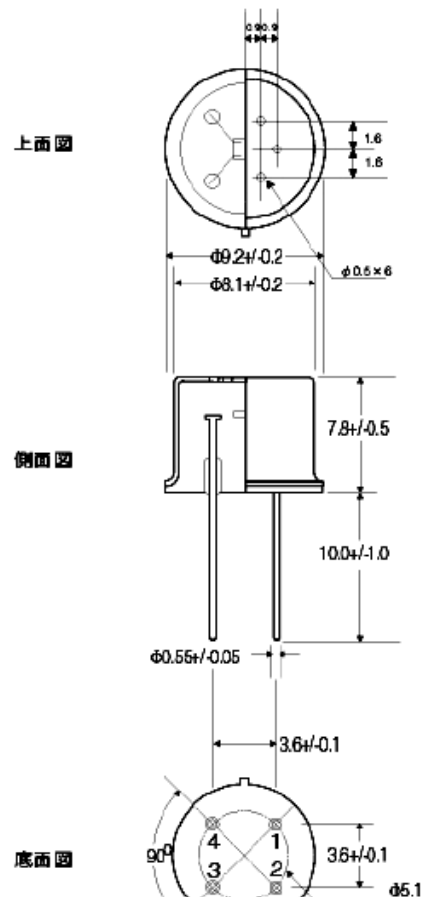

- 1: 加热器电极
- 2: 传感器电极 (-)
- 3: 传感器电极 (+)
- 4: 加热器电极

功耗 (P_S) 值可用下式计算:

$$P_S = \frac{(V_C - V_{OUT})^2}{R_S}$$

传感器电阻 (R_S), 可根据 V_{OUT} 测定值, 用下式计算:

$$R_S = \frac{V_C \times R_L}{V_{OUT}} - R_L$$

为提高性能, 本规格书将不事先预告而变更。

▶TGS 传感器通用资料下载				
半导体气体传感器 (品牌: 日本 Figaro)				
型号	测量气体	量程(ppm)	灵敏度(电阻比)	典型应用
TGS2600-B00	香烟气, 氢气, 酒精, 甲烷, CO	1~30	0.3~0.6	空气清新机, 换气空调
TGS2602-B00	甲苯, 乙醇, H ₂ S, NH ₃ , H ₂ 等	1~30	0.15~0.5	空气清新监测仪
TGS2100	油烟气, 氢气, 燃气	1~30	0.2~0.6	抽油烟机, 空气清新机
TGS2104	汽油机尾气(H ₂ , CO, HC)	10~1000	0.3~0.6	汽车尾气检测
TGS2201	汽油/柴油机尾气(NO, NO ₂)	10~100/0.1~10	0.35/2.5	
TGS813	易燃气体(甲、丙、丁烷)	500~10,000	0.60±0.05	家庭燃气泄漏报警器
TGS816	易燃气体(甲、丙、丁烷)	500~10,000	0.60±0.05	工业用易燃, 易爆
TGS2610-B00	易燃气体(丁烷)<圆型, 酒精过滤>	500~10,000	0.53±0.05	民用/工业用易燃, 易爆
TGS2610-J00	易燃气体(丁烷) <方型>	500~10,000	0.53±0.05	民用/工业用易燃, 易爆
TGS2611-B00	天然气(甲烷)<圆型, 酒精过滤>	500~10,000	0.60±0.06	气体探测气, 报警器
TGS2611-C00	天然气(甲烷)<圆型>	500~10,001	0.60±0.06	气体探测气, 报警器
TGS821	氢气	30~1000	0.6~1.20	
TGS2442	一氧化碳	30~1,000	0.23~0.49	室内气体报警器
TGS2620-A00	酒精(金属外壳)	50~5,000	0.35±0.1	酒精探测器
TGS2620-C00	酒精(不锈钢外壳)	50~5,000	0.35±0.1	酒精探测器
TGS822	酒精	50~5,000	0.40±0.1	醉酒度测试仪
TGS825	硫化氢	5~100	0.3~0.6	有毒有害气体报警器
TGS826	氨气	30~300	0.4~0.70	电冰箱气

				体探测
TGS830	R-113,R-22,R-11,R-12	100~3,000	0.30±0.10	卤素检漏仪,
TGS831	R-21,R-22	100~3,000	0.40±0.15	氟利昂检测器
TGS832	R-134a	100~3,000	0.50~0.65	
KE-25	氧气 (电化式, 5 年寿命)	0~100%	±1%	氧气分析仪
KE-50	氧气 (电化式, 10 年寿命)	0~100%	±2%	氧气分析仪
KE-25F3	氧气 (电化式, 5 年寿命)	0~100%	±1%	氧气分析仪
TGS4160	二氧化碳 (固态, 10 年寿命)	350~30000ppm	±20% @ 1000ppm	蔬菜大棚, 孵化设备
TGS4161	二氧化碳 (固态, 10 年寿命)	350~5000ppm	±20% @ 1000ppm	蔬菜大棚, 孵化设备
AM-4	二氧化碳模块, 用于检测 TGS4160, 重新标定 TGS4160			CO2 检测
AM-4-4161	二氧化碳模块, 用于检测 TGS4161, 重新标定 TGS4161		(小尺寸,低功耗)	CO2 检测
COM2442	一氧化碳检测模块, 设置 30、70、150ppm 三档报警			
LPM2610	TGS2610 检测模块, 可以用于居民区液化石油气泄露报警	500~10000ppm		
NGM2611	TGS2611 检测模块, 可以用于居民区天然气泄露报警	500~10000ppm		
AMS2600	TGS2600 检测模块, 可以用于空调、空气清新机等家电	1~30ppm		
AMS2100	TGS2100 检测模块, 可以用于智能抽油烟机厨房电器			
AM-1-2600	TGS2600 检测模块, 检测低浓度的空气污染物 (带微处理器)			

日本 FIGARO

TGS 8 系列传感器 8-Series TGS Sensor

产品/型号	产品样图	用途	主要检测对象	检测范围	使用电压	消耗功率	特徵	详细
TGS813		可燃气体检测	甲烷、丙烷 异丁烷	500~10,000ppm	DC5V	835mW	可燃气体泄漏 报警器应用 30 年业绩	

TGS822		有机溶剂检测	酒精有机溶剂	50~5,000ppm	DC5V	660mW	有机溶剂、 酒精检测报警器 应用 20 年业绩
TGS822TF		煤制气检测	煤制气中氢气	200~5,000ppm	DC5V	660mW	煤制气泄漏报警器 应用 10 年业绩
TGS203S		不完全燃烧 气体检测	一氧化碳	50~1,000ppm	H/L 驱动	295 / 33mW (ave. 138mW)	防一氧化碳中毒 报警器应用 20 年业绩

TGS2000 系列气体传感器 TGS2000-Series Gas Sensor

产品/型号	产品样图	用途	主要检测对象	检测范围	使用电压	消耗功率	特徵	详细
TGS2600		空气质量控制	香烟酒精	1~10ppm	DC5V	210mW	空气清新机应用业绩 空气质量控制器	
TGS2602		空气质量控制	酒精氨气 VOC	1~10ppm	DC5V	280mW	空气清新机应用业绩 空气质量控制器	
TGS2610		可燃气体检测	丙烷异丁烷	500~10,000ppm	DC5V	280mW	石油液化气泄漏报警器应用业绩低功耗	
TGS2611		可燃气体检测	甲烷天然气	500~10,000ppm	DC5V	280mW	天然气泄漏报警器应用业绩低功耗	
TGS2620		有机溶剂检测	酒精有机溶剂	50~5,000ppm	DC5V	210mW	有机溶剂检测方面 业绩低功耗	
TGS2442		毒性气体检测	一氧化碳	30~1,000ppm	DC5V 脉冲 驱动	14mW(ave.)	一氧化碳报警器应用业绩低功耗平均 约 14mW	









产品型号 产品样图 用途 主要检测气体 检测浓度范围 工作电压 功率 详细



TGS203S		毒性气体检测	<ul style="list-style-type: none"> • 一氧化碳 	50~1000ppm	H/L 驱动	295/33mW	详细
TGS813		可燃性气体	<ul style="list-style-type: none"> • 甲烷 • 丙烷 • 丁烷 	500~10000ppm	DC5V	835mW	详细
TGS2610		可燃性气体	<ul style="list-style-type: none"> • 丙烷 • 丁烷 	500~10000ppm	DC5V	280mW	详细
TGS2611		可燃性气体	<ul style="list-style-type: none"> • 甲烷 	500~10000ppm	DC5V	280mW	详细
TGS2620		溶剂蒸气	<ul style="list-style-type: none"> • 酒精 • 有机溶剂 	50~5000ppm	DC5V	280mW	详细
TGS822		溶剂蒸气	<ul style="list-style-type: none"> • 酒精 • 有机溶剂 	50~5000ppm	DC5V	660mW	详细
TGS822TF		可燃性气体	<ul style="list-style-type: none"> • 人工煤制气中 • 氢气 	200~5000ppm	DC5V	660mW	详细
TGS2600		空气质量控制	<ul style="list-style-type: none"> • 氢气 • 酒精 	1~10ppm	DC5V	210mW	详细
TGS2602		空气质量控制	<ul style="list-style-type: none"> • 酒精 • 氨气 • 有机溶剂 • 挥发 	1~10ppm	DC5V	280mW	详细
<ul style="list-style-type: none"> • TGS821 • TGS825 • TGS826 • TGS830 • TGS2442 • TGS3870 • TGS4160 	由【日本费加罗技研株式会社】生产		<ul style="list-style-type: none"> • 氢气 • 硫化氢 • 氨气 胺 • 氟利昂 有机氯气 • 一氧化碳 • 甲烷 一氧化碳(复合型) 				详细

- TGS4161
- TGS6810
- TGS6812
- TGS5042
- 二氧化碳
- 二氧化碳
- 可燃气体
- 可燃气体
- 一氧化碳

Select by application

>>Domestic safety







Model	Target gas	Typical detection range	Ps	Description	Data sheet
TGS2442	Carbon monoxide	30 - 1,000ppm	14mW	Compact size Low sensitivity to alcohol vapor For residential CO detectors	
TGS2610-D00	LP gas	500 - 10,000ppm	280mW	High selectivity to LP gas Good durability For residential gas alarms	
TGS2610-C00	LP gas	500 - 10,000ppm	280mW	Quick gas response For leak checkers	
TGS2611-E00	Methane	500 - 10,000ppm	280mW	High selectivity to methane gas Good durability For residential gas alarms	
TGS2611-C00	Methane	500 - 10,000ppm	280mW	Quick gas response For leak checkers	
TGS2612	Methane ,LP gas	500 - 10,000ppm	280mW	Stable relative sensitivity between CH4 & LP gas Good durability For residential gas alarms	
TGS3870	Methane & CO	500 - 12,500ppm 50 - 1,000ppm	38mW	Dual gas detection with one sensor For residential gas detectors	
TGS5042	Carbon monoxide	0 - 1,000ppm	No power required	Electrochemical type Battery operable Long life	
TGS6810	LP gas ,Methane	0 - 100%LEL	525mW	Catalytic type Wide detection range Linear output For residential gas alarms	

LPM2610	LP gas	500 - 10,000ppm	280mW	Precalibrated module with TGS2610 and temperature compensation circuit For residential gas detectors	
NGM2611	Methane	500 - 10,000ppm	280mW	Precalibrated module with TGS2611 and temperature compensation circuit For residential gas detectors	

Select by application

Application example>>

>>Air quality control







Model	Target gas	Typical detection range	Ps	Description	Data sheet
TGS2600	General air contaminants	1 - 30ppm	210mW	High sensitivity to air contaminants For indoor air quality control and automatic control in cooker hoods	
TGS2602	General air contaminants	1 - 30ppm	280mW	High sensitivity to VOCs and odorous gases For indoor air quality control Wide detection range Good durability	
TGS4160	Carbon dioxide	350 - 50,000ppm	1.25W	For indoor ventilation control and CO2 monitoring in factories, agriculture and automobiles Low power Compact size	
TGS4161	Carbon dioxide	350 - 10,000ppm	250mW	For indoor ventilation control in residences and high occupancy buildings	
AMS2600	General air contaminants	1 - 30ppm	210mW	Precalibrated module with TGS2600 and suitable load resistor For indoor air quality control	
CDM4160	Carbon dioxide	400-45,000ppm	1.3W	Precalibrated module Maintenance free For indoor ventilation control	
CDM4161	Carbon dioxide	400-9,000ppm	300mW	Precalibrated module Maintenance free For indoor ventilation control	

Select by application

Application example>>

>>Automotive





Model	Target gas	Typical	Ps	Description	Data
-------	------------	---------	----	-------------	------

		detection range			sheet
TGS2201	Gasoline & diesel exhaust	10 - 1,000ppm 0.1 - 10ppm	502mW	Dual gas detection with one sensor For automobile ventilation control High sensitivity to air contaminants	--
TGS2600	General air contaminants	1 - 30ppm	210mW	For indoor air quality control and automatic control in cooker hoods High sensitivity to VOCs and odorous	
TGS2602	General air contaminants	1 - 30ppm	280mW	gases For indoor air quality control High selectivity to LP gas	
TGS2610-D00	LP gas	500 - 10,000ppm	280mW	Good durability For residential gas alarms	
TGS2610-C00	LP gas	500 - 10,000ppm	280mW	Quick gas response For leak checkers	
AMS2600	General air contaminants	1 - 30ppm	210mW	Precalibrated module with TGS2600 and suitable load resistor For indoor air quality control	
LPM2610	LP gas	500 - 10,000ppm	280mW	Precalibrated module with TGS2610 and temperature compensation circuit For residential gas detectors	

Select by application

Application example>>

>>Appliance control







Model	Target gas	Typical detection range	Ps	Description	Data sheet
TGS2180	Water vapor	1 - 150g/m3	830mW	High selectivity to water vapor For automatic cooking control in microwave ovens	
TGS2600	General air contaminants	1 - 30ppm	210mW	High sensitivity to air contaminants For indoor air quality control and automatic control in cooker hoods	
TGS2602	General air contaminants	1 - 30ppm	280mW	High sensitivity to VOCs and odorous gases For indoor air quality control	
AMS2600	General air contaminants	1 - 30ppm	210mW	Precalibrated module with TGS2600 and suitable load resistor For indoor air quality control	

Select by application

Application example>>

>>Industrial safety

Model	Target gas	Typical detection range	Ps	Description	Data sheet
TGS821	Hydrogen	30 - 1,000ppm	660mW	High sensitivity and selectivity to hydrogen Ceramic base resistant to severe environments For hydrogen detectors	
TGS825	Hydrogen sulfide	5 - 100ppm	660mW	Ceramic base resistant to severe environments For hydrogen sulfide detectors	
TGS826	Ammonia	30 - 300ppm	833mW	Ceramic base resistant to severe environments For leak detection from refrigerators	
TGS832	Halocarbon gas	100 - 3,000ppm	835mW	For leak detection from refrigerators and air conditioners Ceramic base resistant to severe environments For halocarbon detectors	
TGS2442	Carbon monoxide	30 - 1,000ppm	14mW	Compact size Low sensitivity to alcohol vapor For residential CO detectors	
TGS2444	Ammonia	10 - 100ppm	56mW	High selectivity to ammonia Low power consumption For ventilation control in agricultural & poultry industries	
TGS2610-D00	LP gas	500 - 10,000ppm	280mW	High selectivity to LP gas Good durability For residential gas alarms	
TGS2610-C00	LP gas	500 - 10,000ppm	280mW	Quick gas response For leak checkers	
TGS2611-E00	Methane	500 - 10,000ppm	280mW	High selectivity to methane gas Good durability For residential gas alarms	
TGS2611-C00	Methane	500 - 10,000ppm	280mW	Quick gas response For leak checkers	
TGS2620	Alcohol ,Solvent vapors	50 - 5,000ppm	210mW	Compact size For breath alcohol testers and solvent detectors	
TGS3870	Methane & CO	500 - 12,500ppm 50 - 1,000ppm	38mW	Dual gas detection with one sensor For residential gas detectors	

TGS6812	Hydrogen ,Methane ,LP gas	0 - 100%LEL	525mW	Catalytic type Wide detection range Linear output For hydrogen and combustible gas leak detectors for fuel cells	
FCM6812	Hydrogen ,Methane ,LP gas	0 - 35%LEL	1.0W	Precalibrated module Maintenance free For gas leak detection in fuel cell systems	
LPM2610	LP gas	500 - 10,000ppm	280mW	Precalibrated module with TGS2610 and temperature compensation circuit For residential gas detectors	
NGM2611	Methane	500 - 10,000ppm	280mW	Precalibrated module with TGS2611 and temperature compensation circuit For residential gas detectors	
KE-25	Oxygen	0 - 100%	No power required	Galvanic cell type No CO2 influence Long life High accuracy	
KE-50	Oxygen	0 - 100%	No power required	Galvanic cell type No CO2 influence Long life	
SK-25	Oxygen	0 - 30%	No power required	Good linearity No CO2 influence Compact	

Select by application













Application example>>

>>Personal safety & health

Model	Target gas	Typical detection range	Ps	Description	Data sheet
TGS2620	Alcohol ,Solvent vapors	50 - 5,000ppm	210mW	Compact size For breath alcohol testers and solvent detectors	

Related products

Model	Applied sensor model	Description	Data sheet
AM-1-2600	TGS2600	Evaluation board for indoor air quality control	

AM-1-2602	TGS2602	Evaluation board for indoor air quality control	
CDM4160	TGS4160	Evaluation board for CO2 monitoring	
CDM4161	TGS4161	Evaluation board for CO2 monitoring	
COM2442	TGS2442	Evaluation board for CO detection	
FCM6812	TGS6812	Evaluation board for combustible gas detection	
SRD-1	TGS8xx	Test unit for TGS8xx series gas sensors	
FIC 00460	TGS2442	Microprocessor for CO detection	
SR-4	TGS8xx	Durable sensor socket for TGS8xx series gas sensors	
SR-5	TGS8xx	Standard sensor socket for TGS8xx series gas sensors	
SR-6	TGS26xx, TGS24xx	Standard sensor socket for TGS24xx and TGS26xx series gas sensors	
SR-8	TGS3870	Standard sensor socket for TGS38xx series gas sensors	
SR-3	TGS8xx	Test chamber for TGS8xx series gas sensors	

SUNSTAR商斯达实业集团是集研发、生产、工程、销售、代理经销、技术咨询、信息服务等为一体的高科技企业，是专业高科技电子产品生产厂家，是具有10多年历史的专业电子元器件供应商，是中国最早和最大的仓储式连锁规模经营大型综合电子零部件代理分销商之一，是一家专业代理和分销世界各大品牌IC芯片和电子元器件的连锁经营综合性国际公司。在香港、北京、深圳、上海、西安、成都等全国主要电子市场设有直属分公司和产品展示展销窗口门市部专卖店及代理分销商，已在全国范围内建成强大统一的供货和代理分销网络。我们专业代理经销、开发生产电子元器件、集成电路、传感器、微波光电元器件、工控机/DOC/DOM电子盘、专用电路、单片机开发、MCU/DSP/ARM/FPGA软件硬件、二极管、三极管、模块等，是您可靠的一站式现货配套供应商、方案提供商、部件功能模块开发配套商。专业以现代信息产业（计算机、通讯及传感器）三大支柱之一的传感器为主营业务，专业经营各类传感器的代理、销售生产、网络信息、科技图书资料及配套产品设计、工程开发。我们的专业网站——中国传感器科技信息网（全球传感器数据库）www.SENSOR-IC.COM 服务于全球高科技生产商及贸易商，为企业科技产品开发提供技术交流平台。欢迎各厂商互通有无、交换信息、交换链接、发布寻求代理信息。欢迎国外高科技传感器、变送器、执行器、自动控制产品厂商介绍产品到中国，共同开拓市场。本网站是关于各种传感器-变送器-仪器仪表及工业自动化大型专业网站，深入到工业控制、系统工程计 测量、自动化、安防报警、消费电子等众多领域，把最新的传感器-变送器-仪器仪表买卖信息，最新技术供求，最新采购商，行业动态，发展方向，最新的技术应用和市场资讯及时的传递给广大科技开发、科学研究、产品设计人员。本网站已成功为石油、化工、电力、医药、生物、航空、航天、国防、能源、冶金、电子、工业、农业、交通、汽车、矿山、煤炭、纺织、信息、通信、IT、安防、环保、印刷、科研、气象、仪器仪表等领域从事科学研究、产品设计、开发、生产制造的科技人员、管理人员、和采购人员提供满意服务。我公司专业生产、代理、经销、销售各种传感器、变送器、敏感元器件、开关、执行器、仪器仪表、自动化控制系统：专门从事设计、生产、销售各种传感器、变送器、各种测控仪表、热工仪表、现场控制器、计算机控制系统、数据采集系统、各类环境监控系统、专用控制系统应用软件以及嵌入式系统开发及应用等工作。如热敏电阻、压敏电阻、温度传感器、温度变送器、湿度传感器、湿度变送器、气体传感器、气体变送器、压力传感器、压力变送、称重传感器、物（液）位传感器、物（液）位变送器、流量传感器、流量变送器、电流（压）传感器、溶氧传感器、霍尔传感器、图像传感器、超声波传感器、位移传感器、速度传感器、加速度传感器、扭距传感器、红外传感器、紫外传感器、火焰传感器、激光传感器、振动传感器、轴角传感器、光电传感器、接近传感器、干簧管传感器、继电器传感器、微型电泵、磁敏（阻）传感器、压力开关、接近开关、光电开关、色标传感器、光纤传感器、齿轮测速传感器、时间继电器、计数器、计米器、温控仪、固态继电器、调压模块、电磁铁、电压表、电流表等特殊传感器。同时承接传感器应用电路、产品设计和自动化工程项目。

欢迎索取免费详细资料、设计指南和光盘；产品凡多，未能尽录，欢迎来电查询。

更多产品请看本公司产品专用销售网站：

商斯达中国传感器科技信息网：<http://www.sensor-ic.com/>

商斯达工控安防网：<http://www.pc-ps.net/>

商斯达电子元器件网：<http://www.sunstare.com/>

商斯达微波光电产品网：[HTTP://www.rfoe.net/](http://www.rfoe.net/)

商斯达消费电子产品网：<http://www.icasic.com/>

商斯达军工产品网：<http://www.junpinic.com/>

商斯达实业科技产品网：<http://www.sunstars.cn/>传感器销售热线：

地址：深圳市福田区福华路福庆街鸿图大厦1602室

电话：0755-83607652 83376489 83376549 83370250 83370251 82500323

传真：0755-83376182 (0) 13902971329 MSN: SUNS888@hotmail.com

邮编：518033 E-mail: szss20@163.com QQ: 195847376

深圳赛格展销部：深圳华强北路赛格电子市场2583号 电话：0755-83665529

技术支持：0755-83394033 13501568376

▶TGS 传感器通用资料下载				
半导体气体传感器 (品牌: 日本 Figaro)				
型号	测量气体	量程(ppm)	灵敏度(电阻比)	典型应用
TGS2600-B00	香烟气, 氢气, 酒精, 甲烷, CO	1~30	0.3~0.6	空气清新机, 换气空调
TGS2602-B00	甲苯, 乙醇, H ₂ S, NH ₃ , H ₂ 等	1~30	0.15~0.5	空气清新监测仪
TGS2100	油烟气, 氢气, 燃气	1~30	0.2~0.6	抽油烟机, 空气清新机
TGS2104	汽油机尾气(H ₂ , CO, HC)	10~1000	0.3~0.6	汽车尾气检测
TGS2201	汽油/柴油机尾气(NO, NO ₂)	10~100/0.1~10	0.35/2.5	
TGS813	易燃气体(甲、丙、丁烷)	500~10,000	0.60±0.05	家庭燃气泄漏报警器
TGS816	易燃气体(甲、丙、丁烷)	500~10,000	0.60±0.05	工业用易燃, 易爆
TGS2610-B00	易燃气体(丁烷)<圆型, 酒精过滤>	500~10,000	0.53±0.05	民用/工业用易燃, 易爆
TGS2610-J00	易燃气体(丁烷) <方型>	500~10,000	0.53±0.05	民用/工业用易燃, 易爆
TGS2611-B00	天然气(甲烷)<圆型, 酒精过滤>	500~10,000	0.60±0.06	气体探测气, 报警器
TGS2611-C00	天然气(甲烷)<圆型>	500~10,001	0.60±0.06	气体探测气, 报警器
TGS821	氢气	30~1000	0.6~1.20	
TGS2442	一氧化碳	30~1,000	0.23~0.49	室内气体报警器
TGS2620-A00	酒精(金属外壳)	50~5,000	0.35±0.1	酒精探测器
TGS2620-C00	酒精(不锈钢外壳)	50~5,000	0.35±0.1	酒精探测器
TGS822	酒精	50~5,000	0.40±0.1	醉酒度测试仪
TGS825	硫化氢	5~100	0.3~0.6	有毒有害气体报警器
TGS826	氨气	30~300	0.4~0.70	电冰箱气

				体探测
TGS830	R-113,R-22,R-11,R-12	100~3,000	0.30±0.10	卤素检漏仪,
TGS831	R-21,R-22	100~3,000	0.40±0.15	氟利昂检测器
TGS832	R-134a	100~3,000	0.50~0.65	
KE-25	氧气 (电学式, 5 年寿命)	0~100%	±1%	氧气分析仪
KE-50	氧气 (电学式, 10 年寿命)	0~100%	±2%	氧气分析仪
KE-25F3	氧气 (电学式, 5 年寿命)	0~100%	±1%	氧气分析仪
TGS4160	二氧化碳 (固态, 10 年寿命)	350~30000ppm	±20%@1000ppm	蔬菜大棚, 孵化设备
TGS4161	二氧化碳 (固态, 10 年寿命)	350~5000ppm	±20%@1000ppm	蔬菜大棚, 孵化设备
AM-4	二氧化碳模块, 用于检测 TGS4160, 重新标定 TGS4160			CO2 检测
AM-4-4161	二氧化碳模块, 用于检测 TGS4161, 重新标定 TGS4161		(小尺寸,低功耗)	CO2 检测
COM2442	一氧化碳检测模块, 设置 30、70、150ppm 三档报警			
LPM2610	TGS2610 检测模块, 可以用于居民区液化石油气泄露报警	500~10000ppm		
NGM2611	TGS2611 检测模块, 可以用于居民区天然气泄露报警	500~10000ppm		
AMS2600	TGS2600 检测模块, 可以用于空调、空气清新机等家电	1~30ppm		
AMS2100	TGS2100 检测模块, 可以用于智能抽油烟机厨房电器			
AM-1-2600	TGS2600 检测模块, 检测低浓度的空气污染物 (带微处理器)			

日本 FIGARO

TGS 8 系列传感器 8-Series TGS Sensor

产品/型号	产品样图	用途	主要检测对象	检测范围	使用电压	消耗功率	特徵	详细
TGS813		可燃气体检测	甲烷、丙烷 异丁烷	500~10,000ppm	DC5V	835mW	可燃气体泄漏 报警器应用 30 年业绩	

TGS822		有机溶剂检测	酒精有机溶剂	50~5,000ppm	DC5V	660mW	有机溶剂、 酒精检测报警器 应用 20 年业绩
TGS822TF		煤制气检测	煤制气中氢气	200~5,000ppm	DC5V	660mW	煤制气泄漏报警器 应用 10 年业绩
TGS203S		不完全燃烧 气体检测	一氧化碳	50~1,000ppm	H/L 驱动	295/33mW (ave.138mW)	防一氧化碳中毒 报警器应用 20 年业绩

TGS2000 系列气体传感器 TGS2000-Series Gas Sensor

产品/型号	产品样图	用途	主要检测对象	检测范围	使用电压	消耗功率	特徵	详细
TGS2600		空气质量控制	香烟酒精	1~10ppm	DC5V	210mW	空气清新机应用业绩 空气质量控制器	
TGS2602		空气质量控制	酒精氨气 VOC	1~10ppm	DC5V	280mW	空气清新机应用业绩 空气质量控制器	
TGS2610		可燃气体检测	丙烷异丁烷	500~10,000ppm	DC5V	280mW	石油液化气泄漏报警器应用业绩低功耗	
TGS2611		可燃气体检测	甲烷天然气	500~10,000ppm	DC5V	280mW	天然气泄漏报警器应用业绩低功耗	
TGS2620		有机溶剂检测	酒精有机溶剂	50~5,000ppm	DC5V	210mW	有机溶剂检测方面 业绩低功耗	
TGS2442		毒性气体检测	一氧化碳	30~1,000ppm	DC5V 脉冲 驱动	14mW(ave.)	一氧化碳报警器应用业绩低功耗平均 约 14mW	









产品型号 产品样图 用途 主要检测气体 检测浓度范围 工作电压 功率 详细



TGS203S		毒性气体检测	<ul style="list-style-type: none"> • 一氧化碳 	50~1000ppm	H/L 驱动	295/33mW	详细
TGS813		可燃性气体	<ul style="list-style-type: none"> • 甲烷 • 丙烷 • 丁烷 	500~10000ppm	DC5V	835mW	详细
TGS2610		可燃性气体	<ul style="list-style-type: none"> • 丙烷 • 丁烷 	500~10000ppm	DC5V	280mW	详细
TGS2611		可燃性气体	<ul style="list-style-type: none"> • 甲烷 	500~10000ppm	DC5V	280mW	详细
TGS2620		溶剂蒸气	<ul style="list-style-type: none"> • 酒精 • 有机溶剂 	50~5000ppm	DC5V	280mW	详细
TGS822		溶剂蒸气	<ul style="list-style-type: none"> • 酒精 • 有机溶剂 	50~5000ppm	DC5V	660mW	详细
TGS822TF		可燃性气体	<ul style="list-style-type: none"> • 人工煤制气中 • 氢气 	200~5000ppm	DC5V	660mW	详细
TGS2600		空气质量控制	<ul style="list-style-type: none"> • 氢气 • 酒精 	1~10ppm	DC5V	210mW	详细
TGS2602		空气质量控制	<ul style="list-style-type: none"> • 酒精 • 氨气 • 有机溶剂 • 挥发 	1~10ppm	DC5V	280mW	详细
<ul style="list-style-type: none"> • TGS821 • TGS825 • TGS826 • TGS830 • TGS2442 • TGS3870 • TGS4160 	由【日本费加罗技研株式会社】生产		<ul style="list-style-type: none"> • 氢气 • 硫化氢 • 氨气 胺 • 氟利昂 有机氯气 • 一氧化碳 • 甲烷 一氧化碳(复合型) 				详细

- TGS4161
- TGS6810
- TGS6812
- TGS5042
- 二氧化碳
- 二氧化碳
- 可燃气体
- 可燃气体
- 一氧化碳

Select by application

>>Domestic safety







Model	Target gas	Typical detection range	Ps	Description	Data sheet
TGS2442	Carbon monoxide	30 - 1,000ppm	14mW	Compact size Low sensitivity to alcohol vapor For residential CO detectors	
TGS2610-D00	LP gas	500 - 10,000ppm	280mW	High selectivity to LP gas Good durability For residential gas alarms	
TGS2610-C00	LP gas	500 - 10,000ppm	280mW	Quick gas response For leak checkers	
TGS2611-E00	Methane	500 - 10,000ppm	280mW	High selectivity to methane gas Good durability For residential gas alarms	
TGS2611-C00	Methane	500 - 10,000ppm	280mW	Quick gas response For leak checkers	
TGS2612	Methane ,LP gas	500 - 10,000ppm	280mW	Stable relative sensitivity between CH4 & LP gas Good durability For residential gas alarms	
TGS3870	Methane & CO	500 - 12,500ppm 50 - 1,000ppm	38mW	Dual gas detection with one sensor For residential gas detectors	
TGS5042	Carbon monoxide	0 - 1,000ppm	No power required	Electrochemical type Battery operable Long life	
TGS6810	LP gas ,Methane	0 - 100%LEL	525mW	Catalytic type Wide detection range Linear output For residential gas alarms	

LPM2610	LP gas	500 - 10,000ppm	280mW	Precalibrated module with TGS2610 and temperature compensation circuit For residential gas detectors	
NGM2611	Methane	500 - 10,000ppm	280mW	Precalibrated module with TGS2611 and temperature compensation circuit For residential gas detectors	

Select by application

Application example>>

>>Air quality control







Model	Target gas	Typical detection range	Ps	Description	Data sheet
TGS2600	General air contaminants	1 - 30ppm	210mW	High sensitivity to air contaminants For indoor air quality control and automatic control in cooker hoods	
TGS2602	General air contaminants	1 - 30ppm	280mW	High sensitivity to VOCs and odorous gases For indoor air quality control Wide detection range Good durability	
TGS4160	Carbon dioxide	350 - 50,000ppm	1.25W	For indoor ventilation control and CO2 monitoring in factories, agriculture and automobiles Low power Compact size	
TGS4161	Carbon dioxide	350 - 10,000ppm	250mW	For indoor ventilation control in residences and high occupancy buildings	
AMS2600	General air contaminants	1 - 30ppm	210mW	Precalibrated module with TGS2600 and suitable load resistor For indoor air quality control	
CDM4160	Carbon dioxide	400-45,000ppm	1.3W	Precalibrated module Maintenance free For indoor ventilation control	
CDM4161	Carbon dioxide	400-9,000ppm	300mW	Precalibrated module Maintenance free For indoor ventilation control	

Select by application

Application example>>

>>Automotive





Model	Target gas	Typical	Ps	Description	Data
-------	------------	---------	----	-------------	------

		detection range			sheet
TGS2201	Gasoline & diesel exhaust	10 - 1,000ppm 0.1 - 10ppm	502mW	Dual gas detection with one sensor For automobile ventilation control High sensitivity to air contaminants	--
TGS2600	General air contaminants	1 - 30ppm	210mW	For indoor air quality control and automatic control in cooker hoods High sensitivity to VOCs and odorous	
TGS2602	General air contaminants	1 - 30ppm	280mW	gases For indoor air quality control High selectivity to LP gas	
TGS2610-D00	LP gas	500 - 10,000ppm	280mW	Good durability For residential gas alarms	
TGS2610-C00	LP gas	500 - 10,000ppm	280mW	Quick gas response For leak checkers	
AMS2600	General air contaminants	1 - 30ppm	210mW	Precalibrated module with TGS2600 and suitable load resistor For indoor air quality control	
LPM2610	LP gas	500 - 10,000ppm	280mW	Precalibrated module with TGS2610 and temperature compensation circuit For residential gas detectors	

Select by application

Application example>>

>>Appliance control







Model	Target gas	Typical detection range	Ps	Description	Data sheet
TGS2180	Water vapor	1 - 150g/m3	830mW	High selectivity to water vapor For automatic cooking control in microwave ovens	
TGS2600	General air contaminants	1 - 30ppm	210mW	High sensitivity to air contaminants For indoor air quality control and automatic control in cooker hoods	
TGS2602	General air contaminants	1 - 30ppm	280mW	High sensitivity to VOCs and odorous gases For indoor air quality control	
AMS2600	General air contaminants	1 - 30ppm	210mW	Precalibrated module with TGS2600 and suitable load resistor For indoor air quality control	

Select by application

Application example>>

>>Industrial safety

Model	Target gas	Typical detection range	Ps	Description	Data sheet
TGS821	Hydrogen	30 - 1,000ppm	660mW	High sensitivity and selectivity to hydrogen Ceramic base resistant to severe environments For hydrogen detectors	
TGS825	Hydrogen sulfide	5 - 100ppm	660mW	Ceramic base resistant to severe environments For hydrogen sulfide detectors	
TGS826	Ammonia	30 - 300ppm	833mW	Ceramic base resistant to severe environments For leak detection from refrigerators	
TGS832	Halocarbon gas	100 - 3,000ppm	835mW	For leak detection from refrigerators and air conditioners Ceramic base resistant to severe environments For halocarbon detectors	
TGS2442	Carbon monoxide	30 - 1,000ppm	14mW	Compact size Low sensitivity to alcohol vapor For residential CO detectors	
TGS2444	Ammonia	10 - 100ppm	56mW	High selectivity to ammonia Low power consumption For ventilation control in agricultural & poultry industries	
TGS2610-D00	LP gas	500 - 10,000ppm	280mW	High selectivity to LP gas Good durability For residential gas alarms	
TGS2610-C00	LP gas	500 - 10,000ppm	280mW	Quick gas response For leak checkers	
TGS2611-E00	Methane	500 - 10,000ppm	280mW	High selectivity to methane gas Good durability For residential gas alarms	
TGS2611-C00	Methane	500 - 10,000ppm	280mW	Quick gas response For leak checkers	
TGS2620	Alcohol ,Solvent vapors	50 - 5,000ppm	210mW	Compact size For breath alcohol testers and solvent detectors	
TGS3870	Methane & CO	500 - 12,500ppm 50 - 1,000ppm	38mW	Dual gas detection with one sensor For residential gas detectors	

TGS6812	Hydrogen ,Methane ,LP gas	0 - 100%LEL	525mW	Catalytic type Wide detection range Linear output For hydrogen and combustible gas leak detectors for fuel cells	
FCM6812	Hydrogen ,Methane ,LP gas	0 - 35%LEL	1.0W	Precalibrated module Maintenance free For gas leak detection in fuel cell systems	
LPM2610	LP gas	500 - 10,000ppm	280mW	Precalibrated module with TGS2610 and temperature compensation circuit For residential gas detectors	
NGM2611	Methane	500 - 10,000ppm	280mW	Precalibrated module with TGS2611 and temperature compensation circuit For residential gas detectors	
KE-25	Oxygen	0 - 100%	No power required	Galvanic cell type No CO2 influence Long life High accuracy	
KE-50	Oxygen	0 - 100%	No power required	Galvanic cell type No CO2 influence Long life	
SK-25	Oxygen	0 - 30%	No power required	Good linearity No CO2 influence Compact	

Select by application













Application example>>

>>Personal safety & health

Model	Target gas	Typical detection range	Ps	Description	Data sheet
TGS2620	Alcohol ,Solvent vapors	50 - 5,000ppm	210mW	Compact size For breath alcohol testers and solvent detectors	

Related products

Model	Applied sensor model	Description	Data sheet
AM-1-2600	TGS2600	Evaluation board for indoor air quality control	

AM-1-2602	TGS2602	Evaluation board for indoor air quality control	
CDM4160	TGS4160	Evaluation board for CO2 monitoring	
CDM4161	TGS4161	Evaluation board for CO2 monitoring	
COM2442	TGS2442	Evaluation board for CO detection	
FCM6812	TGS6812	Evaluation board for combustible gas detection	
SRD-1	TGS8xx	Test unit for TGS8xx series gas sensors	
FIC 00460	TGS2442	Microprocessor for CO detection	
SR-4	TGS8xx	Durable sensor socket for TGS8xx series gas sensors	
SR-5	TGS8xx	Standard sensor socket for TGS8xx series gas sensors	
SR-6	TGS26xx, TGS24xx	Standard sensor socket for TGS24xx and TGS26xx series gas sensors	
SR-8	TGS3870	Standard sensor socket for TGS38xx series gas sensors	
SR-3	TGS8xx	Test chamber for TGS8xx series gas sensors	

SUNSTAR商斯达实业集团是集研发、生产、工程、销售、代理经销、技术咨询、信息服务等为一体的高科技企业，是专业高科技电子产品生产厂家，是具有10多年历史的专业电子元器件供应商，是中国最早和最大的仓储式连锁规模经营大型综合电子零部件代理分销商之一，是一家专业代理和分销世界各大品牌IC芯片和电子元器件的连锁经营综合性国际公司。在香港、北京、深圳、上海、西安、成都等全国主要电子市场设有直属分公司和产品展示展销窗口门市部专卖店及代理分销商，已在全国范围内建成强大统一的供货和代理分销网络。我们专业代理经销、开发生产电子元器件、集成电路、传感器、微波光电元器件、工控机/DOC/DOM电子盘、专用电路、单片机开发、MCU/DSP/ARM/FPGA软件硬件、二极管、三极管、模块等，是您可靠的一站式现货配套供应商、方案提供商、部件功能模块开发配套商。专业以现代信息产业（计算机、通讯及传感器）三大支柱之一的传感器为主营业务，专业经营各类传感器的代理、销售生产、网络信息、科技图书资料及配套产品设计、工程开发。我们的专业网站——中国传感器科技信息网（全球传感器数据库）www.SENSOR-IC.COM 服务于全球高科技生产商及贸易商，为企业科技产品开发提供技术交流平台。欢迎各厂商互通有无、交换信息、交换链接、发布寻求代理信息。欢迎国外高科技传感器、变送器、执行器、自动控制产品厂商介绍产品到中国，共同开拓市场。本网站是关于各种传感器-变送器-仪器仪表及工业自动化大型专业网站，深入到工业控制、系统工程计 测量、自动化、安防报警、消费电子等众多领域，把最新的传感器-变送器-仪器仪表买卖信息，最新技术供求，最新采购商，行业动态，发展方向，最新的技术应用和市场资讯及时的传递给广大科技开发、科学研究、产品设计人员。本网站已成功为石油、化工、电力、医药、生物、航空、航天、国防、能源、冶金、电子、工业、农业、交通、汽车、矿山、煤炭、纺织、信息、通信、IT、安防、环保、印刷、科研、气象、仪器仪表等领域从事科学研究、产品设计、开发、生产制造的科技人员、管理人员、和采购人员提供满意服务。我公司专业生产、代理、经销、销售各种传感器、变送器、敏感元器件、开关、执行器、仪器仪表、自动化控制系统：专门从事设计、生产、销售各种传感器、变送器、各种测控仪表、热工仪表、现场控制器、计算机控制系统、数据采集系统、各类环境监控系统、专用控制系统应用软件以及嵌入式系统开发及应用等工作。如热敏电阻、压敏电阻、温度传感器、温度变送器、湿度传感器、湿度变送器、气体传感器、气体变送器、压力传感器、压力变送、称重传感器、物（液）位传感器、物（液）位变送器、流量传感器、流量变送器、电流（压）传感器、溶氧传感器、霍尔传感器、图像传感器、超声波传感器、位移传感器、速度传感器、加速度传感器、扭距传感器、红外传感器、紫外传感器、火焰传感器、激光传感器、振动传感器、轴角传感器、光电传感器、接近传感器、干簧管传感器、继电器传感器、微型电泵、磁敏（阻）传感器、压力开关、接近开关、光电开关、色标传感器、光纤传感器、齿轮测速传感器、时间继电器、计数器、计米器、温控仪、固态继电器、调压模块、电磁铁、电压表、电流表等特殊传感器。同时承接传感器应用电路、产品设计和自动化工程项目。

欢迎索取免费详细资料、设计指南和光盘；产品凡多，未能尽录，欢迎来电查询。

更多产品请看本公司产品专用销售网站：

商斯达中国传感器科技信息网：<http://www.sensor-ic.com/>

商斯达工控安防网：<http://www.pc-ps.net/>

商斯达电子元器件网：<http://www.sunstare.com/>

商斯达微波光电产品网：[HTTP://www.rfoe.net/](http://www.rfoe.net/)

商斯达消费电子产品网：<http://www.icasic.com/>

商斯达军工产品网：<http://www.junpinic.com/>

商斯达实业科技产品网：<http://www.sunstars.cn/>传感器销售热线：

地址：深圳市福田区福华路福庆街鸿图大厦1602室

电话：0755-83607652 83376489 83376549 83370250 83370251 82500323

传真：0755-83376182 (0) 13902971329 MSN: SUNS888@hotmail.com

邮编：518033 E-mail: szss20@163.com QQ: 195847376

深圳赛格展销部：深圳华强北路赛格电子市场2583号 电话：0755-83665529

技术支持：0755-83394033 13501568376