

溫濕度計時鐘

一) 功能特性

- 1) 工作電壓1.5V, 超低電源功耗
- 2) 基本的時間顯示, 有12/24小時轉換
- 3) 有鬧鐘顯示和5分鐘貪睡功能
- 4) 年曆範圍: 2000~2099年. (開機顯示2005年)
- 5) 可選擇攝氏或華氏顯示溫度
- 6) 溫度範圍:
室外: $-50 \sim +70 \text{ degC}$ ($-58 \sim 158 \text{ degF}$)
室內: $-10 \sim +60 \text{ degC}$ ($14 \sim +140 \text{ degF}$)
溫度精確度: $\pm 1 \text{ degC}$
溫度顯示精度: 0.1 degC
- 7) 濕度顯示範圍: 20~90%RH
濕度精確度: $\pm 5\%RH$
- 8) 有溫度和濕度趨勢
- 9) 邦定選擇室外溫度
- 10) 邦定選擇星期顯示: 英, 法, 德, 西
- 11) 有按鍵提示音

二) 液晶顯示圖案

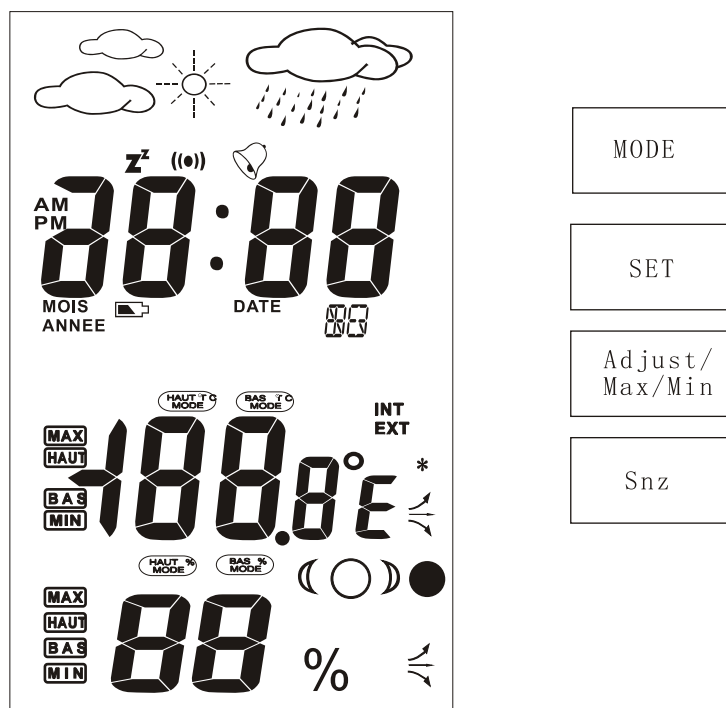

三) 流程圖

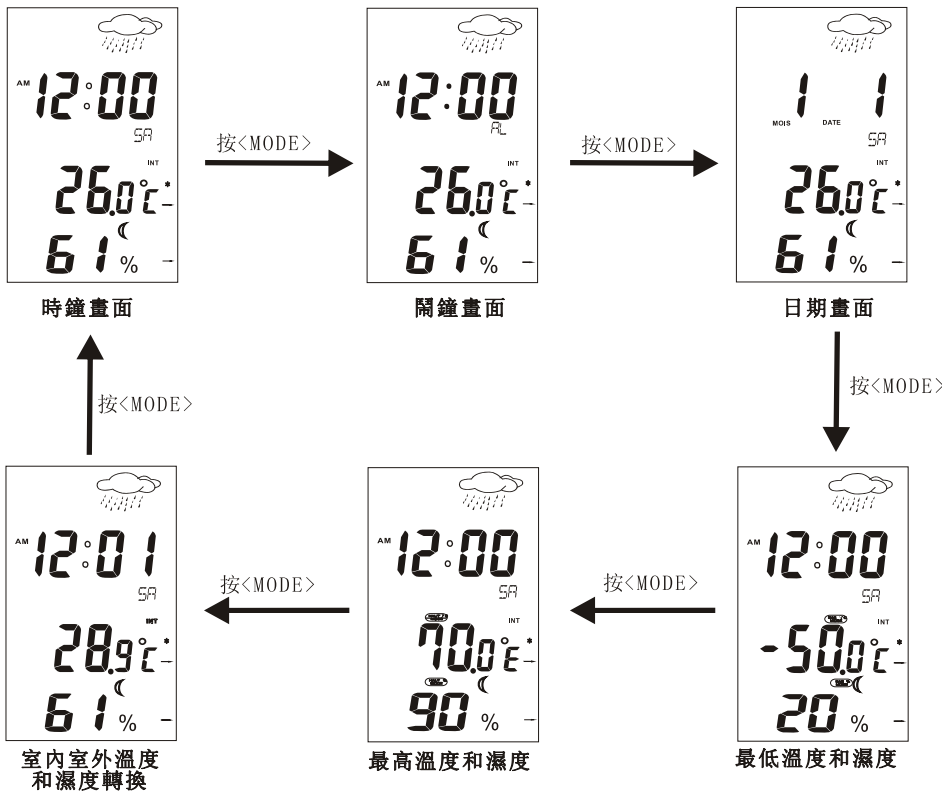

四) 操作說明

1) 設定時間

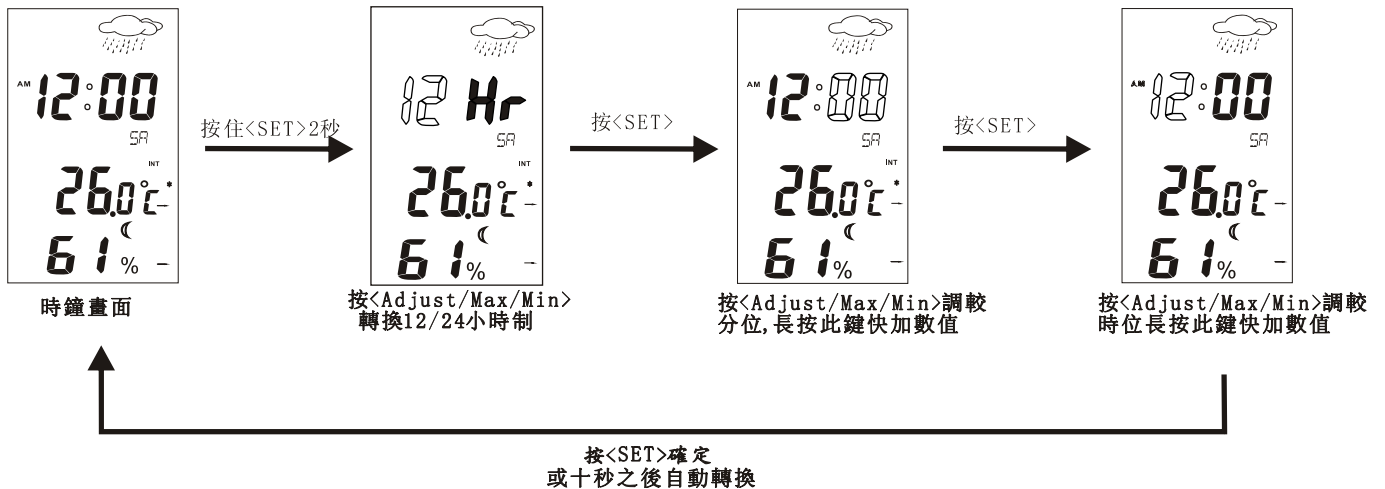

2) 設定鬧鐘

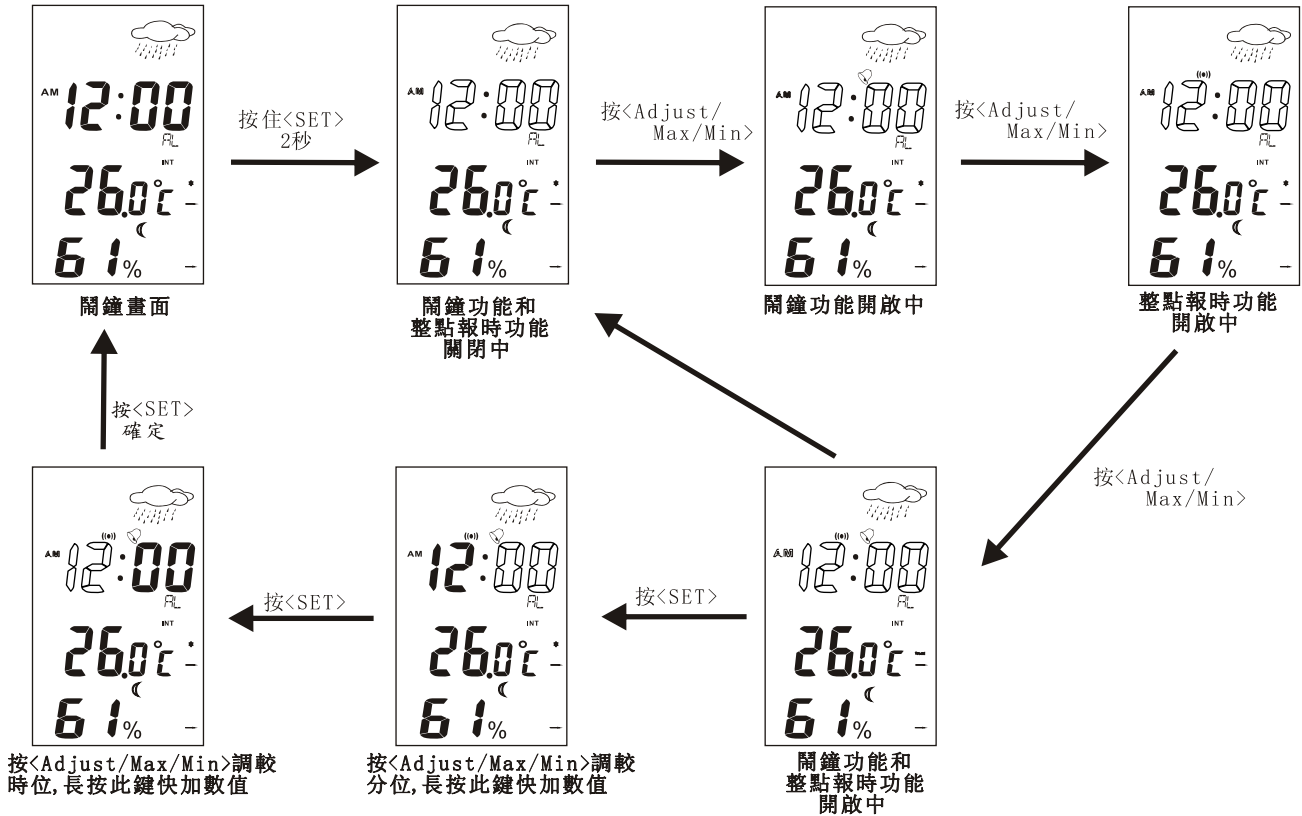

- 註: - ALM響鬧時按<SNZ>進入貪睡功能,每5分鐘響鬧一次,無限次貪睡
 - 貪睡響鬧時按其它按鍵(除SNZ鍵外)可關閉貪睡功能
 - 貪睡進行中進入設置時間或鬧鐘模式可關閉貪睡功能

3) 設定日期

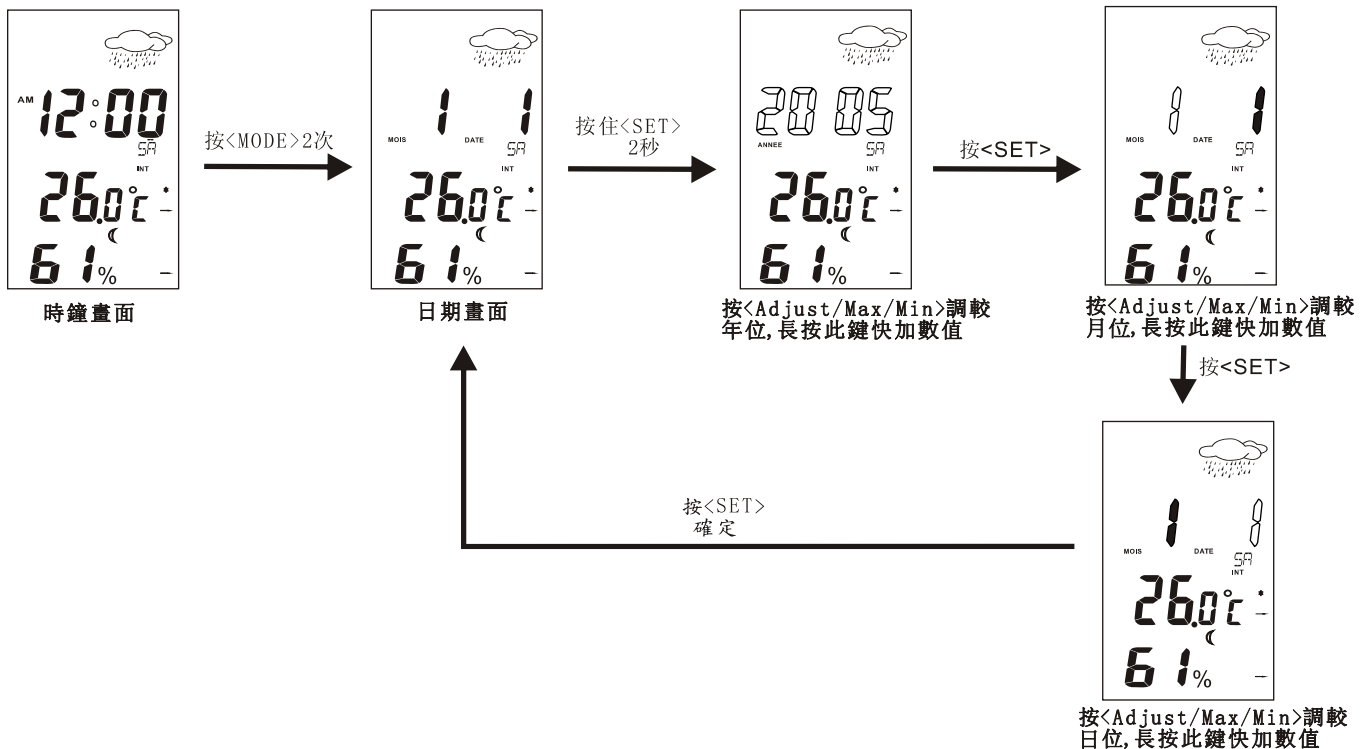

6) 轉換室內外溫濕度顯示

SUNSTAR 单片机专用电路 <http://www.icasic.com/> TEL: 0755-83387030 FAX: 0755-83376182 E-MAIL: szss20@163.com

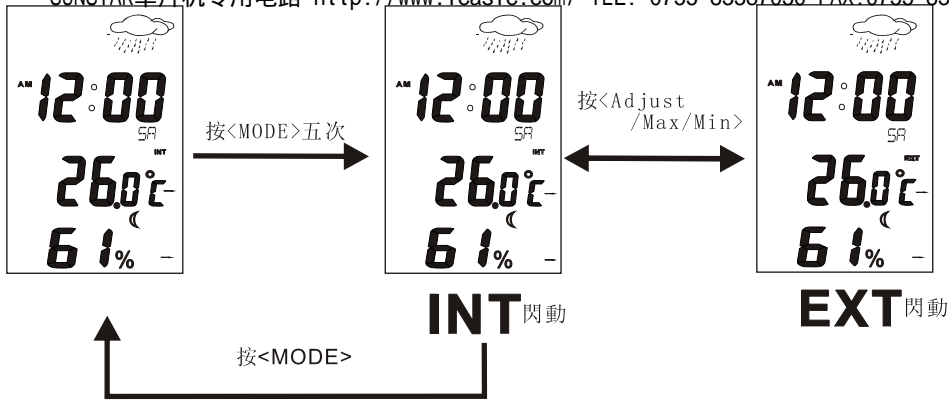

註: 於室內外顯示畫面按 <Adjust/Max/Min> 2秒, 最大和最小溫濕度記憶會被清除, 最大和最小溫濕度值隨即被設為現當的溫濕度數值。

7) 溫度趨勢畫面

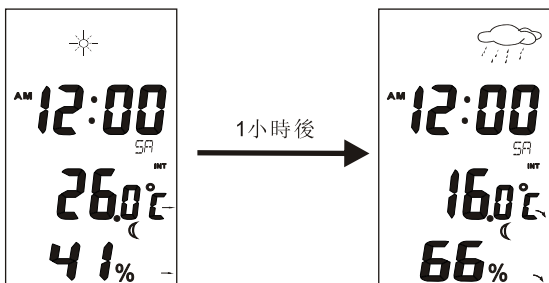
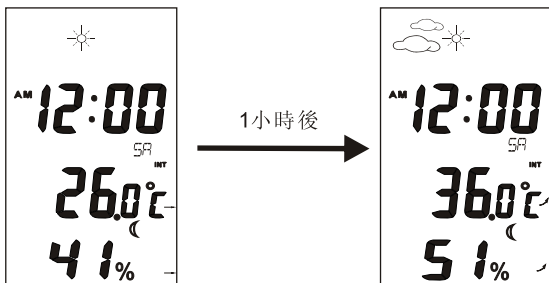
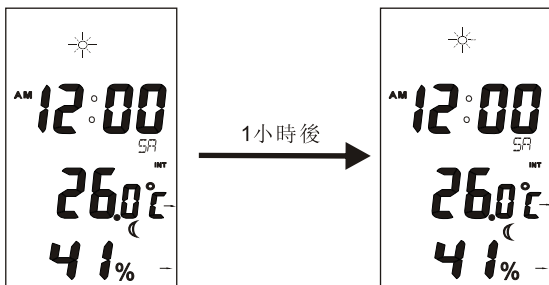

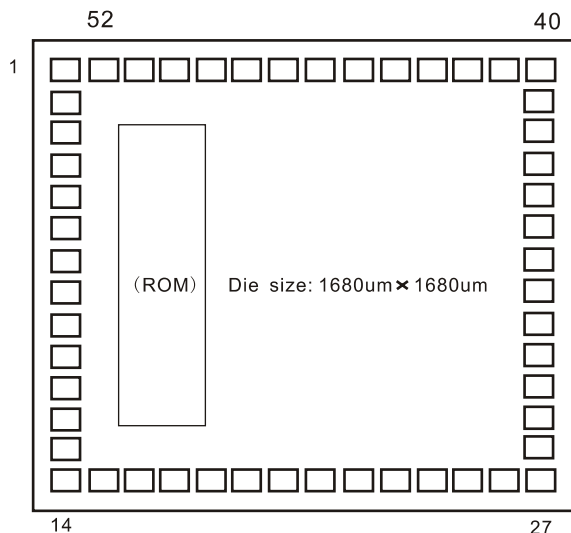

The substrate of chip should be connected to GND.

NO	NAME	X	Y	NO	NAME	X	Y
1	N.C.	77.5	1602.5	27	SEG13	1602.5	77.5
2	XIN	77.5	1472.5	28	SEG14	1602.5	207.5
3	XOUT	77.5	1357.5	29	SEG15	1602.5	322.5
4	GND	77.5	1242.5	30	SEG16	1602.5	437.5
5	VDD1	77.5	1127.5	31	SEG17	1602.5	552.5
6	VDD2	77.5	1012.5	32	SEG18	1602.5	667.5
7	VDD3	77.5	897.5	33	SEG19	1602.5	782.5
8	CUP1	77.5	782.5	34	SEG20	1602.5	897.5
9	CUP2	77.5	667.5	35	SEG21	1602.5	1012.5
10	COM1	77.5	552.5	36	SEG22	1602.5	1127.5
11	COM2	77.5	437.5	37	SEG23	1602.5	1242.5
12	COM3	77.5	322.5	38	CX	1602.5	1357.5
13	COM4	77.5	207.5	39	RR	1602.5	1472.5
14	COM5	77.5	77.5	40	RT	1602.5	1602.5
15	SEG1	207.5	77.5	41	SEG27	1472.5	1602.5
16	SEG2	322.5	77.5	42	IOB1	1372.5	1602.5
17	SEG3	437.5	77.5	43	IOB2	1242.5	1602.5
18	SEG4	552.5	77.5	44	IOB3	1127.5	1602.5
19	SEG5	667.5	77.5	45	BZ	1012.5	1602.5
20	SEG6	782.5	77.5	46	IOC1	897.5	1602.5
21	SEG7	897.5	77.5	47	IOC2	782.5	1602.5
22	SEG8	1012.5	77.5	48	IOC3	667.5	1602.5
23	SEG9	1127.5	77.5	49	IOC4	552.5	1602.5
24	SEG10	1242.5	77.5	50	RESET	437.5	1602.5
25	SEG11	1357.5	77.5	51	INT	322.5	1602.5
26	SEG12	1472.5	77.5	52	N.C.	207.5	1602.5

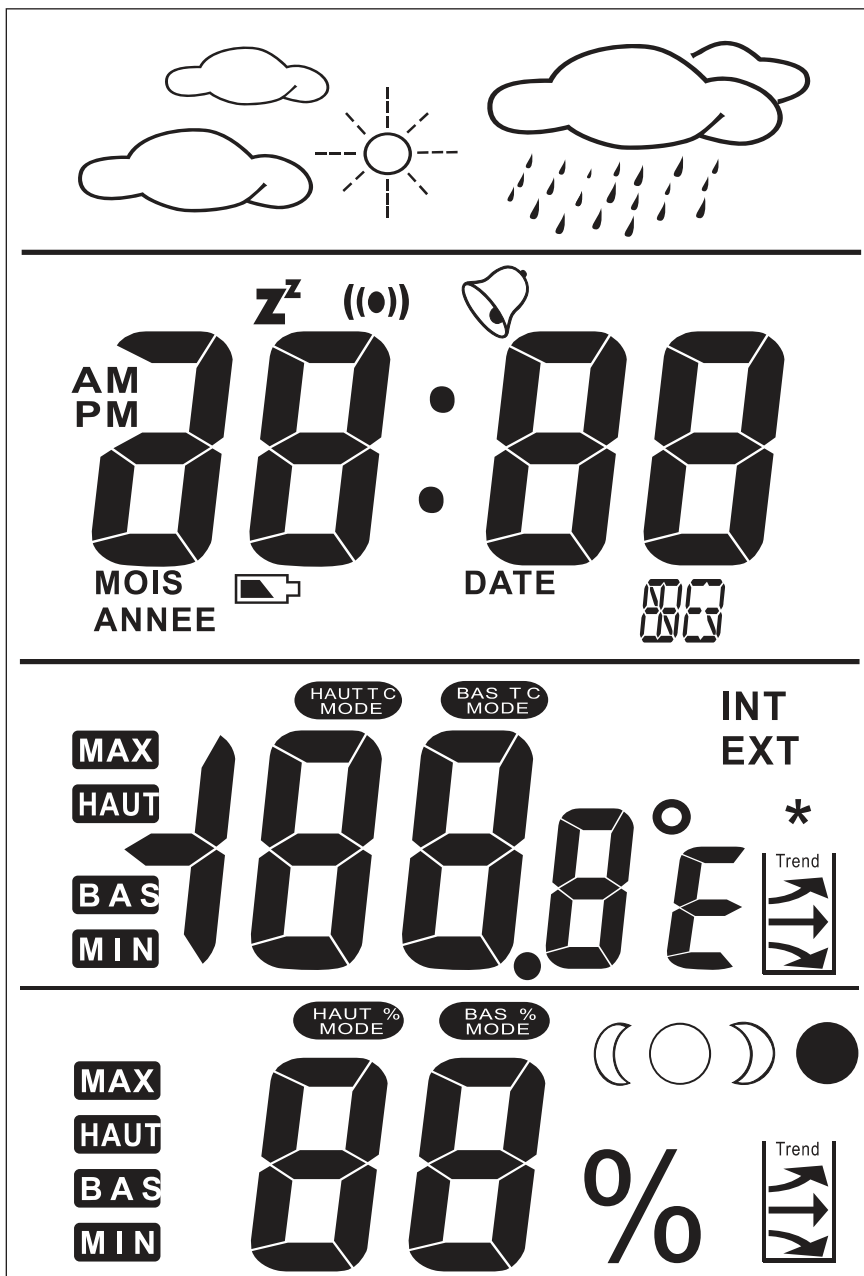

1/5 Duty, 1/3 Bias, Vlcd 4.5V

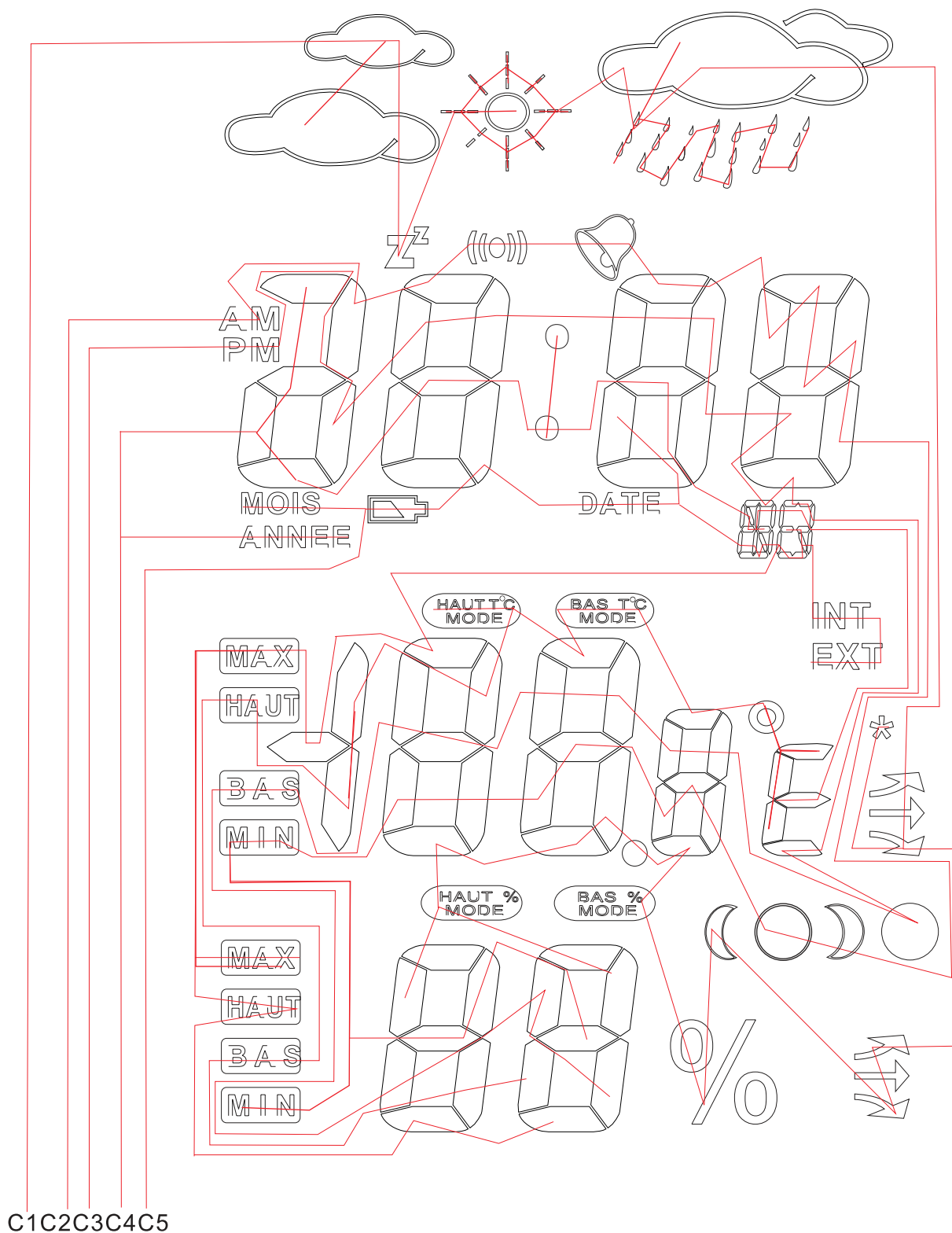

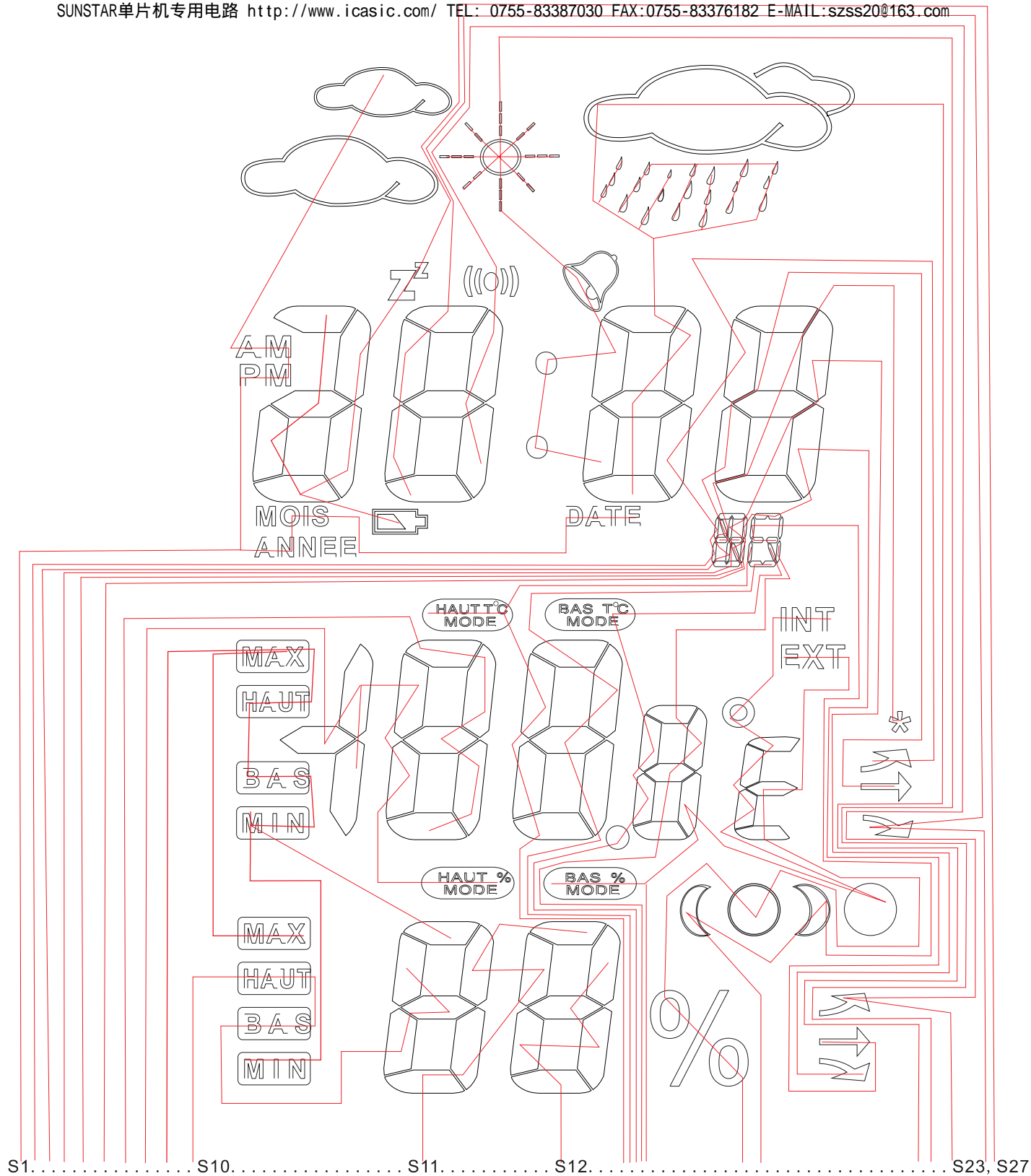

RESISTOR
VALUES ARE FOR
REFERENCE ONLY

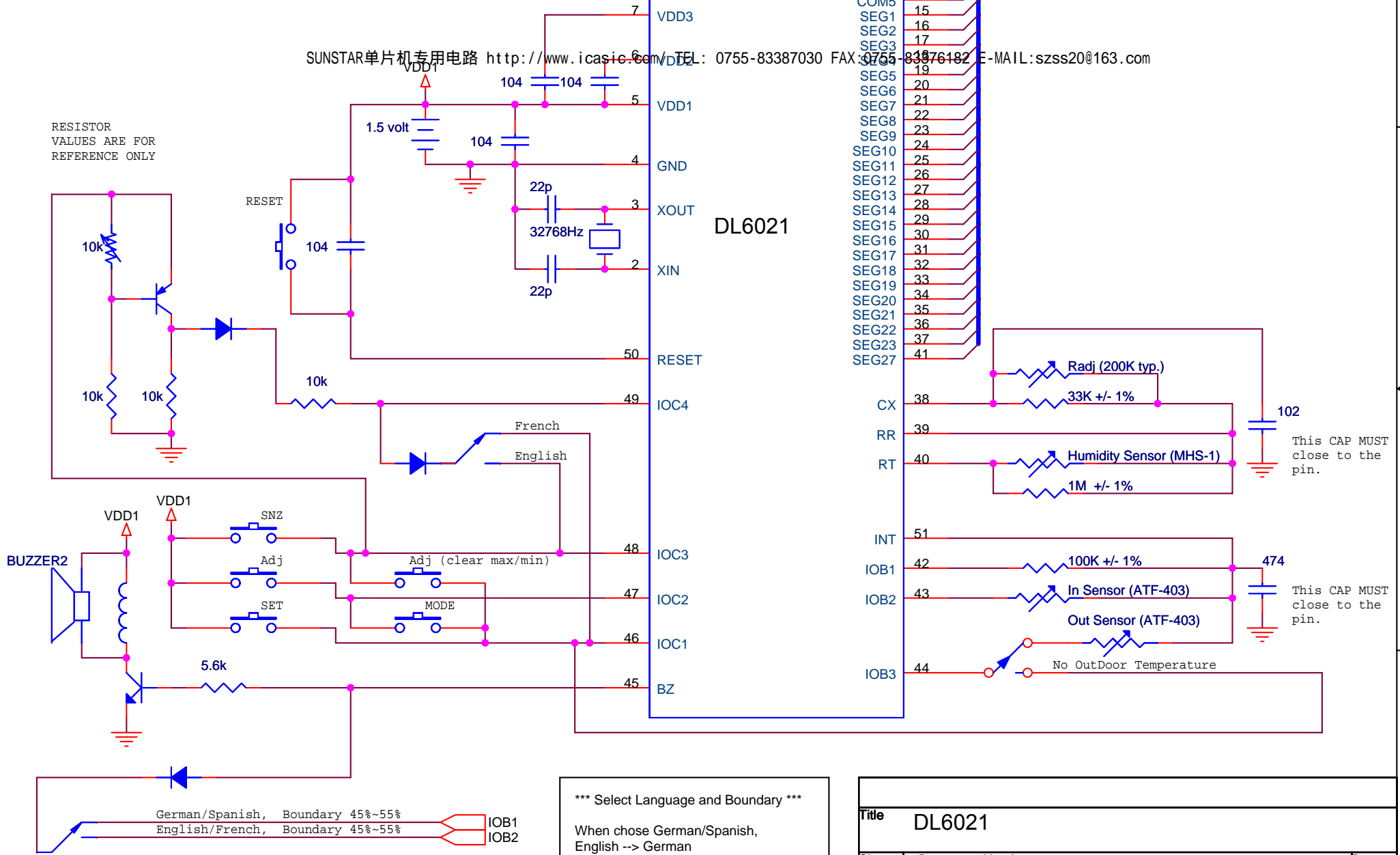

DL6021

*** Select Language and Boundary ***

When chose German/Spanish,
English --> German
French --> Spanish

German/Spanish, Boundary 45%~55%
English/French, Boundary 45%~55%

Title			DL6021		
Size	Document Number		Rev		
0755-83376182	0755-83376182		E-MAIL: szss20@163.com		1.0
Date:	Monday, June 06, 2005		Sheet	1	of 1

DL6021

SUNSTAR单片机专用电路 <http://www.icasic.com/> TEL: 0755-83376182

FAX: 0755-83376182 E-MAIL: szss20@163.com

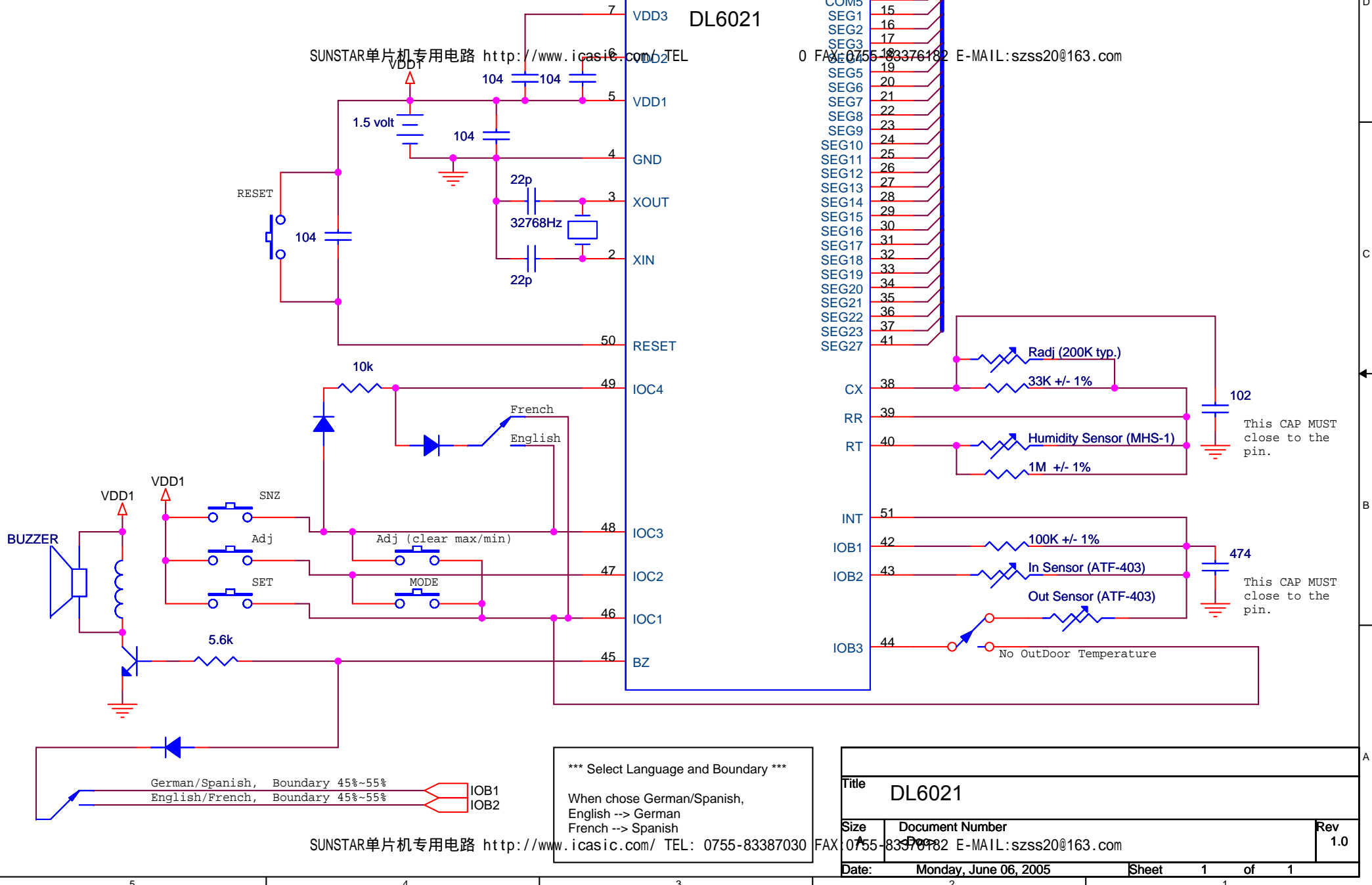

*** Select Language and Boundary ***
 When chose German/Spanish,
 English --> German
 French --> Spanish

Title		DL6021	
Size	Document Number	Rev	
0755-83376182	0755-83376182	1.0	
Date:	Monday, June 06, 2005	Sheet	1 of 1

SUNSTAR单片机专用电路 <http://www.icasic.com/> TEL: 0755-83387030 FAX: 0755-83376182

E-MAIL: szss20@163.com