

一) 功能特性

1. 工作電壓3V, 超低電源功耗
2. 時鐘功能, 12/24小時轉換
3. 年曆範圍: 2000~2099(開機2008年1月1日)
4. 自動調整星期
5. 秒錶功能, 最大範圍為: 9小時59分59秒
6. 秒錶可邦定選擇儲存30, 50 和99個紀錄(99個紀錄需要外加EEPROM)
7. 倒計時功能, 最大範圍為: 9小時59分59秒
8. 每分鐘10~320次可調節節拍器功能
9. 有按鍵提示音

二) 液晶顯示圖案(含按鍵圖)

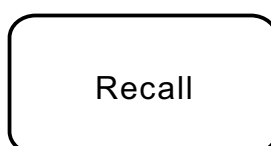
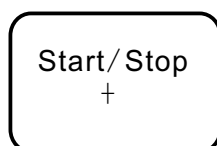
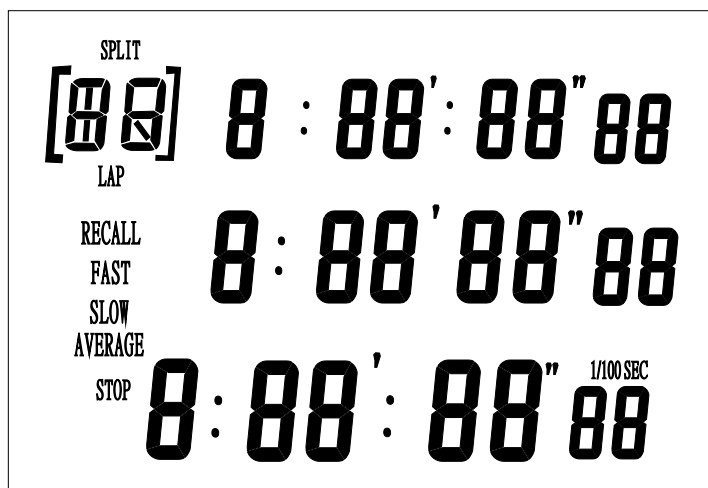

三行顯示多功能秒錶

三) 流程圖

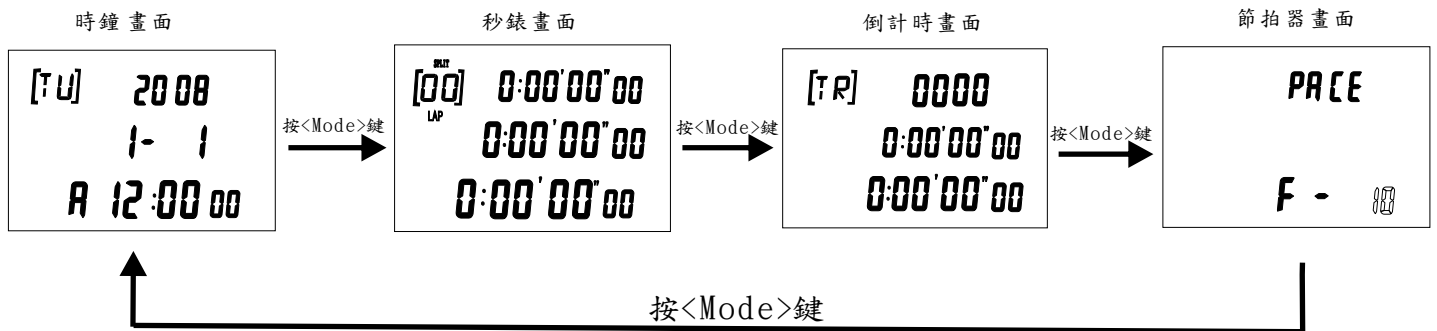

四) 時鐘模式

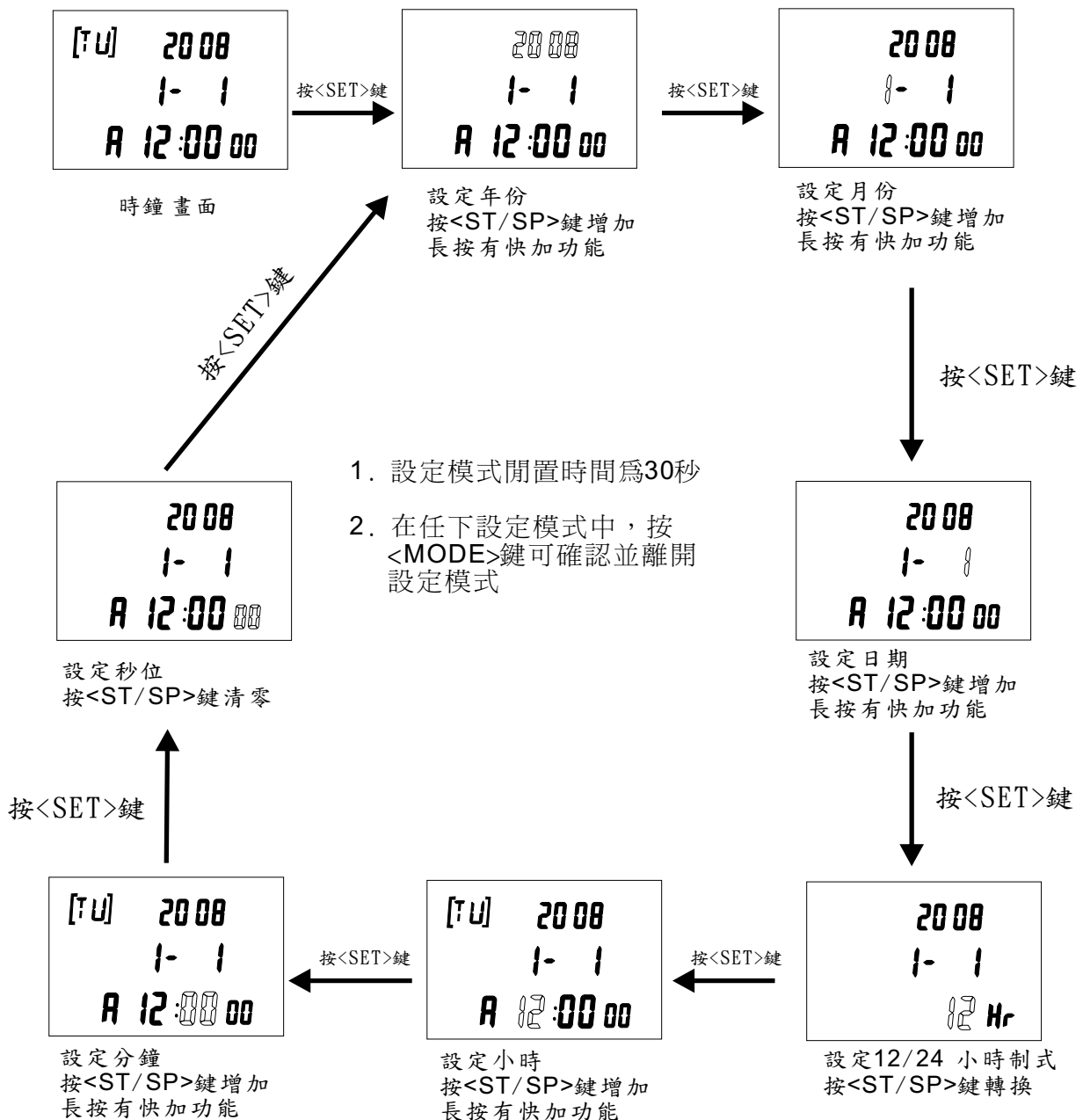

三行顯示多功能秒錶

五) 秒錶模式

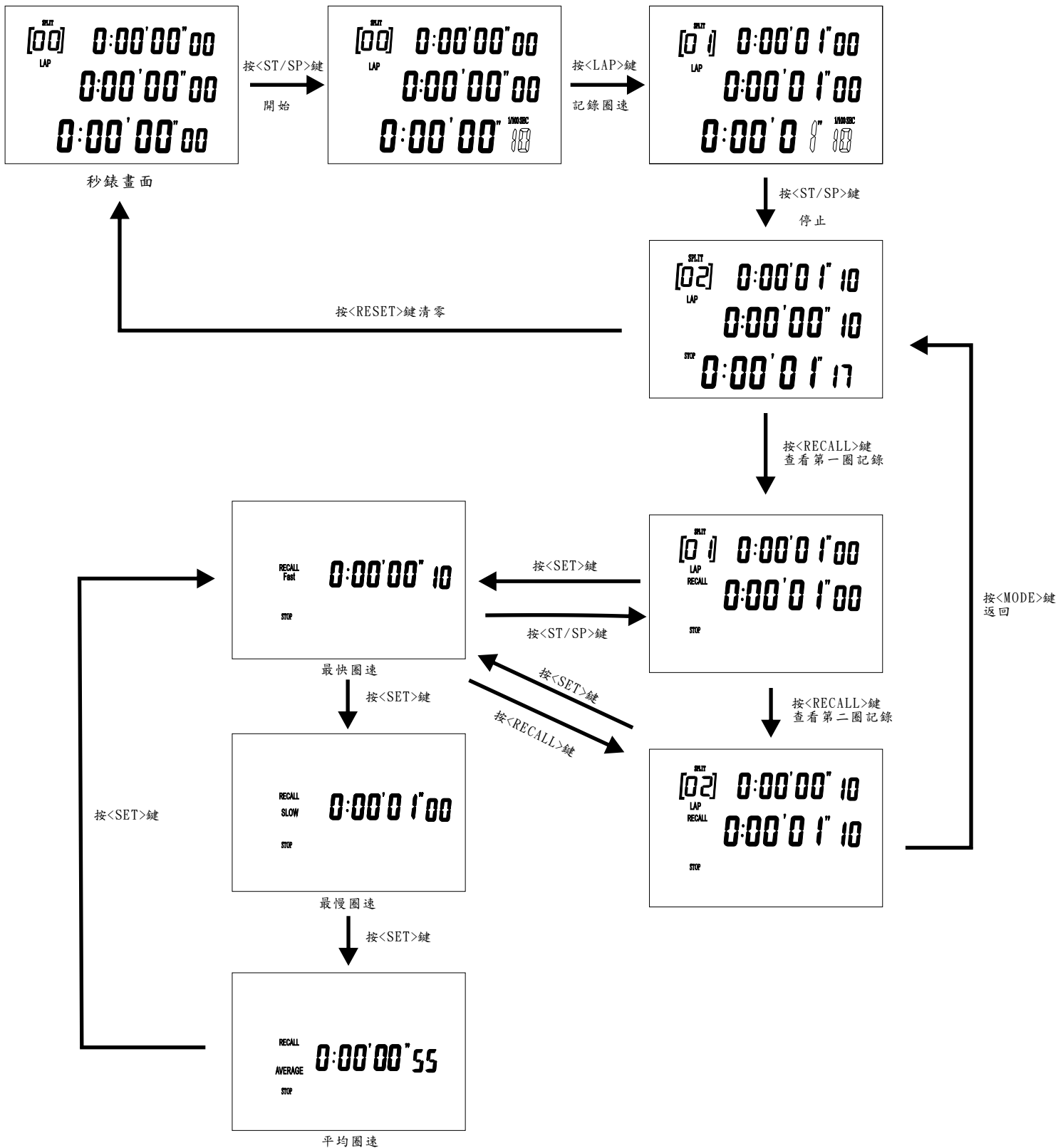

- 計時進行中時按<LAP>鍵會紀錄LAP時間, 儲存滿紀錄後再按<LAP>鍵會繼續顯示最新紀錄, 但就不會再儲存紀錄。
- 在分段圈速/最快最慢圈速畫面按<MODE>鍵會返回當前秒錶畫面
- 在秒錶運行時也可以按<RECALL>翻查已記錄的圈速記錄

六) 倒計時模式

倒計時設定

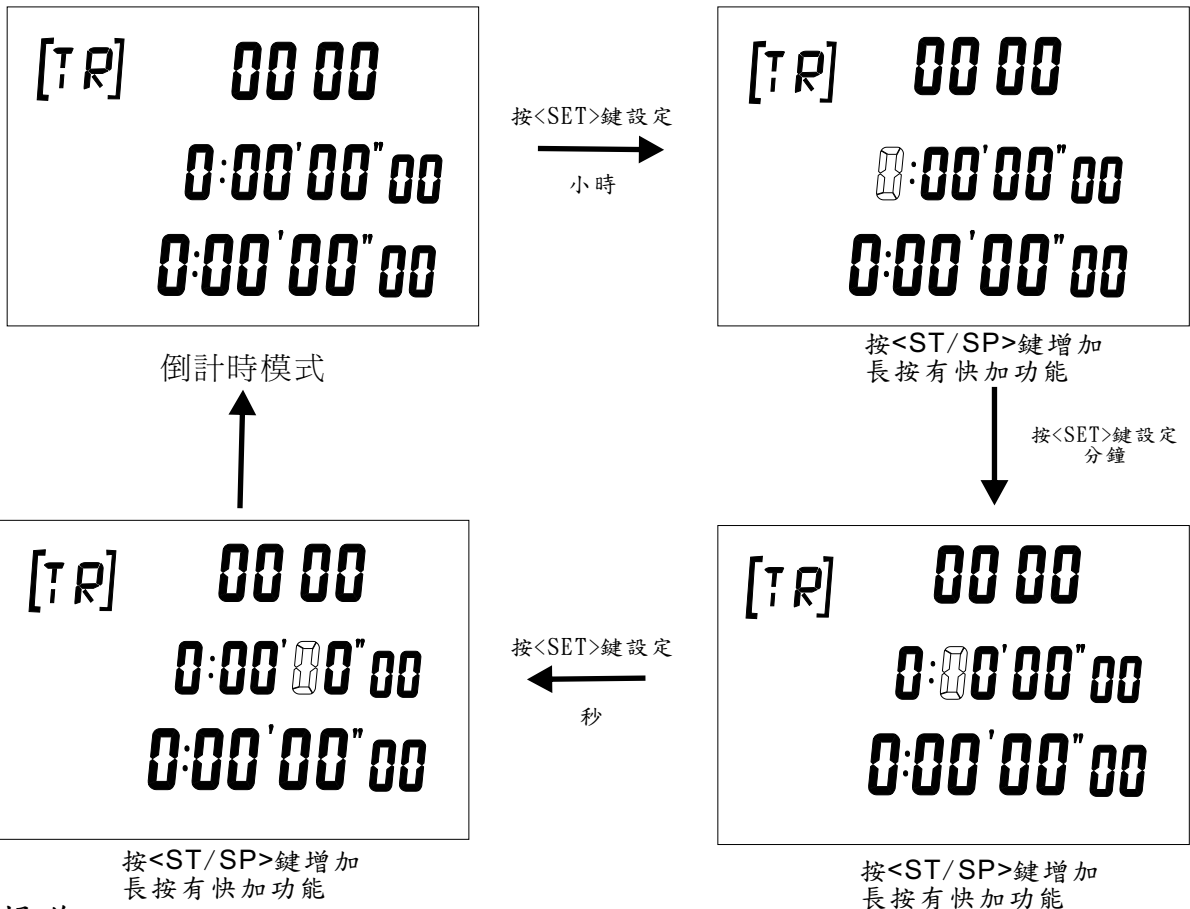

倒計時操作

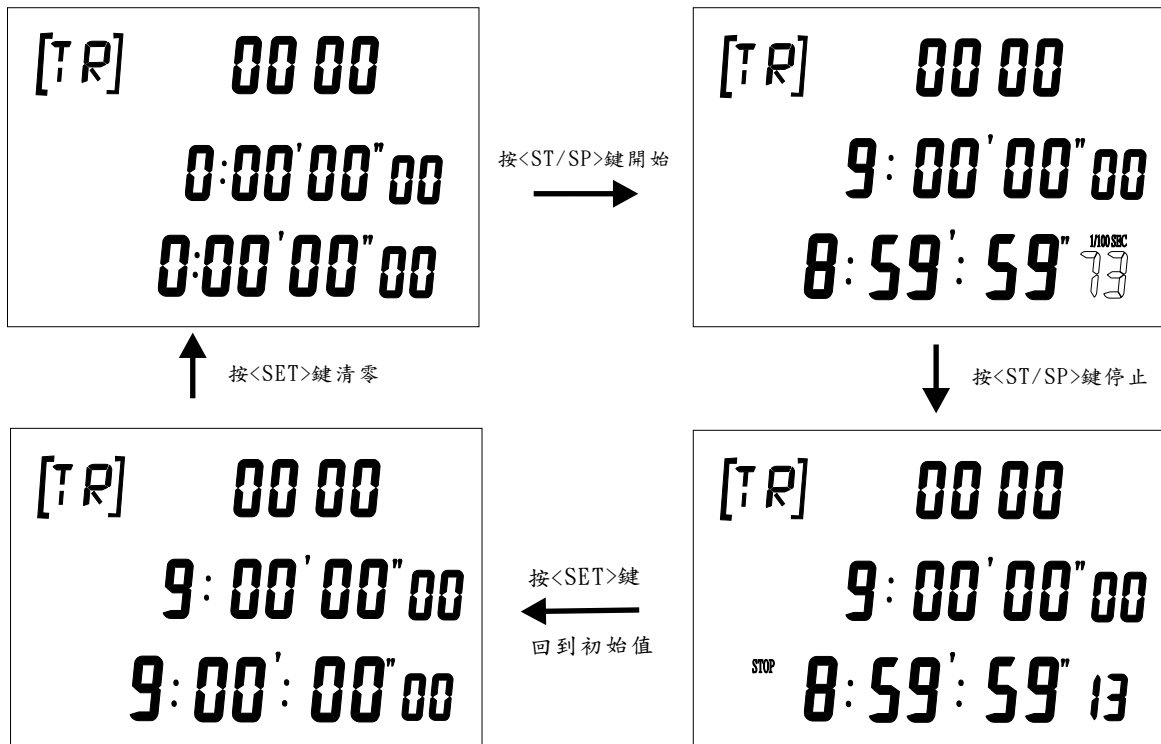

六) 節拍器模式

設定模式

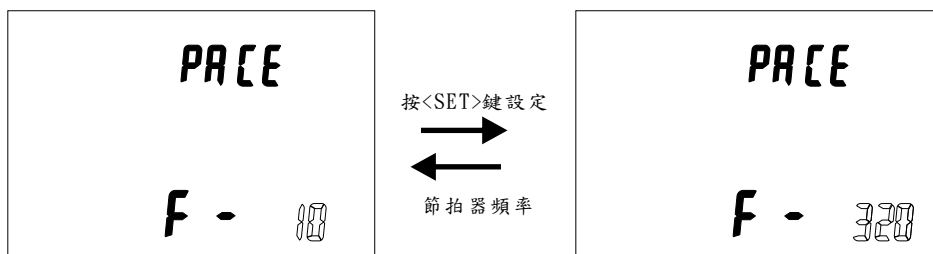

可選擇頻率有每分鐘10, 20, 30, 40, 60, 80, 120, 160, 240, 320下

操作方法

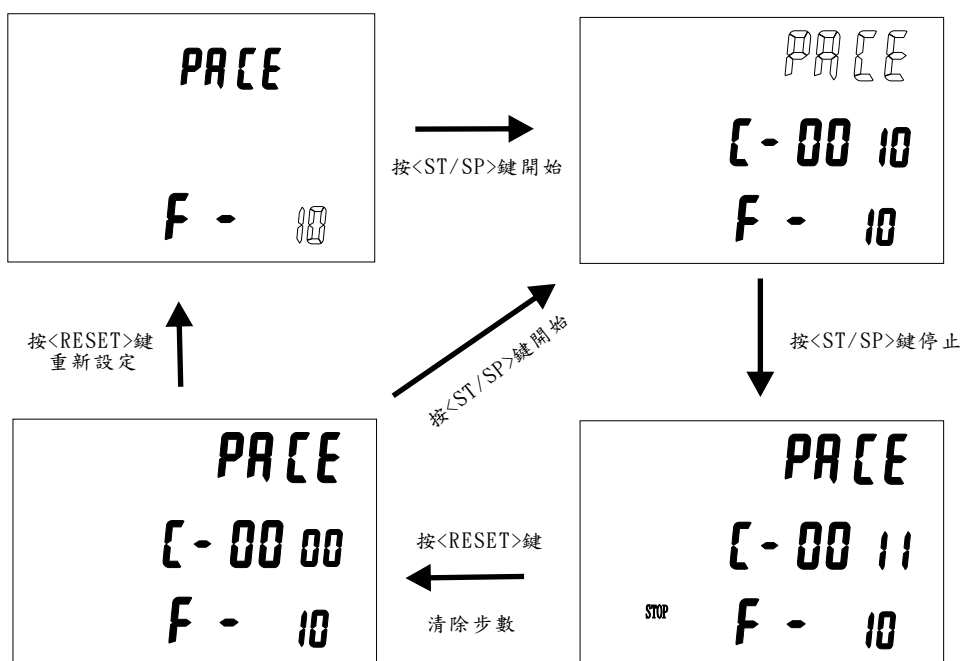

七) 星期顯示字樣

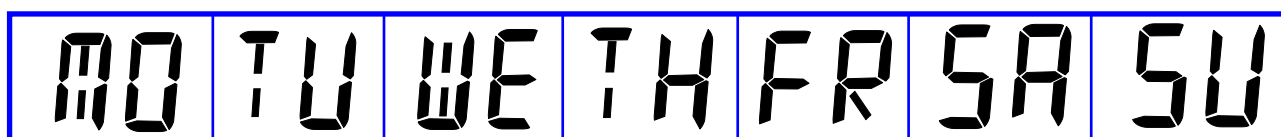

三行顯示多功能秒錶

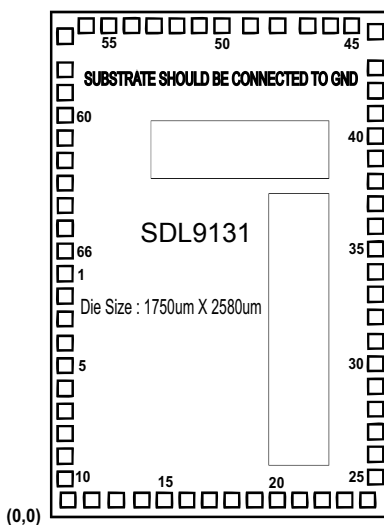

NO	NAME	X	Y	NO	NAME	X	Y
1	BAK	72.5	1229.5	34	SEG12	1677.5	1244.5
2	XIN	72.5	1114.5	35	SEG13	1677.5	1359.5
3	XOUT	72.5	999.5	36	SEG14	1677.5	1474.5
4	N.C.	72.5	884.5	37	SEG15	1677.5	1589.5
5	N.C.	72.5	769.5	38	SEG16	1677.5	1704.5
6	GND	72.5	654.5	39	SEG17	1677.5	1819.5
7	VDD1	72.5	539.5	40	SEG18	1677.5	1934.5
8	VDD2	72.5	424.5	41	SEG19	1677.5	2049.5
9	VDD3	72.5	309.5	42	SEG20	1677.5	2175.0
10	VDD4	72.5	194.5	43	SEG21	1677.5	2300.0
11	N.C.	89.5	72.5	44	SEG22	1677.5	2477.0
12	CUP1	204.5	72.5	45	SEG23	1558.5	2507.5
13	CUP2	319.5	72.5	46	SEG24	1430.45	2507.5
14	COM1	434.5	72.5	47	SEG25	1305.0	2507.5
15	COM2	549.5	72.5	48	SEG26	1164.5	2507.5
16	COM3	669.5	72.5	49	IOA4	1024.0	2507.5
17	COM4	789.5	72.5	50	IOB1	881.5	2507.5
18	COM5	909.5	72.5	51	IOB2	766.5	2507.5
19	COM6	1029.5	72.5	52	N. C.	651.5	2507.5
20	COM7	1149.5	72.5	53	BZ	536.5	2507.5
21	COM8	1269.5	72.5	54	IOC1	421.5	2507.5
22	N.C.	1389.5	72.5	55	IOC2	306.5	2507.5
23	SEG1	1509.5	72.5	56	IOC3	191.5	2507.5
24	SEG2	1629.5	72.5	57	IOC4	72.5	2477.0
25	SEG3	1677.5	197.5	58	IOD1	72.5	2300.0
26	SEG4	1677.5	322.5	59	IOD2	72.5	2175.0
27	SEG5	1677.5	439.5	60	IOD3	72.5	2049.5
28	SEG6	1677.5	554.5	61	N. C.	72.5	1934.5
29	SEG7	1677.5	669.5	62	SEG27	72.5	1819.5
30	SEG8	1677.5	784.5	63	SEG28	72.5	1704.5
31	SEG9	1677.5	899.5	64	RESET	72.5	1589.5
32	SEG10	1677.5	1014.5	65	INT	72.5	1474.5
33	SEG11	1677.5	1129.5	66	N.C.	72.5	1359.5

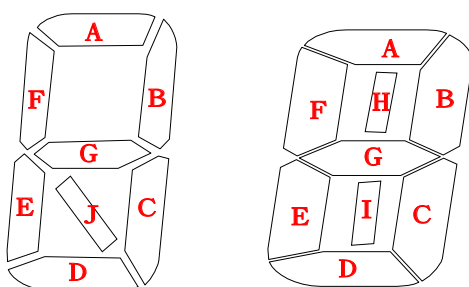
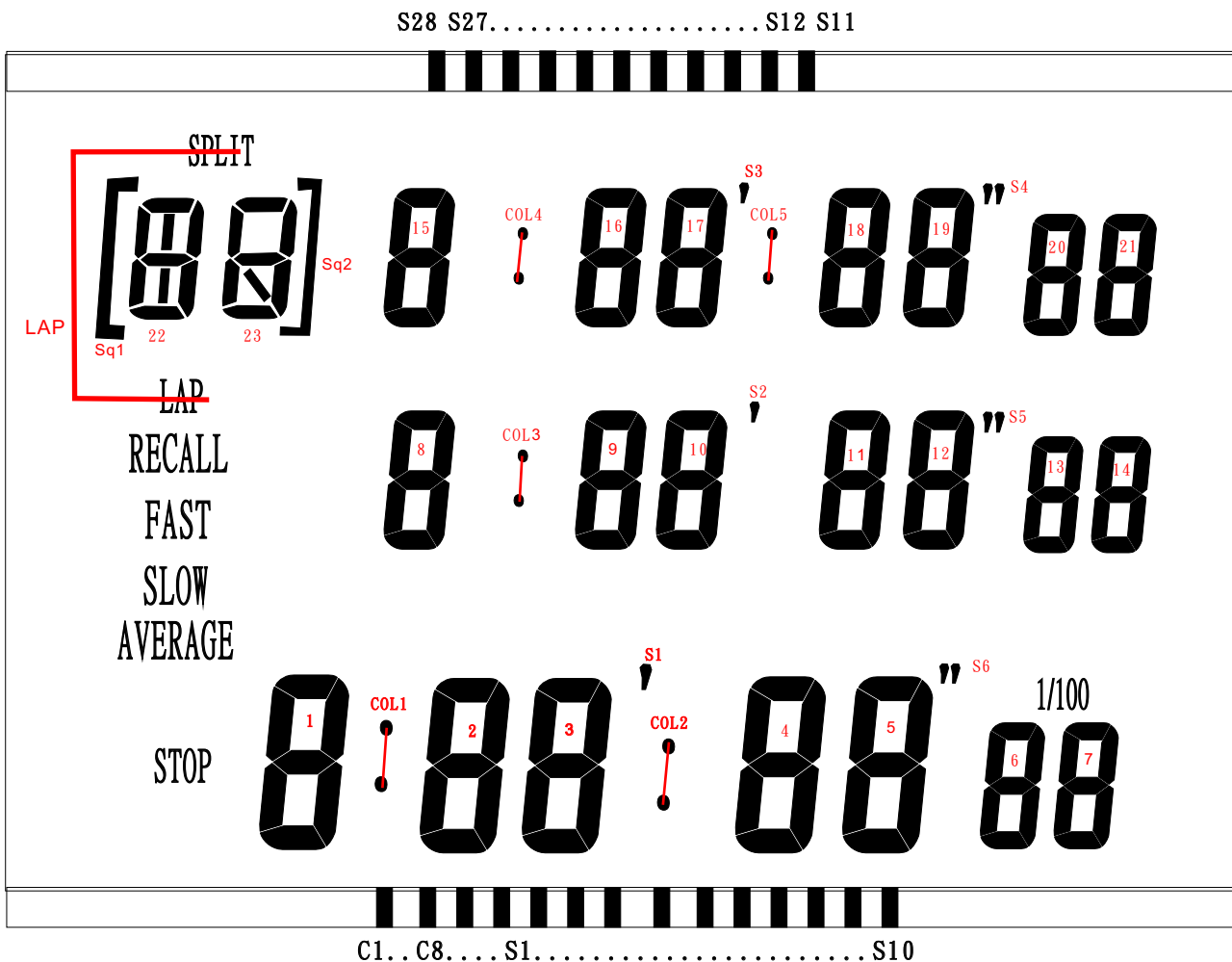

1/8 Duty, 1/3 Bias, V_{lcd}=4.5V

	SEG 1	SEG 2	SEG 3	SEG 4	SEG 5	SEG 6	SEG 7	SEG 8	SEG 9	SEG 10
COM 1	/	/	/	Sq1	/	/	/	/	/	/
COM 2	/	/	/	22A	/	/	23A	/	/	/
COM 3	/	/	FAST	22F	22H	/	23F	/	Sq2	/
COM 4	/	/	SLOW	22E	22G	22B	23E	23G	23B	/
COM 5	/	/	AVE	22D	22I	22C	23D	23J	23C	/
COM 6	LAP	RECALL	1A	COL1	8F	8A	8B	2A	3F	3A
COM 7	/	1F	1G	1B	8E	8G	2F	2G	2B	3G
COM 8	STOP	1E	1D	1C	8D	8C	2E	2D	2C	3E
	SEG 11	SEG 12	SEG 13	SEG 14	SEG 15	SEG 16	SEG 17	SEG 18	SEG 19	SEG 20
COM 1	/	21B	21A	20A	S4	19B	19A	19F	18A	COL5
COM 2	/	21F	20B	20G	20F	19C	19G	18C	18B	18F
COM 3	21C	21G	20C	20D	20E	S5	19D	19E	18D	18G
COM 4	/	21E	13B	13A	13F	12B	12A	12F	11A	18E
COM 5	14B	21D	14F	13G	13E	12C	12G	12E	11B	11G
COM 6	/	14A	14E	13C	13D	1/100	6A	12D	11C	11E
COM 7	/	14G	14D	7A	7G	7F	6B	6G	6F	11D
COM 8	/	14C	7B	7C	7D	7E	6C	6D	6E	S6
	SEG 21	SEG 22	SEG 23	SEG 24	SEG 25	SEG 26	SEG 27	SEG 28		
COM 1	S3	17A	17F	16B	16A	16F	15A	/		
COM 2	17B	17G	17E	16C	16G	15B	15F	/		
COM 3	17C	17D	10A	16D	16E	COL4	15G	/		
COM 4	S2	10B	10F	9B	9A	15C	15E	/		
COM 5	11F	10G	10E	9C	9G	9F	15D	/		
COM 6	5A	10C	10D	4A	9D	9E	COL3	3B		
COM 7	5B	5G	5F	4B	4G	4F	S1	3C		
COM 8	5C	5D	5E	4C	4D	4E	COL2	3D		

SUNSTAR单片机专用电路 <http://www.icasic.com/>

TEL: 0755-83387030 FAX: 0755-83376182 E-MAIL: szss20@163.com

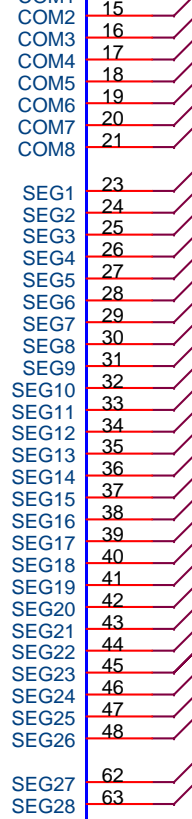
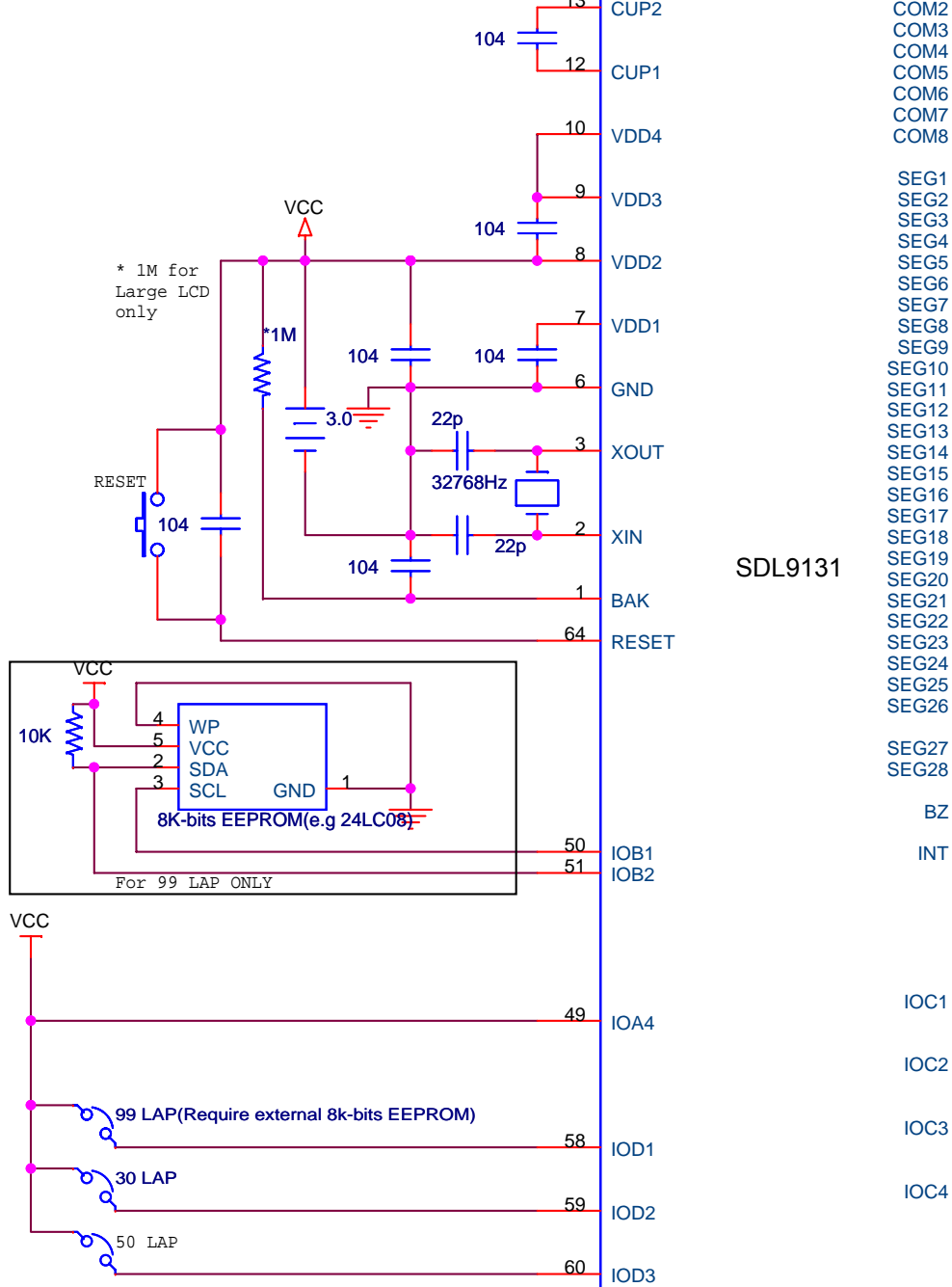

SDL9131

LCD (1/8 Duty, 1/3 Bias, Vlcd=4.5volt)

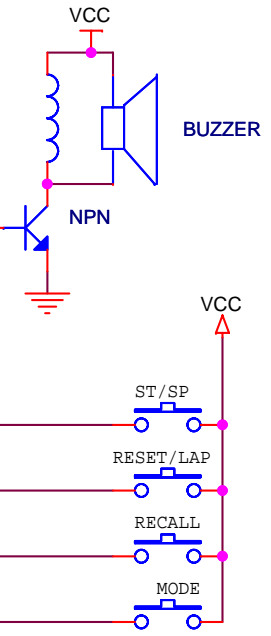

SUNSTAR单片机专用电路 <http://www.icasic.com/>

TEL: 0755-83387030 FAX: 0755-83376182 E-MAIL: szss20@163.com

Title			SDL9131		
Size	Document Number		Rev		<RevCode>
Date:	Sheet 1 of 1				