

GaAs MMIC SUB-HARMONICALLY PUMPED MIXER, 20 - 40 GHz

Typical Applications

The HMC266 is ideal for:

- 23, 26, & 38 GHz Point-to-Point Radios
- LMDS
- SATCOM

Features

- Input IP3: Up to +17 dBm
- Sub-Harmonically Pumped (x2) LO
- Small Size: 1.34 x 1.49 x 0.01 mm

Functional Diagram

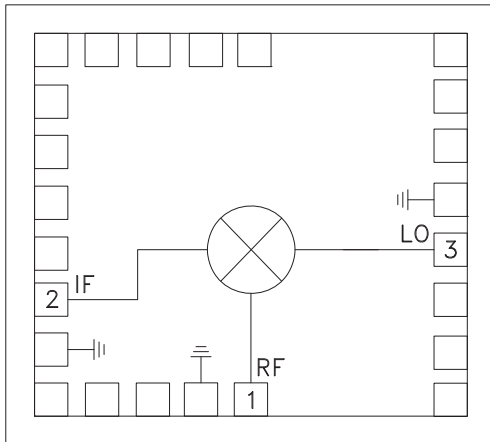

General Description

The HMC266 chip is a broadband GaAs MMIC sub-harmonically pumped (x2) balanced passive mixer which can be used as an upconverter or downconverter in a small overall chip area of 1.9 mm². The 2LO to RF isolation is excellent eliminating the need for additional filtering. All data is with the chip in a 50 ohm test fixture connected via 0.076 mm (3 mil) ribbon bonds of minimal length <0.31 mm (<12 mils). These devices are much smaller and more reliable than hybrid diode mixer designs.

Electrical Specifications, T_A = +25° C, LO Drive = +12 dBm

Parameter	IF = 1 GHz			Units
	Min.	Typ.	Max.	
Frequency Range, RF	20 - 40			GHz
Frequency Range, LO	10 - 20			GHz
Frequency Range, IF	1 - 3			GHz
Conversion Loss		12	16	dB
Noise Figure (SSB)		12	16	dB
2LO to RF Isolation	42	52		dB
LO to RF Isolation	20	24		dB
2LO to IF Isolation	50	60		dB
RF to IF Isolation	16	22		dB
LO to IF Isolation	48	55		dB
IP3 (Input)	10	13		dBm
1 dB Compression (Input)	0	+4		dBm

For price, delivery, and to place orders, please contact Hittite Microwave Corporation:

SUNSTAR 微波光电 <http://www.hittite.com> / TEL:0755-83396822 FAX:0755-83376182 E-MAIL: szss20@163.com
 Order On-line at www.hittite.com

GaAs MMIC SUB-HARMONICALLY PUMPED MIXER, 20 - 40 GHz

Conversion Gain vs. Temperature @ LO = +12 dBm

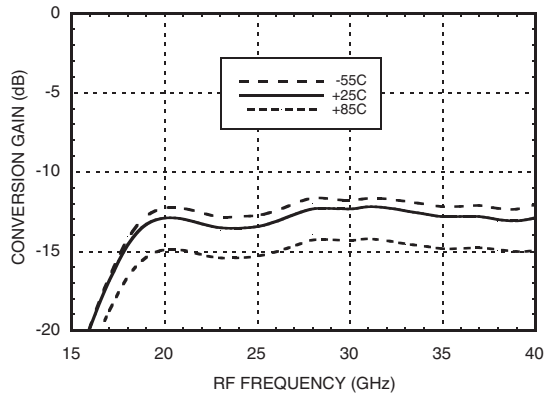

Isolation @ LO = +12 dBm

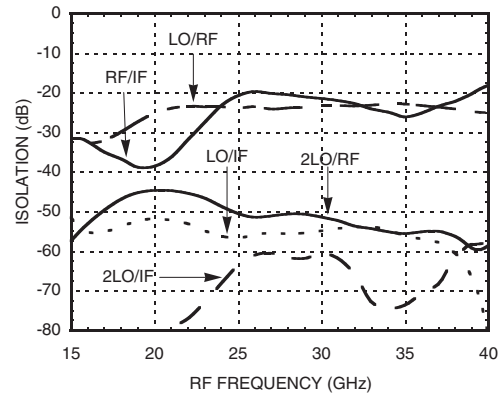

Conversion Gain vs. LO Drive

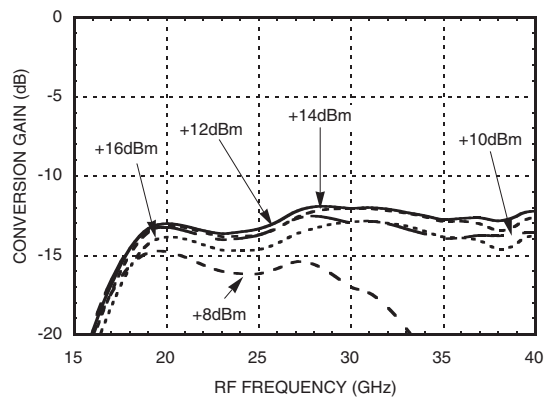

Return Loss @ LO = +12 dBm

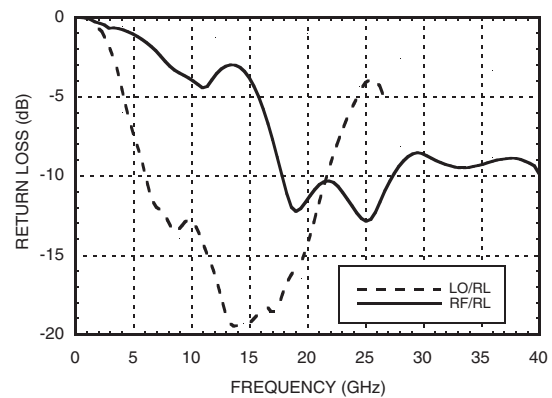

IF Bandwidth @ LO = +12 dBm

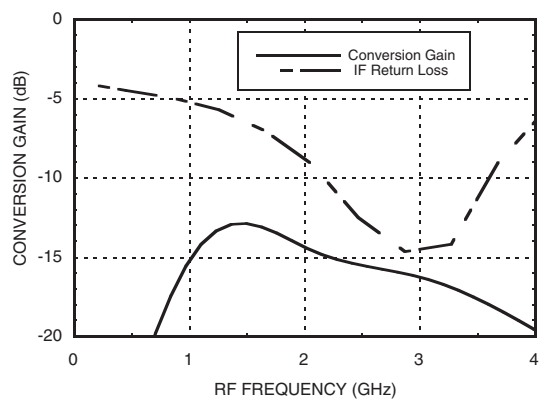

Upconverter Performance Conversion Gain @ LO = +12 dBm

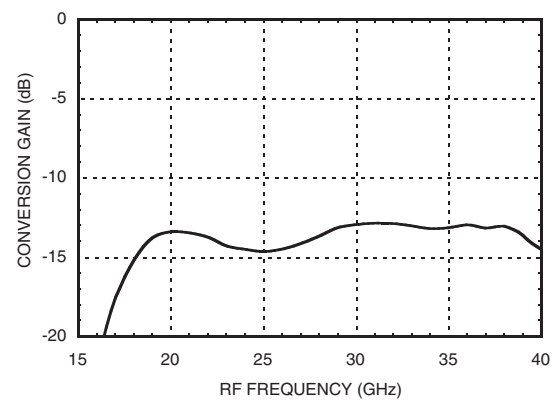

GaAs MMIC SUB-HARMONICALLY PUMPED MIXER, 20 - 40 GHz

Input IP3 vs. LO Drive

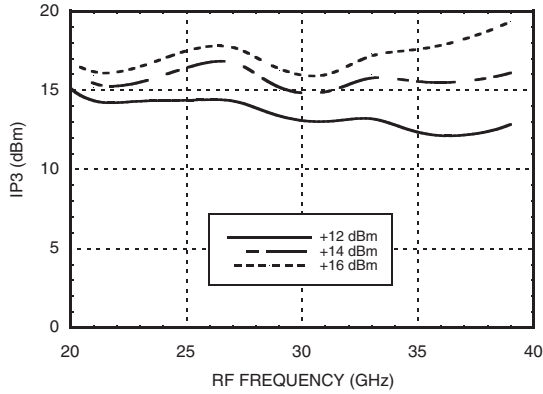

Input IP3 vs. Temperature @ LO = +12 dBm

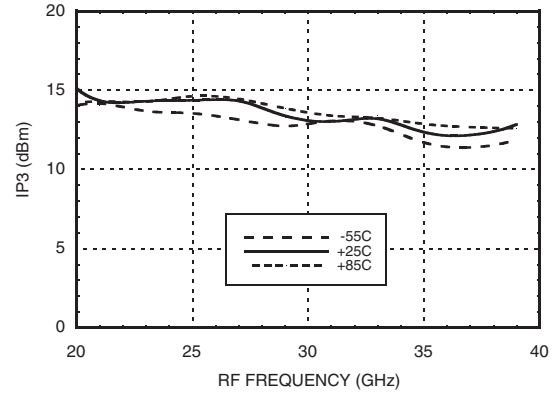

Input IP2 vs. LO Drive

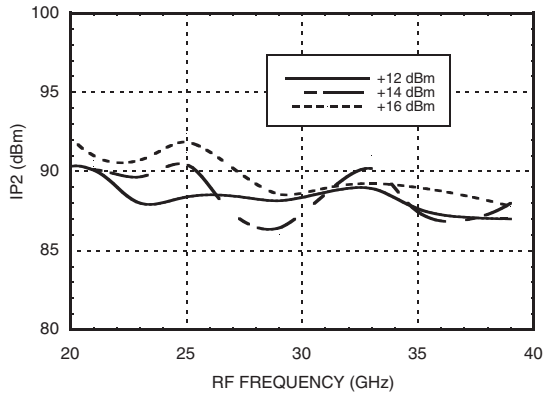

Input IP2 vs. Temperature @ LO = +12 dBm

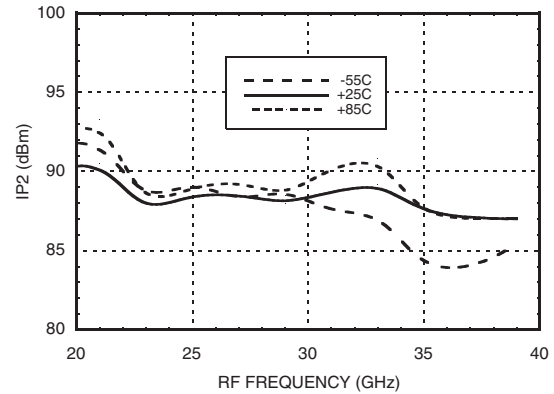

MxN Spurious Outputs as a Down Converter

mRF	nLO					
	±5	±4	±3	±2	±1	0
-3						
-2	67					
-1	50	29	70			
0			1	23	19	
1				x	63	6
2		63	79	66		
3		69				

RF = 27 GHz @ -10 dBm
 LO = 13 GHz @ +12 dBm drive level
 All values in dBc below IF power level

P1dB vs. Temperature @ LO = +12 dBm

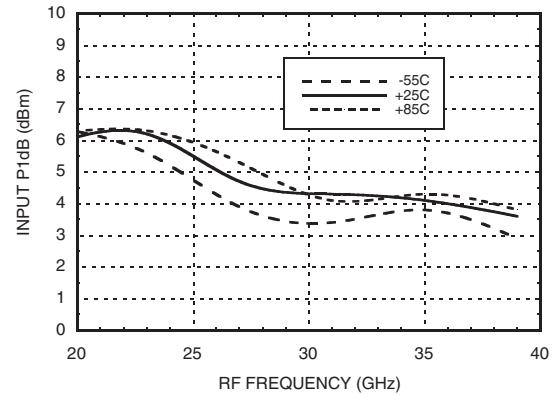

GaAs MMIC SUB-HARMONICALLY PUMPED MIXER, 20 - 40 GHz

Absolute Maximum Ratings

RF / IF Input	+13 dBm
LO Drive	+23 dBm
Storage Temperature	-65 to +150 °C
Operating Temperature	-55 to +85 °C



ELECTROSTATIC SENSITIVE DEVICE
OBSERVE HANDLING PRECAUTIONS

Outline Drawing

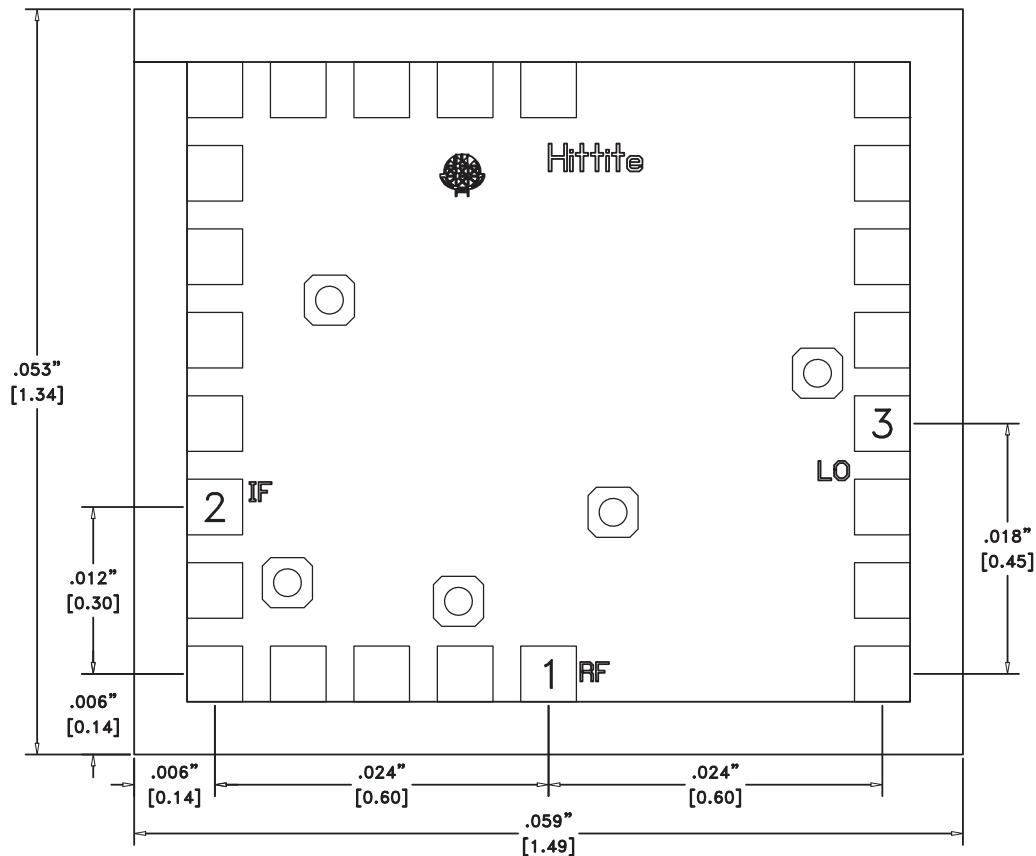

Die Packaging Information [1]

Standard	Alternate
WP-3 (Waffle Pack)	[2]

[1] Refer to the "Packaging Information" section for die packaging dimensions.



[2] For alternate packaging information contact Hittite Microwave Corporation.

NOTES:

1. ALL DIMENSIONS ARE IN INCHES [MM].
2. TYPICAL BOND PAD IS .004" SQUARE.
3. BOND PAD SPACING CENTER TO CENTER IS .006".
4. BACKSIDE METALLIZATION: GOLD.
5. BOND PAD METALLIZATION: GOLD.
6. BACKSIDE METAL IS GROUND.
7. CONNECTION NOT REQUIRED FOR UNLABELED BOND PADS.

GaAs MMIC SUB-HARMONICALLY PUMPED MIXER, 20 - 40 GHz

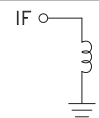
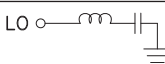
Pad Descriptions

Pad Number	Function	Description	Interface Schematic
1	RF	This pad is AC coupled and matched to 50 Ohms.	RF 
2	IF	This pad is DC coupled and matched to 50 Ohms.	IF 
3	LO	This pad is AC coupled and matched to 50 Ohms.	LO 
Die Bottom	GND	.	GND 

GaAs MMIC SUB-HARMONICALLY PUMPED MIXER, 20 - 40 GHz

Mounting & Bonding Techniques for Millimeterwave GaAs MMICs

The die should be attached directly to the ground plane eutectically or with conductive epoxy (see HMC general Handling, Mounting, Bonding Note).

50 Ohm Microstrip transmission lines on 0.127mm (5 mil) thick alumina thin film substrates are recommended for bringing RF to and from the chip (Figure 1). If 0.254mm (10 mil) thick alumina thin film substrates must be used, the die should be raised 0.150mm (6 mils) so that the surface of the die is coplanar with the surface of the substrate. One way to accomplish this is to attach the 0.102mm (4 mil) thick die to a 0.150mm (6 mil) thick molybdenum heat spreader (moly-tab) which is then attached to the ground plane (Figure 2).

Microstrip substrates should be brought as close to the die as possible in order to minimize ribbon bond length. Typical die-to-substrate spacing is 0.076mm (3 mils). Gold ribbon of 0.075 mm (3 mil) width and minimal length <0.31 mm (<12 mils) is recommended to minimize inductance on RF, LO & IF ports.

Handling Precautions

Follow these precautions to avoid permanent damage.

Storage: All bare die are placed in either Waffle or Gel based ESD protective containers, and then sealed in an ESD protective bag for shipment. Once the sealed ESD protective bag has been opened, all die should be stored in a dry nitrogen environment.

Cleanliness: Handle the chips in a clean environment. DO NOT attempt to clean the chip using liquid cleaning systems.

Static Sensitivity: Follow ESD precautions to protect against ESD strikes.

Transients: Suppress instrument and bias supply transients while bias is applied. Use shielded signal and bias cables to minimize inductive pick-up.

General Handling: Handle the chip along the edges with a vacuum collet or with a sharp pair of bent tweezers. The surface of the chip has fragile air bridges and should not be touched with vacuum collet, tweezers, or fingers.

Mounting

The chip is back-metallized and can be die mounted with AuSn eutectic preforms or with electrically conductive epoxy. The mounting surface should be clean and flat.

Eutectic Die Attach: A 80/20 gold tin preform is recommended with a work surface temperature of 255 °C and a tool temperature of 265 °C. When hot 90/10 nitrogen/hydrogen gas is applied, tool tip temperature should be 290 °C. DO NOT expose the chip to a temperature greater than 320 °C for more than 20 seconds. No more than 3 seconds of scrubbing should be required for attachment.

Epoxy Die Attach: Apply a minimum amount of epoxy to the mounting surface so that a thin epoxy fillet is observed around the perimeter of the chip once it is placed into position. Cure epoxy per the manufacturer's schedule.

Wire Bonding

RF bonds made with 0.003" x 0.0005" ribbon are recommended. These bonds should be thermosonically bonded with a force of 40-60 grams. DC bonds of 0.001" (0.025 mm) diameter, thermosonically bonded, are recommended. Ball bonds should be made with a force of 40-50 grams and wedge bonds at 18-22 grams. All bonds should be made with a nominal stage temperature of 150 °C. A minimum amount of ultrasonic energy should be applied to achieve reliable bonds. All bonds should be as short as possible, less than 12 mils (0.31 mm).

