



Typical Applications

Prescaler for DC to 18 GHz PLL Applications:

- Point-to-Point / Multi-Point Radios
- VSAT Radios
- Fiber Optic
- Test Equipment
- Military

Features

- Ultra Low SSB Phase Noise: -150 dBc/Hz
- Very Wide Bandwidth
- Output Power: -4 dBm
- Single DC Supply: +5V
- 3x3 mm QFN Package

Functional Diagram

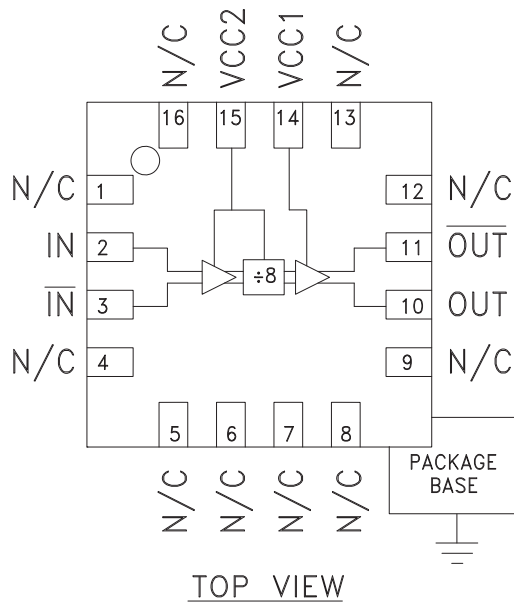

General Description

The HMC494LP3 & HMC494LP3E are low noise Divide-by-8 Static Dividers utilizing InGaP GaAs HBT technology packaged in leadless 3x3 mm QFN surface mount plastic packages. This device operates from DC (with a square wave input) to 18 GHz input frequency from a single +5V DC supply. The low additive SSB phase noise of -150 dBc/Hz at 100 kHz offset helps the user maintain excellent system noise performance.

Electrical Specifications, $T_A = +25^\circ C$, 50 Ohm System, $V_{cc} = +5V$

| Parameter | Conditions | Min. | Typ. | Max. | Units |
|--|---------------------------------------|------|------|------|--------|
| Maximum Input Frequency | | 18 | 19 | | GHz |
| Minimum Input Frequency | Sine Wave Input. [1] | | 0.2 | 0.5 | GHz |
| Input Power Range | $F_{in} = 2$ to 12 GHz | -20 | -15 | +10 | dBm |
| | $F_{in} = 12$ to 16 GHz | -20 | -15 | +3 | dBm |
| | $F_{in} = 16$ to 18 GHz | -15 | -10 | 0 | dBm |
| Output Power | $F_{in} = 0.5$ to 18 GHz | -7 | -4 | | dBm |
| Reverse Leakage | Both RF Outputs Terminated | | 55 | | dB |
| SSB Phase Noise (100 kHz offset) | $P_{in} = 0$ dBm, $F_{in} = 6$ GHz | | -150 | | dBc/Hz |
| Output Transition Time | $P_{in} = 0$ dBm, $F_{out} = 882$ MHz | | 100 | | ps |
| Supply Current ($I_{cc1} + I_{cc2}$) | | | 103 | | mA |

1. Divider will operate down to DC for square-wave input signal



Input Sensitivity Window, $T = 25\text{ }^{\circ}\text{C}$

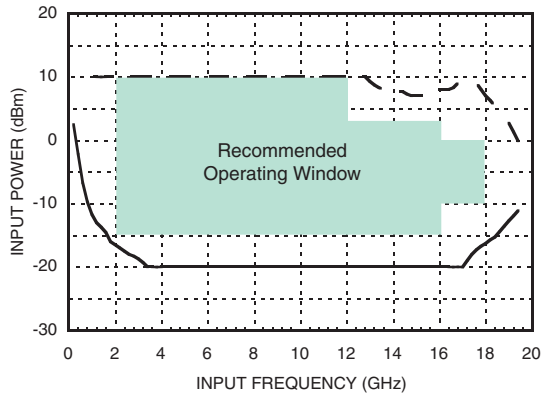

Input Sensitivity Window vs. Temperature

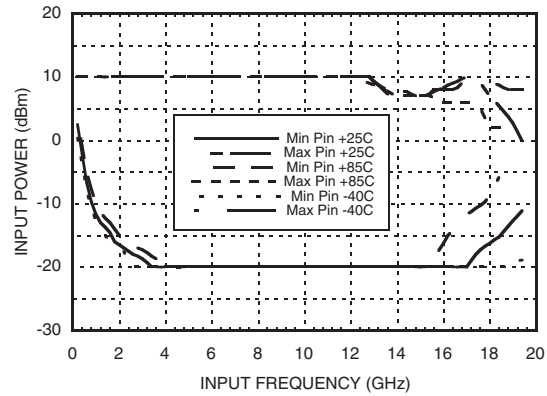

Output Power vs. Temperature

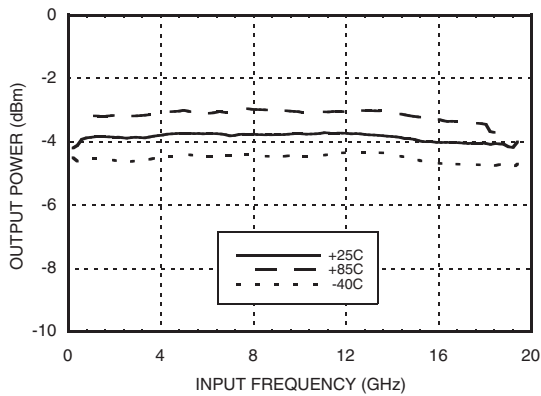

SSB Phase Noise Performance, $P_{in} = 0\text{ dBm}$, $T = 25\text{ }^{\circ}\text{C}$

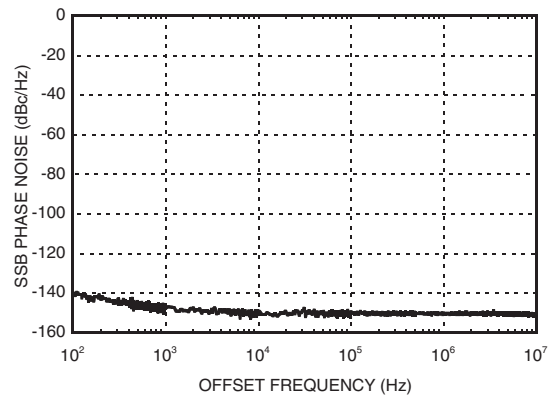

Output Harmonic Content, $P_{in} = 0\text{ dBm}$, $T = 25\text{ }^{\circ}\text{C}$

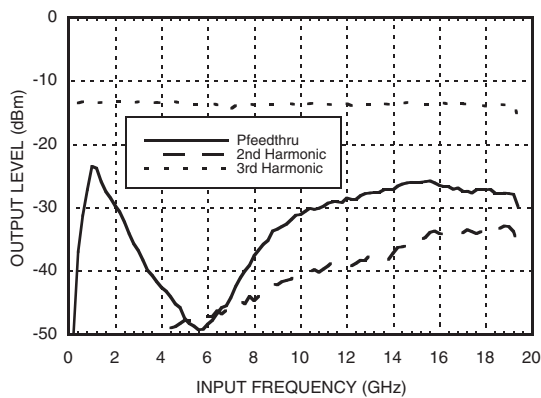

Reverse Leakage, $P_{in} = 0\text{ dBm}$, $T = 25\text{ }^{\circ}\text{C}$

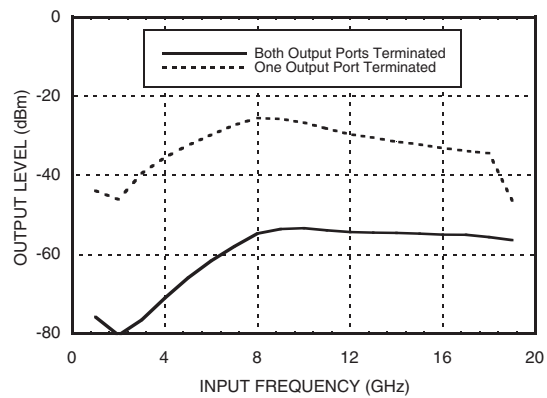



Output Voltage Waveform, Pin= 0 dBm, Fout= 882 MHz, T= 25 °C

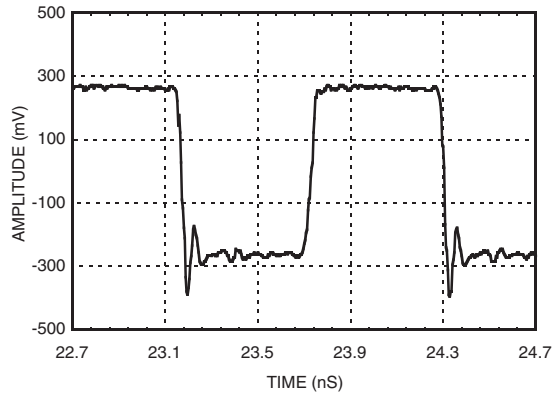

ELECTROSTATIC SENSITIVE DEVICE
OBSERVE HANDLING PRECAUTIONS

Absolute Maximum Ratings

| | |
|--|----------------|
| RF Input (Vcc = +5V) | +13 dBm |
| Supply Voltage (Vcc1, Vcc2) | +5.5V |
| Channel Temperature (Tc) | 135 °C |
| Continuous Pdiss (T = 85 °C) (derate 11.9 mW/°C above 85 °C) | 593 mW |
| Thermal Resistance (R _{TH}) (junction to ground paddle) | 84 °C/W |
| Storage Temperature | -65 to +150 °C |
| Operating Temperature | -40 to +85 °C |
| ESD Sensitivity (HBM) | Class 1A |

Typical Supply Current vs. Vcc

| Vcc1, Vcc2 (V) | Icc (mA) |
|----------------|----------|
| 4.75 | 90 |
| 5.0 | 103 |
| 5.25 | 115 |

Note: Divider will operate over full voltage range shown above

Outline Drawing

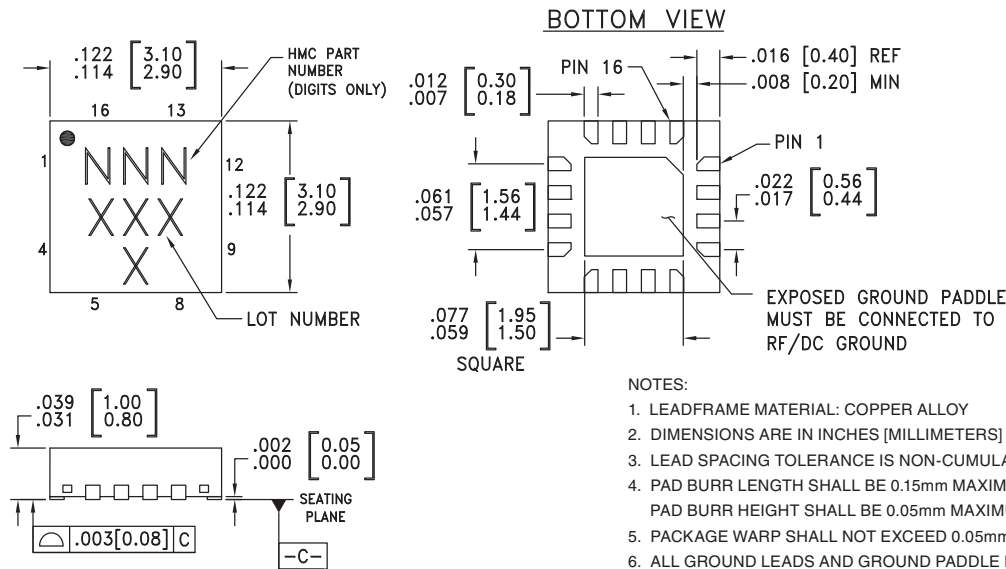

Package Information

| Part Number | Package Body Material | Lead Finish | MSL Rating | Package Marking ^[3] |
|-------------|---|---------------|---------------------|--------------------------------|
| HMC494LP3 | Low Stress Injection Molding Plastic | Sn/Pb Solder | MSL1 ^[1] | 494 XXXX |
| HMC494LP3E | RoHS-compliant Low Stress Injection Molding Plastic | 100% matte Sn | MSL1 ^[2] | 494 XXXX |

[1] Max peak reflow temperature of 235 °C

[2] Max peak reflow temperature of 260 °C

[3] 4-Digit lot number XXXX

For price, delivery, and to place orders, please contact Hittite Microwave Corporation:

SUNSTAR 微波光电 <http://www.hittite.com> / TEL:0755-83396822 FAX:0755-83376182 E-MAIL: szss20@163.com

Order On-line at www.hittite.com



Pin Description

| Pin Number | Function | Description | Interface Schematic |
|-----------------------|-------------------------|--|---------------------|
| 1, 4-9, 12, 13, 16 | N/C | No connection. | |
| 2 | $\overline{\text{IN}}$ | RF Input must be DC blocked. | |
| 3 | IN | RF Input 180° out of phase with pin 2 for differential operation. AC ground for single ended operation. | |
| 10 | OUT | Divided Output. | |
| 11 | $\overline{\text{OUT}}$ | Divided output 180° out of phase with pin 10. | |
| 14, 15 | Vcc1, Vcc2 | Supply voltage 5V ± 0.25V. Connect both pins to +5V supply. | |
| | GND | Ground: Backside of package has exposed metal ground slug which must be connected to RF/DC ground. | |

Evaluation PCB

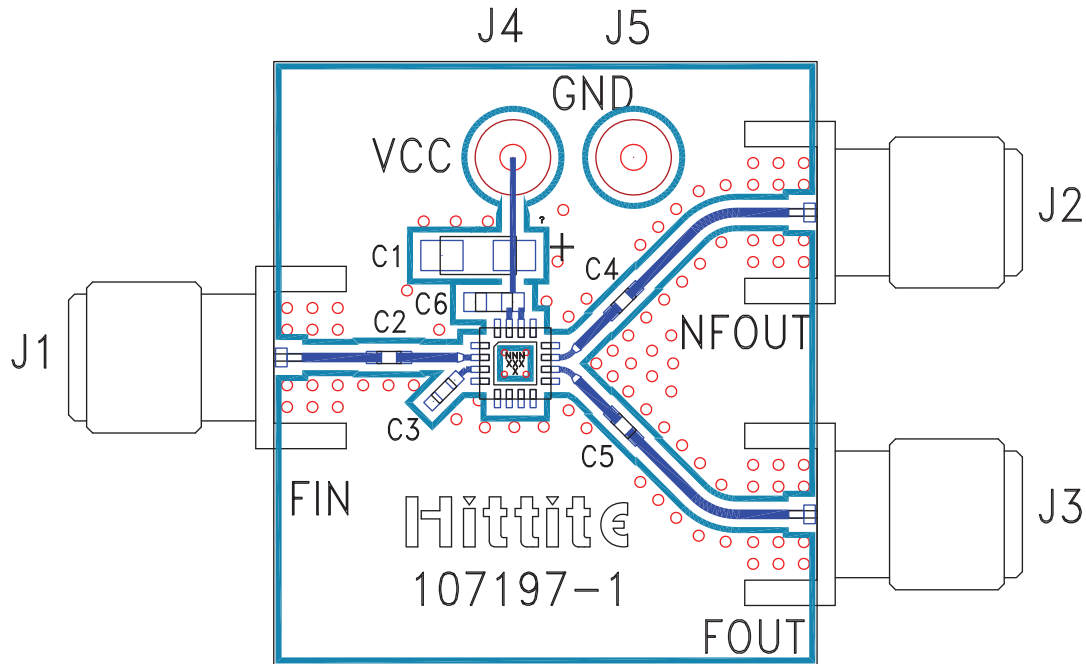

List of Materials for Evaluation PCB 107384 [1]

| Item | Description |
|---------|------------------------------------|
| J1 - J3 | PCB Mount SMA RF Connector |
| J4, J5 | DC Pin |
| C2 - C5 | 100 pF Capacitor, 0402 Pkg. |
| C6 | 1000 pF Capacitor, 0603 Pkg. |
| C1 | 2.2 uF Tantalum Capacitor |
| U1 | HMC494LP3 / HMC494LP3E Divide-by-2 |
| PCB [2] | 107197 Eval Board |

[1] Reference this number when ordering complete evaluation PCB

[2] Circuit Board Material: Rogers 4350

The circuit board used in the final application should use RF circuit design techniques. Signal lines should have 50 ohm impedance while the package ground leads and backside ground slug should be connected directly to the ground plane similar to that shown. A sufficient number of via holes should be used to connect the top and bottom ground planes. The evaluation circuit board shown is available from Hittite upon request. This evaluation board is designed for single ended input testing. J2 and J3 provide differential output signals.

For price, delivery, and to place orders, please contact Hittite Microwave Corporation:

SUNSTAR 射频通信 <http://www.hittite.com> / TEL:0755-83396822 FAX:0755-83376182 E-MAIL: szss20@163.com
Order On-line at www.hittite.com



Application Circuit

