

INTRODUCTION

SUNSTAR 单片机专用电路 <http://www.icasic.com/> TEL: 0755-83387030 FAX:0755-83376182 E-MAIL:szss20@163.com
 The DL5556 is a single CMOS LSI calculator chip with 8 digits arithmetic operations, single memory, extraction-of-square-root percentage calculation, auto power off and punctuation and touch tone function, designed for FEM LCD operation with 1.5 V power supply.

Type of substrate is P-type should be connected with GND.

FEATURES

- Accumulating memory: M+, M-, RM, CM, RM/CM.
- Rollover capability.
- Floating decimal.
- Overflow indication: E
- Automatic power off function.
- LCD direct drive.
- Bare chip available

FUNCTIONS

- Four standard functions (+, -, ×, ÷).
- Auto-constant calculations (constant: multiplicand, divisor, addend and subtrahend).
- Square and reciprocal calculations.
- Mark-up and mark-down calculations.
- Extraction of square root.
- Percentage calculations.
- Chain multiplication and division.
- Power calculations.
- Rough estimate calculations.
- Touch tone function.
- Punctuation comma display.
- Clear key: ON/C, ON/CE, CE.

ABSOLUTE MAXIMUM RATINGS

Parameter	Symbol	Value	Unit	Note
Terminal Voltage	V_{GG}	-0.3 ~ +3.0	V	1
	V_{IN}	-0.3 ~ $V_{GG}+0.3$	V	
Supply Voltage	V_{GG}	-0.3 ~ +3.0	V	
Operating Temperature	T_{OPR}	0 ~ +70	°C	
Storage Temperature	T_{STG}	-55 ~ +150	°C	

ELECTRICAL CHARACTERISTICS ($T_A=25^\circ\text{C}$, $V_{GG}=1.5\text{V}$, unless otherwise specified)

Parameter	Symbol	Test Conditions	Min	Typ	Max	Unit
Input Voltage 1	V_{IH}		$V_{GG}-0.4$			V
	V_{IL}				0.4	
Input Current 1	I_{IH}	$V_{IN} = V_{GG}$			1	μA
	I_{IL}	$V_{IN} = 0\text{V}$		5.5	10	
Output Voltage 1	V_{OH}	without load	$V_{GG}-0.15$			V
	V_{OL}	without load			0.15	
Output Voltage 2	V_{OA}	without load	2.80	2.95		V
	V_{OB}	without load	1.30	1.50	1.70	
	V_{OC}	without load		0	0.20	
Display Frequency	Fd	$V_{GG} = 1.5\text{V}$ while display is on,	40	55	70	Hz
Touch Tone Output Drive Current (Pb)	I_{OL}	$V_{GG}=1.5\text{V}$, $V_{OL}=0.5\text{V}$	0.5	1.0		mA
	I_{OH}	$V_{GG}=1.5\text{V}$, $V_{OH}=1.0\text{V}$	0.5	1.0		
Dissipation	I_{OFF}	Display off			0.1	μA
	I_{DIS}	$V_{GG} = 1.5.0\text{V}$ while display is on		6	9	
Touch Tone Output Drive-2 Current (Pbo)	I_{OL}	$V_{GG} = 1.5\text{V}$, $V_{OL} = 0.5\text{V}$	7	10		mA

LCD connector

a. Common 单片机专用电路 <http://www.icasic.com/> TEL: 0755-83387030 FAX: 0755-83376182 E-MAIL: szss20@163.com

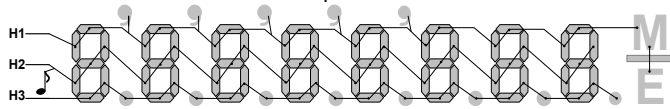

b. Segment

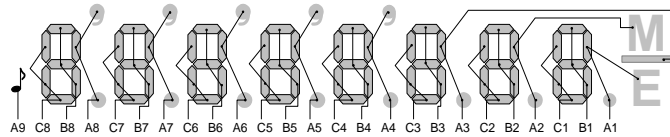

LCD Panel

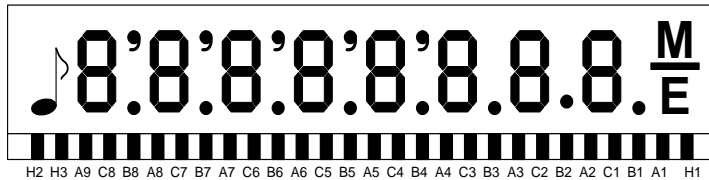

PAD DIAGRAM

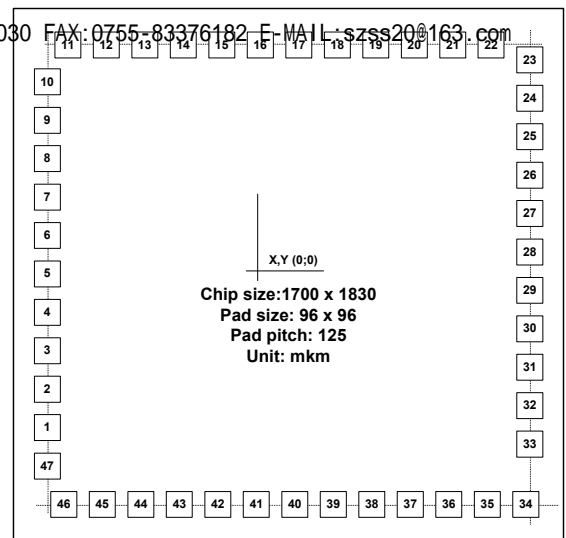

衬底接VSS

OUTPUT WAVEFORM 1; Hi

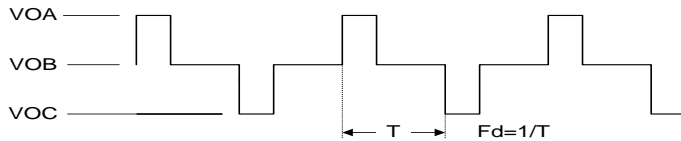

OUTPUT WAVEFORM 2; ai, bi, ci



PAD DESCRIPTION

Pad No	Signal	I/O	Description	X(μm)	Y(μm)	Pad No	Signal	I/O	Description	X(μm)	Y(μm)
1	P0	O	Piezo Output	-727	-500	25	a8	O	Display Output	727	382
2	V _{EE}		Power Supply	-727	-375	26	b8	O	Display Output	727	256
3	H1	O	Display Output	-727	-248	27	c8	O	Display Output	727	130
4	a1	O	Display Output	-727	-123	28	a9	O	Display Output	727	4
5	b1	O	Display Output	-727	4	29	H2	O	Display Output	727	-123
6	c1	O	Display Output	-727	130	30	H3	O	Display Output	727	-248
7	a2	O	Display Output	-727	256	31	GND		Ground	727	-375
8	b2	O	Display Output	-727	382	32	PB0	O	Piezo Output - 2	727	-500
9	c2	O	Display Output	-727	507	33	Va	O	Capacitor terminal for voltage set up	727	-627
10	a3	O	Display Output	-727	634	34	Vc	O	Capacitor terminal for voltage set up	727	-790
11	b3	O	Display Output	-693	790	35	T2	I	Test Input	595	-790
12	c3	O	Display Output	-567	790	36	K3	I	Key Input	483	-790
13	a4	O	Display Output	-441	790	37	K2	I	Key Input	357	-790
14	b4	O	Display Output	-315	790	38	A2	O	Strob Output	231	-790
15	c4	O	Display Output	-189	790	39	A3	O	Strob Output	105	-790
16	a5	O	Display Output	-63	790	40	A4	O	Strob Output	-21	-790
17	b5	O	Display Output	63	790	41	A5	O	Strob Output	-147	-790
18	c5	O	Display Output	189	790	42	P2	O	Strob Output	-273	-790
19	a6	O	Display Output	315	790	43	P1	O	Strob Output	-399	-790
20	b6	O	Display Output	441	790	44	K5	I	Key Input	-525	-790
21	c6	O	Display Output	567	790	45	K6	I	Key Input	-651	-790
22	a7	O	Display Output	693	790	46	T1		Test Input	-763	-790
23	b7	O	Display Output	727	634	47	K4	I	Key Input	-727	-627
24	c7	O	Display Output	727	507						

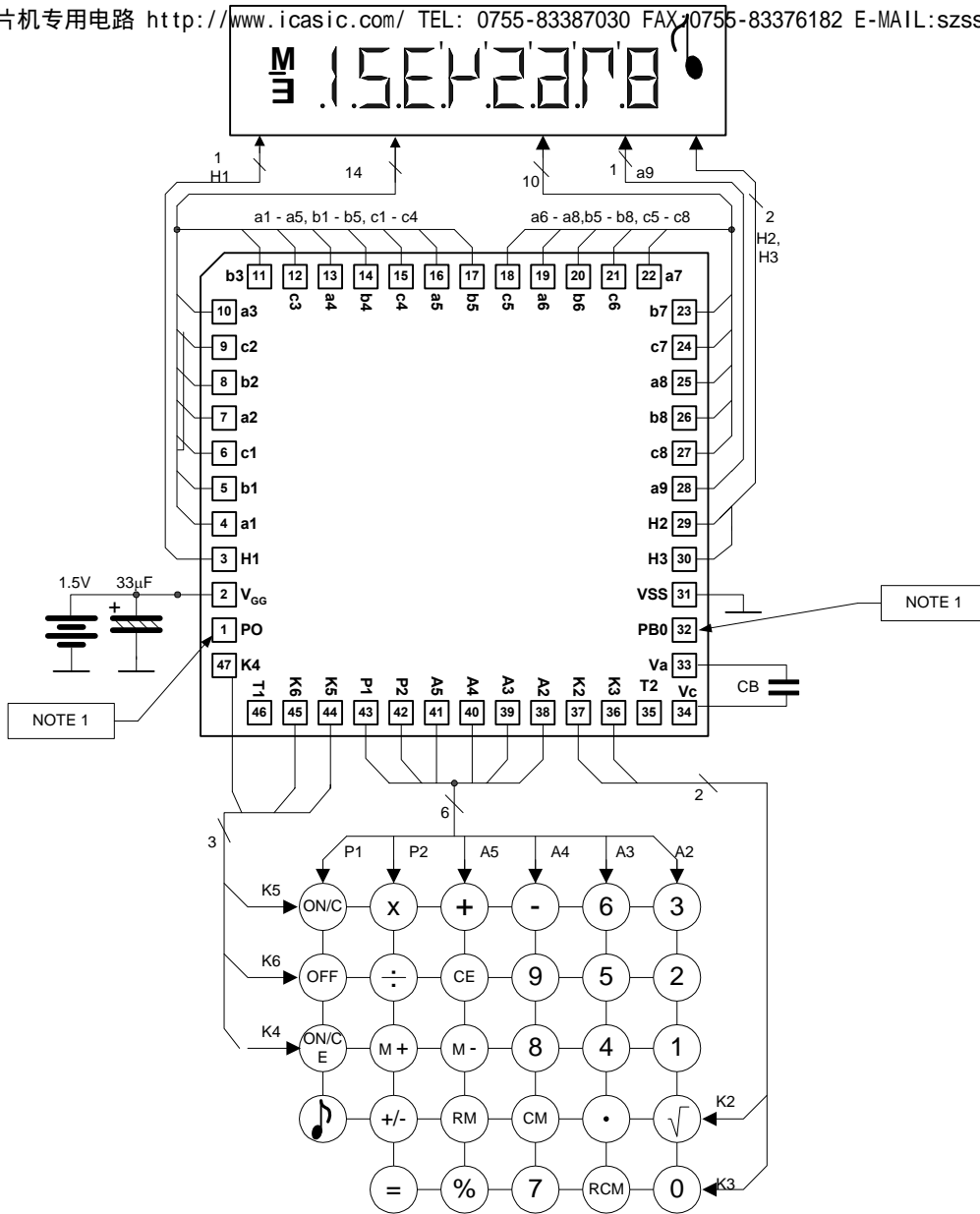

NOTE 1:TRANSDUCER DRIVE METHOD

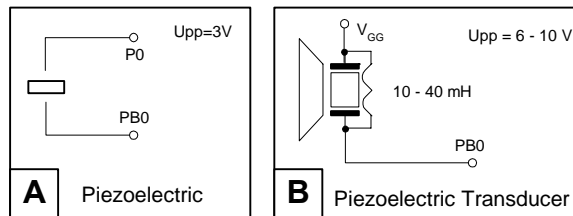

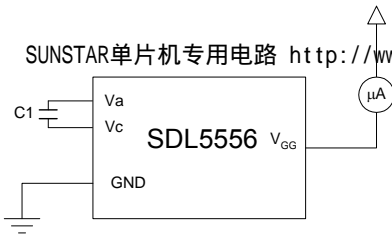

TEST CIRCUIT
C1 – 0.1μF

FUNCTIONAL DESCRIPTION

Floating point system

- 8 digits floating decimal point system, with leading zero suppression, Zero shift.
- Symbols:
 - '-' negative number indicator.
 - 'E' Error status indicator.
 - 'M' Non-zero memory indicator.
 - '|' punctuation comma
 - '♪' touch tone indicator

Error Detection's

- System errors occur when:
 - The integral part of any calculation result exceeds 8 digits.
 - The integral part of any memory calculation result exceeds 8 digits.
 - The integral part of any addend or subtrahend to memory exceed 8 digits.
 - The integral part of a mark-up or markdown calculation result exceeds 8 digits.
 - The division by zero.
 - The extraction of square root of a negative number.
- Rough estimate calculation error
 - The integral part of the result of any standard functions, percentage, square; reciprocal or power calculations result exceed 8 digits.

Error indication

- System error
'0' is indicated in the 1 digit position and 'E' in the sign indicator position.
- Rough estimate calculation error
The high-order 8 digits of a calculation result is indicated together with 'E'. The decimal point is indicated in the position corresponding to a Calculation result times 10^{-8} , and no zero shift is performed.

Error Release

- System error can be released by the ON/C or ON/CE key.
- Rough estimate calculation error can be released by the ON/C, ON/CE, CE key.

A calculation result is not cleared by ON/CE, CE key but is retained.

Number Entry

Numerical can be entered up to 8 digits, entries that equal to 9 digits or more will be ignored.

Memory Protection

The memory contents before any error detection are protected.

Memory indication

If the memory contents is non-zero, 'M' is indicated in the memory indicator position.

Double Key Depression

The order of priority when two keys are being depressed simultaneously is as follows:

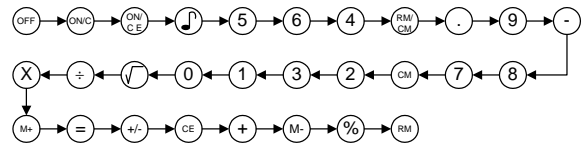

When the OFF and ON/C key are depressed simultaneously, the OFF key is given priority.

Key bounce protection

- Front edge: Minimum 3 words.
- Trailing edge: Minimum 9 words. (1 word is 6.0ms when display frequency is Fd 55Hz.)

Auto Power Off

Power automatically turns off after 7 - 10 minutes pass from the last key press.

Clear Operation

All operations except memory content are cleared by ON/C key.

Touch Tone(♪) Key

- When power is on, the touch tone function is enable and the beep sound is generated output during 125 ms and ♪ sign is displayed on LCD.

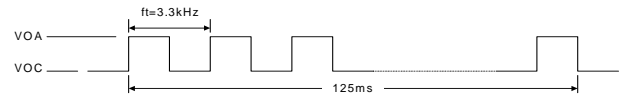

DISPLAY FONTS

a. Numerical Font

0 1 2 3 4 5 6 7 8 9

b. Sign Font

M - E , ♪

Memory indicator Negative Error indicator punctuation Touch tone indicator

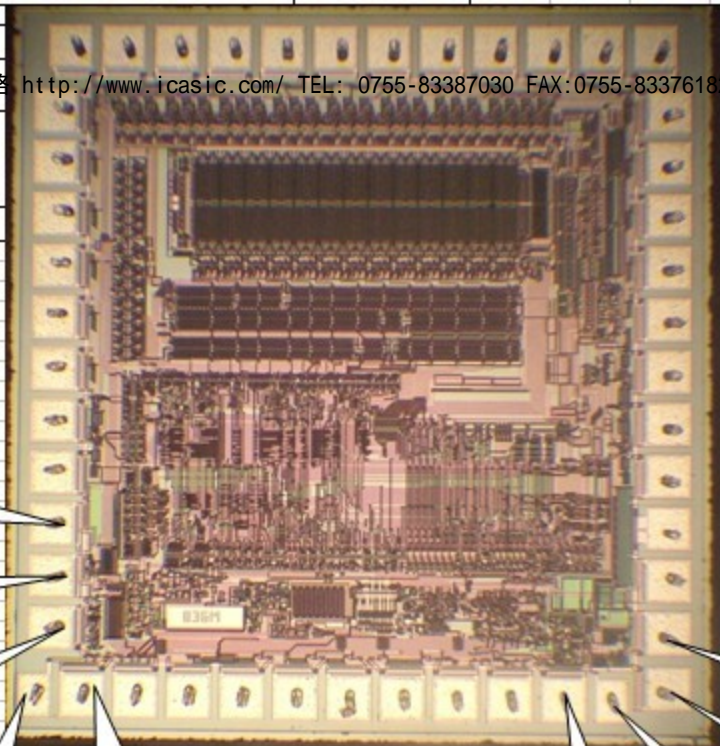

2VGG

1P0

47K4

45K6

36K3

33VA

34VB

4011空脚

3512空脚