

## TCY-BH-U Intelligent binary humidistat

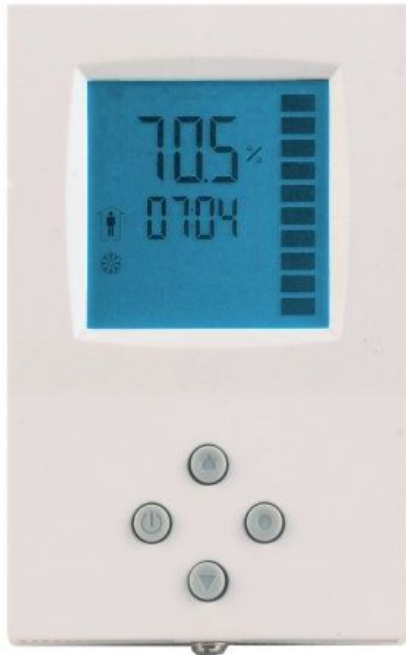

### Features

- Low power energy consumption: < 1W per unit
- Relays switching for outputs each up to 300W
- Humidity control for humidifying and de-humidifying.
- Option for fan supported devices
- Cost saving option with Economy functionality and set point limitations
- External sensor or open contact for remote control or setpoint shift based on outdoor temperature
- Control for binary humidifiers and dehumidifiers with or without fan support.
- Password protected programmable user and control parameters
  - Setpoint range limitation
  - Access control for setpoints and mode change
  - Access control for clock and time programs
  - Select your display contents
  - Selectable behavior after return from power failure
- Temperature display of external input in Celsius or Fahrenheit

### Deluxe Version:

- Clock and time schedule functions
- Blue backlight for LCD

### Applications

- Humidifiers:
  - On / Off type humidifiers
  - On / Off type humidifiers with single speed fan support
- Dehumidifiers:
  - On / Off type dehumidifiers
  - On / Off type dehumidifiers with single speed fan support
- Combination humidifiers and dehumidifiers without fan support

### General Description

The TCY-BH-U is a stand-alone electronic binary humidity stat. The TCY-BH-U features one internal humidity sensor, one external NTC temperature sensor input and two binary outputs (Relays).

A detailed parameterization is possible with the use of a simple configuration routine. The TCY-BH-U can be configured using the standard operation terminal. No special tools or software is required.

### Ordering

Item Name	Item code	Variant	Features
TCY-BH-U	40-10 0055	standard	Binary controller with: 1 Internal humidity input 1 external temperature input (For set point shift) 1 DO (Relay) for humidifier or dehumidifier 1 DO (Relay) for fan (optional)
TCY-BH-U-W04	40-10 0055-01	humidifying	
TCY-BH-U-W05	40-10 0055-02	de-humidifying	
TCY-BH-U-D	40-10 0056	Deluxe	Binary controller with: 1 Internal humidity input 1 external temperature input (For set point shift) 1 DO (Relay) for humidifier or dehumidifier 1 DO (Relay) for fan (optional)
TCY-BH-U-D-W04	40-10 0056-01	humidifying	
TCY-BH-U-D-W05	40-10 0056-02	de-humidifying	

### Accessories

Item Name	Item code	Variant	Features
S-Tn10-2	40-20 0001		Flying lead sensor with 2 m cable
SD-Tn10-12-2	40-20 0002		Flying lead duct sensor 12cm immersion depth, 2m cable
SD-Tn10-20-2	40-20 0003		Flying lead duct sensor 20cm immersion depth, 2m cable
SDB-Tn10-12	40-20 0051		Duct sensor with housing, 12cm immersion depth
SDB-Tn10-20	40-20 0004		Duct sensor with housing, 20cm immersion depth
SOA-Tn10	40-20 0006		Outdoor sensor

### Selection of devices and sensors

External temperature sensors: Use only our approved NTC sensors to achieve maximum accuracy. Recommended is SDB-Tn10-15 as Duct sensor and SOA-Tn10 as outdoor sensor.

Binary auxiliary devices: E.g. humidifiers, de-humidifiers and fans. Do not directly connect devices that exceed 2(1.2)A. Observe startup current on inductive loads!

### Technical Specification

Power Supply	Operating Voltage	24 V AC/DC $\pm$ 10 %, 50...60 Hz
	Power Consumption	Max. 1.5 VA
	Electrical Connection	Terminal Connectors, wire 0.34...2.5 mm <sup>2</sup> (AWG 24...12)
	Internal rectification: Signal ground = power ground	Half wave rectified Isolation transformer required
	Deluxe type only: Power backup for real time clock	Min 48h if charged for 24h
Signal Inputs	Humidity Input: Range Accuracy  Hysteresis	Element: Polymer-Based Capacity Sensor 0...100 % r.H. 10%...90% r.H. $\pm$ 5.0 % 0...10% and 90...100% $\pm$ 7.0 % $\pm$ 1% r.H.
	Temperature Input Range Accuracy	External NTC (Sxx-Tn10 sensor): -40...70 °C (-40...158 °F) -40...0 °C (-40...32 °F): 0.5 K 0...50 °C (32...122 °F): 0.2 K 50...70 °C (122...158 °F): 0.5 K
Signal Outputs	Digital Switching Outputs Switching type AC Switching power	DO1...DO2 Relays 2(1.2) A, 250VAC (max fan power 300W)
Environment	Operation Climatic Conditions Temperature Humidity	To IEC 721-3-3 class 3 K5 0°C ...50°C (32°F...122°F) <95% R.H. non-condensing
	Transport & Storage Climatic Conditions Temperature Humidity Mechanical Conditions	To IEC 721-3-2 and IEC 721-3-1 class 3 K3 and class 1 K3 -25°C...70°C (-13°F...158°F) <95% R.H. non-condensing class 2M2
Standards	 conform according to EMC Standard 89/336/EEC EMEI Standard 73/23/EEC	EN 61 000-6-1/ EN 61 000-6-3
	Product standards Automatic electrical controls for household and similar use Special requirement on humidity dependent controls	EN 60 730 -1  EN 60 730 - 2 - 9
	Degree of Protection	IP30 to EN 60 529
	Safety Class	III (IEC 60536)
Housing	Cover, back part Mounting Plate	Fire proof ABS plastic (UL94 class V-0) Galvanized Steel
General	Dimensions (H x W x D) Front part: Power case:	112 x 73 x 15 mm (4.4" x 2.9" x 0.6") $\varnothing$ 58 x 32 mm ( $\varnothing$ 2.3" x 1.3")
	Weight (including package)	270g

### Dimensions

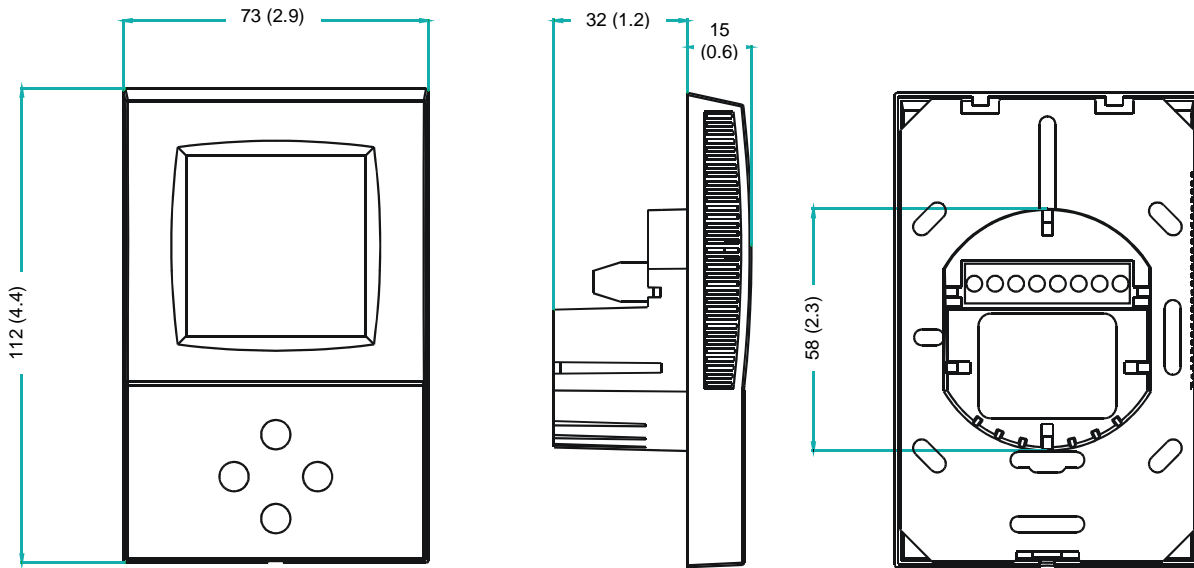

### Wiring Diagram

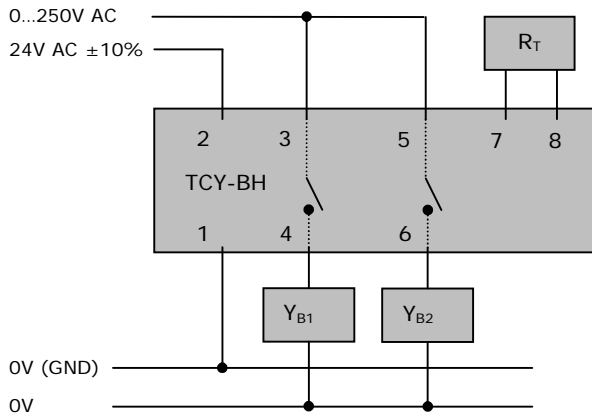

#### Description:

Y <sub>B1</sub>	Binary output 1: Humidify or Fan	0...250 VAC or 0...30 VDC
Y <sub>B2</sub>	Binary output 2: De-humidify or fan	0...250 VAC or 0...30 VDC
R <sub>T</sub>	Temperature input for setback:	NTC 10kΩ @ 25°C (77°F)



## WARNING:

Power supply is half-wave rectified:  
Signal ground = Power ground

Connect through a safety isolation transformer

## Connection terminals

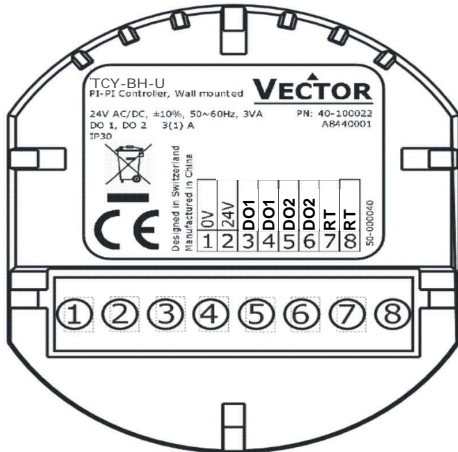

### Terminal-description:

1. Connection for power-supply (24 V AC/DC,  $\pm 10\%$ ). In case of DC, connect the negative power-terminal. Common connection for analog in- and outputs.
2. Connection for power-supply (24 V AC/DC,  $\pm 10\%$ ). In case of DC, connect the positive power-terminal
3. Switched contact "DO 1" Humidify or Fan (Max. 2 (1.2A))
4. Switched contact "DO 1" Humidify or Fan (Max. 2 (1.2A))
5. Switched contact "DO 2" Dehumidify or Fan (Max. 2 (1.2A))
6. Switched contact "DO 2" Dehumidify or Fan (Max. 2 (1.2A))
7. Thermistor input "RT" (Thermistor Sxx-Tn10)
8. Thermistor input "RT" (Thermistor Sxx-Tn10)

## Mechanical Design and installation

The unit consists of two parts: (a) The power case with attached mounting plate and (b) the front part.

### Mounting location

- On an easy accessible interior wall, approx. 1.5 m (4.5') above the floor in an area of average temperature.
- Avoid exposure to direct sunlight or other heat sources, e.g. the area above radiators and heat emitting electrical equipment.
- Avoid locations behind doors, outside walls and below or above air discharge grills and diffusers.
- Location of mounting is less critical if external temperature sensors are used



### Installation





1. Connect the wires to be connected to the terminals of the power case according to wiring diagram
2. Install the mounting plate to the flush mounting box. Make sure that the nipple with the front retaining screw is at the bottom. Make sure the mounting screw heads do not stand out more than 5 mm (0.2") from the surface of the mounting plate.
3. Ensure that the jumpers are set correctly.
4. Slide the two latches located on the top of the front part into the hooks at the upper side of the mounting plate.
5. Carefully lower the front part until the interconnector reaches the mounting-plate. Continue pressing in a gentle way until the front part is fully connected. While inserting the connectors, a slight resistance can be felt. This is normal. Do not use excessive force!
6. With a Philips-type screw driver of size #2, carefully tighten the front holding screw to secure the front part to the mounting plate. This screw is located on the front lower side of the unit. There is no need to tighten the screw too much.

## Display and Operation



The operation terminal uses an LCD display and four operation buttons.

Legend:

1. 4-digit display of current value, time, control parameter or set point.
2. Unit of displayed value, °C, °F, % or none
3. Indication of active binary stage, running down to up = humidifying, running up to down = de-humidifying
4. 4-digit display of current value, time, control parameter or set point.
5. Operation modes:  Comfort mode,  Economy mode, OFF Energy Hold Off
6. Symbols:

Setback Active	Schedule Set	Fan Active	TSET Error
			

7. Buttons for operating the controller

-  POWER button: Pressing the button less than 2 sec toggles Economy and comfort modes. Pressing the button for more than 2 seconds switches the unit off.
-  UP and DOWN buttons: change setpoints and parameters
-  OPTION button: display temperature if temperature setback is enabled and access advanced setup.

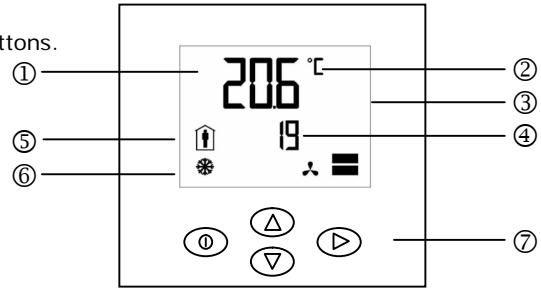

## Power Failure

All the parameters and set points are memorized and don't need to be reentered. Depending on UP-05 the unit will remain switched off, switch on automatically or return to the operation mode it was in before the power failure. The deluxe version includes a real time clock with a 48h backup battery powered through a super capacitor. The time does not need to be re-entered after a power failure.

## Operation Modes

- Comfort: The unit is in full operation mode. All the control functions are operating according to their setpoints. The unit displays occupied mode.
- Economy: The set point is shifted according to parameters FC-04. The heating parameter is shifted down and cooling parameter up. The unit displays unoccupied mode Economy operation may be disabled with UP-06.
- Off mode: The unit is switched off. All outputs are off. Off and current time is displayed.

## Activation of operation modes

- Via operation terminal
- Clock: (Deluxe version only) Operation modes may automatically be switched according to time of day and weekday. The clock symbol will be displayed if time programs are activated.

Note: Time programs will not operate if operation mode is set to OFF by remote control, or if time is not set.

### Clock Operation and Time Schedules (Deluxe Version)

TCY-BH-U-D contains a real time clock. Up to 16 mode changes (not defined, Off, Economy, Comfort, University mode) based on weekdays and time may be programmed. See chapter operation on how to program switch times.

The different scheduled mode changes have these effects:

Name on display	Function	Override reset
no	Switching event not used	
OFF	Operation mode changes to off mode	Reset is active
ECO	Operation mode changes to economy mode	Reset is not active
ON	Operation mode changes to comfort mode	Reset is not active
UNI	Operation mode does not change	Reset is not active

UNI: University mode: This switching mode is used for rooms such as lecture rooms and auditoriums that might be occupied during a certain time. During this time the reset is not active. The unit will not start itself when UNI mode is active. It still needs to be manually activated. This is to avoid unnecessary heating or cooling of such rooms while they are not occupied.

Override reset function: The override reset applies when the unit is manually switched on, while in scheduled off mode. The unit will switch automatically off when the reset time defined in UP-13 expires. Setting UP-13 to 0 disables the override reset.

A blinking clock indicates that the time needs to be set. Time programs will not operate if the time is not defined. See chapter operation, advanced settings for instructions on how to set the time.

### Error messages

The TCY-BH-U may display the following error condition:

- Err1: Humidity sensor faulty. The humidity sensor is damaged.
- Err2: External input for temperature setback missing or damaged.

## Operation of the Terminal Unit

### Switching ON

The unit is switched on by pressing the POWER button. It will start up in comfort mode.

### Changing between COMFORT and ECONOMY

Pressing the POWER button for less than 2 seconds toggles between ECONOMY and COMFORT modes. Economy mode may be disabled with UP-06.

### Switching OFF

Pressing the POWER button for more than 2 seconds, will switch the unit off. OFF and current time will be displayed in the LCD.

### Standard display

This display mode is active if no UP/DOWN or OPTION button has been pressed during the previous 30 seconds. The contents of the large and small digits may be chosen with parameters UP-10 and UP-11.

Pressing UP/DOWN button will show the humidity setpoint in the small digits and room humidity in the large digits.

### Changing of set points

Press UP/DOWN buttons to change humidity setpoint. Changing of set points may be disabled with UP-01.

### Showing the external temperature sensor

If temperature setback is enabled, the measured external temperature can be seen by pressing the OPTION button for less than 3 seconds.

## Accessing advanced settings

Pressing the option button for more than three seconds will start the advanced setup menu. The basic version will only show heat/cool setup. The deluxe version will allow access to the time setting function.

The large LCD digits display SEL. The advanced setup menu accesses these settings: CALH, CAL t, Clock setup, Time schedule. The menu may be left by pressing the POWER button or by not pressing a button for more than 5 minutes.

### Clock Setup and Time Schedule (only available on Deluxe versions)

- Calibration of inputs: SEL is displayed in the large digits and CALH or CAL t in the small. Pressing OPTION will reveal the current calibration value of the humidity sensor (CALH) or the temperature input (CAL t). Change the value with the UP/DOWN keys and confirm with OPTION key.
- Clock Setup: The current time is displayed in the small digits. Pressing the OPTION button will enter the clock setup. The minutes are blinking and may be changed with the UP/DOWN buttons. Pressing OPTION saves the minutes and steps to the hours. The hours are blinking. Pressing the OPTION button again will step to the weekday. DAY1-7 is displayed. Day 1 stands for the first working day (Monday) of a 5-day working week. (See schedule). Select the day according to current weekday. Pressing Option again saves the settings and moves back to the SELECT menu.
- Time Schedules: press the option button while Pro is displayed in the small digits. Pro1 is now shown in the large digits, while the number 1 is blinking. Select time program by using UP/DOWN buttons. There are a total of 4 time programs with each 4 switching times available. Enter the time program by pressing the OPTION button.
  1. Activate or deactivate the time program. Choose ON or OFF with the UP/DOWN buttons
  2. Select weekday(s) = d1-7, d1-5, d6-7, day1, day2, day3, day4, day5, day6, day7The next steps define the switching mode and time. The bar indicator on the right side shows programming progress. There are four switch times for each program.
  3. Select desired operation mode. (no, OFF, ECO, ON, UNI), press OPTION to continue
    - no = disables this switching time
    - OFF = switches unit Off, enables reset timer
    - ECO = sets operation mode to On and Economy, disables reset timer
    - ON = sets operation mode to On and Comfort, disables reset timer
    - UNI = Does not change operation mode, only disables reset timer
  4. Select switching time 00:00 to 23:45 in 15-minute steps; press OPTION to continue.
  5. Repeat steps 3 and 4 for each switching time.

Access to time schedules may be disabled with UP-04

## Setting of user parameters

The TCY-BH-U can be adapted to fit perfectly into your application. The control operation is defined by parameters. The parameters are set during operation by using the control buttons.

The parameters may only be accessed by entering a code. There are two levels of parameters: User operation parameters for access control settings, and Expert parameters for control functions and unit setup. The codes for user levels and expert levels are different. Only control experts should be given the control parameter code.

The parameters can be changed as follows:

1. Press UP and DOWN button simultaneously for three seconds. The display shows the software version in the large digits and the product code in the small digits.
2. Pressing the OPTION button will indicate CODE on the small digits and 000 on the large digits.
3. The code for accessing the user parameters is 009
4. Select this using UP or DOWN buttons.
5. Press OPTION button after selecting the correct code.
6. Once logged in, the parameter is displayed immediately.
7. Select the parameters with the UP/DOWN buttons. Change a parameter by pressing the OPTION button. Three triangles will show up on the lower right and indicate that the parameter may be modified now. Use UP or DOWN buttons to adjust the value.
8. After you are done, press OPTION or POWER in order to return to the parameter selection level.
9. Press the POWER button again so as to leave the menu. The unit will return to normal operation if no button is pressed for more than 5 minutes.

### User Parameters

Parameter	Description	Setting Range	Factory Setting
UP 00	Enable change of operation modes	ON, OFF	ON (Enabled)
UP 01	Enable change of setpoints	ON, OFF	ON (Enabled)
UP 02	Enable access to Time programs	ON, OFF	ON (Enabled)
UP 03	State after power failure: 0 = Switched OFF, 1 = Switched ON, 2 = state before power failure	0, 1, 2	2
UP 04	Enable Economy functionality	ON, OFF	OFF (Disabled)
UP 05	Celsius or Fahrenheit, Select ON for Fahrenheit, OFF for Celsius	ON, OFF	OFF (Celsius)
UP 06	Select contents of small digits in standard mode: 00 = OFF 01 = Setpoint 02 = Humidity Sensor 03 = External Temperature Sensor 04 = Clock	0...5	04 Deluxe: show clock 01 Standard: show setpoint
UP 07 Deluxe only	Clock display type: OFF = Show 24hour clock ON = Show 12hour clock (AM, PM)	ON, OFF	OFF (24h)
UP 08 Deluxe only	Reset timer for override mode: Only available for deluxe version 0 = Reset of override mode is not active. 1...255 = delay in minutes to switch off device if ON/Economy mode is activated while the unit is scheduled to be in OFF mode	0...255	60 (Min)



## Control Functions

The controller is designed to control binary heating and/or cooling systems.

### Setpoint

Minimum and Maximum Set Point Limits: Limits the adjustable range of the loop set point. The limits for heating and cooling sequence may be chosen individually.

### Control Sequence

Economy set point shift  $X_{SBY}$ : This function shifts the set point while the operation mode is Economy. The heating set point  $W_H$  is reduced and the cooling set point  $W_C$  increased by the value of the Economy set point shift  $X_{SBY}$ .

Dead Zone Span  $X_{DZ}$ : The dead zone span lies between the humidifying and the de-humidifying set point.

Switching Hysteresis: Defines the difference between switching on and switching off an output. A small hysteresis will increase the number of switching cycles and thus the wear on associated equipment.

Delay OFF: Prevents a too short running cycle for the control output by setting a minimum running time.

Delay ON: Prevents a too short stopping cycle for the control output by setting a minimum stopping time.

### Binary Control

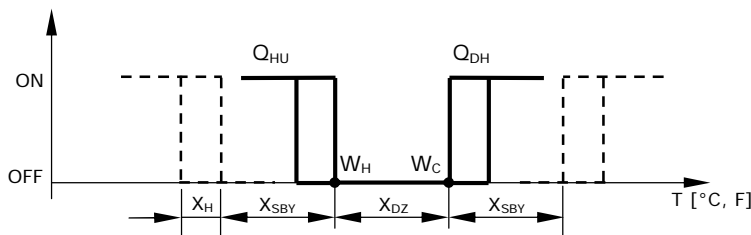

T	Room Humidity	$W_{HU}$	Setpoint Humidifying Mode	$D_Z$	Dead Zone
$W_{DH}$	Setpoint De-humidifying Mode	$X_{SBY}$	Economy Shift	$X_H$	Hysteresis
$Q_{HU}$	Humidifying Output	$Q_{DH}$	De-humidifying Output		

### Temperature setback (TSET)

Shift the humidity set point towards a defined TSET setpoint CP 15 depending on the outdoor temperature.

Temperature setback becomes active when the outside temperature drops below the activation limit of temperature setback CP17. The full temperature setback is reached when the temperature reaches the full limit CP16. The actual set point will in this case be equal to the TSET setpoint.

Temperature setback may be enabled with CP14.

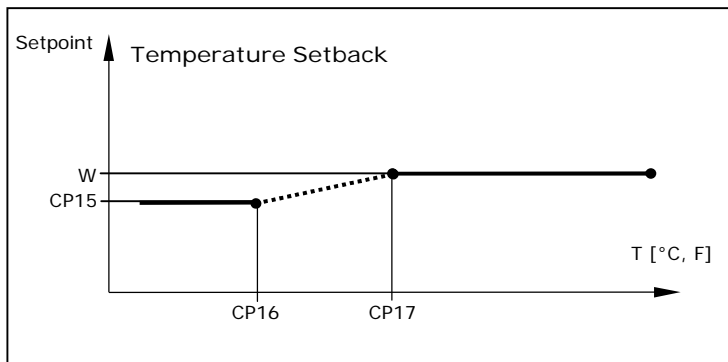

## Output Configuration

Two devices may be controlled. CP10 decides if control mode is humidify or dehumidify modes are enabled. In case dual control mode is disabled CP11 activates fan control on the available output.

### Control Logic TCY-BH

System type	CP10	CP11	DO1	DO2
Humidify and de-humidify	0	OFF	Humidifying	Dehumidifying
Humidify only	1	OFF	Humidifying	OFF
Humidify with fan	1	ON	Humidifying	FAN
De-humidify only	2	OFF	OFF	Dehumidifying
De-humidify with fan	2	ON	FAN	Dehumidifying

### Fan delay

The fan output may be activated with parameter CP11. CP10 must be  $\neq 0$  for the fan output to function.

Once there is an output demand, the humidistat will first activate the fan, wait the required start delay time (CP12) and then activate the control output. This will ensure stable air for humidification or de-humidification.

The control output will be switched off when the setpoint is reached. The fan keeps running until stop delay (CP13) has expired. This will ensure that no left over humidity remains in the humidify- / de-humidify device or its ducts.

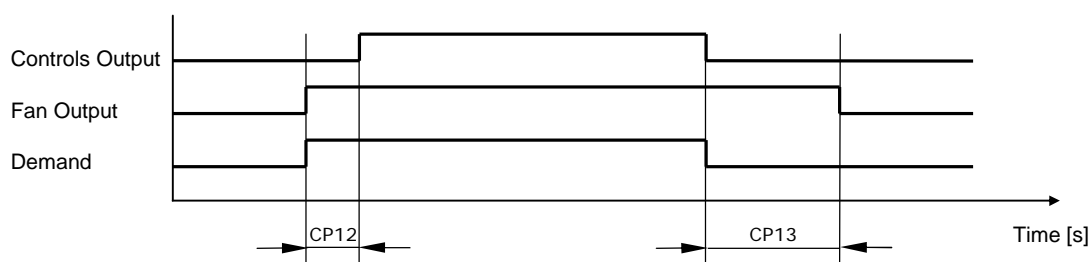

## Configuration parameters for firmware version 1.0

The TCY-BH-U can be adapted to wide variety of applications. The adaptation is done with parameters. The parameters can be changed on the unit without the need of additional equipment.

### Identifying the firmware version

The parameters and functionality of controller depend on its firmware revision. It is therefore important to use a matching product version and parameter set. The firmware version is shown on the large LCD digits when pressing UP and DOWN buttons for more than 3 seconds simultaneously.

### Control Parameters (Access Code: 241)

Warning! Only experts should change these settings! See user parameters for login procedure.

Parameter	Description	Range	Standard
CP 00	Minimum setpoint limit in humidification mode	0...100%	10%
CP 01	Maximum setpoint limit in humidification mode	0...100%	90%
CP 02	Minimum setpoint limit in de-humidification mode	0...100%	10%
CP 03	Maximum setpoint limit in de-humidification mode	0...100%	90%

#### Controls configuration

CP 04	Economy humidity shift	0...100%	10%
CP 05	Dead zone between humidifying & de-humidifying set point $X_{DZ}$	0...100%	10%
CP 06	Delay on humidify – de-humidify change over	0...255 min	5 min
CP 07	Switching Hysteresis	0...100%	3%
CP 08	Delay OFF (Minimum running time)	0...255s	10s
CP 09	Delay ON (Minimum stopping time)	0...255s	10s
CP 10	Configuration of control mode 0 = Both Humidification and de-humidification 1 = W04 = Humidification only 2 = W05 = De-humidification only	0 - 2	TCY-BH: 0 TCY-BH-W4: 1 TCY-BH-W5: 2

#### Output configuration

CP 11	Enable fan (only if CP 10 ≠ 0)	ON, OFF	TCY-BH: OFF TCY-BH-W4: ON TCY-BH-W5: ON
CP 12	Start delay for fan (Time the fan runs before control output starts)	0...255 s	10 s
CP 13	Stop delay for fan (Time the fan keeps running after control output stops)	0...255 s	90 s

#### Temperature setback configuration

CP 14	Enable temperature setback OFF = Temperature setback is disabled ON = Temperature setback is enabled	ON, OFF	OFF
CP 15	Setpoint limit at full setback	0...100%	20%
CP 16	Lower temperature limit: Outside temperature with maximum setback The setpoint will be equal to the minimum setpoint limit	-40...60°C -40...160°F	-30°C (-22°F)
CP 17	Upper temperature limit: Outside temperature at begin of setback.	-40...60°C 40...160°F	0°C (32°F)