

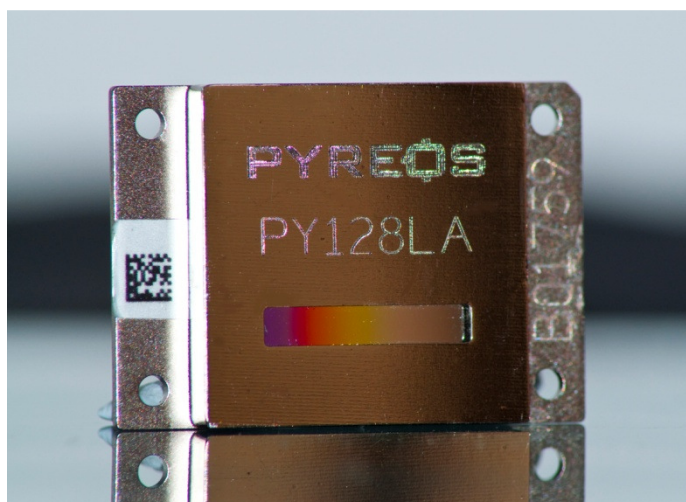

# Portable IR Spectrometer Demonstration Unit



Introducing Transmission and ATR (Attenuated Total Reflection)  
demonstration spectrometers based on Pyreos linear line array  
sensors

For low cost, robust, mid or near IR spectroscopy applications

## User Guide

Version 1.2  
July 2011



# 1 Table of contents

2	Introduction .....	2
2.1	Linear Variable Filters (LVF) .....	3
2.2	ATR Spectrometer .....	4
2.3	Transmission Spectrometer .....	5
2.3.1	Example measurement.....	6
3	Kit Contents .....	7
4	Quick Start .....	8
5	Using your spectrometer .....	9
5.1	Placing specimens on your ATR spectrometer .....	9
5.2	Cleaning and care of the ATR crystal .....	9
5.3	Placing the transmission cell into the transmission mode spectrometer .....	10
6	Software user guide .....	11
6.1	Spectrometer connection status.....	13
6.2	Live data view .....	13
6.3	Number of samples.....	13
6.4	Capture buttons .....	14
6.5	Live transmittance graph.....	16
6.6	Spectrum title .....	16
6.7	Current background details.....	16
6.8	Properties dialogue box .....	16
6.9	Details of the file to which readings are saved .....	18
7	Additional information .....	19
7.1	Software bugs.....	19
7.2	Line sensor readout electronics and PCB .....	19
7.3	Emitter drive schematic.....	20

**Please note:** the information contained in this document is **draft only** and subject to change without further notification. Pyreos reserves the right to alter the performance and any resulting specification. Pyreos may choose not to supply any engineering sample devices as a commercial product. No responsibility is accepted for any consequential loss incurred. Pyreos Ltd, SMC, West Mains Road, Edinburgh EH9 3JF, UK. Tel:+441316507009, [www.pyreos.com](http://www.pyreos.com); © Copyright Pyreos Ltd 2011

## 2 Introduction

This User Guide describes the software, hardware and installation process for Pyreos portable, robust, lightweight IR spectrometer demonstration units. The spectrometers are designed to be used as proof of principle demonstrations and as reference designs for customer's design work. The units are based on Pyreos unique pyroelectric line array sensors with the use of Linear Variable filters(LVF) as solid state dispersion gratings . Using this technical approach it is possible to take near, mid, or far IR spectral readings (dependent on the LVF used) in a few seconds, and in almost any working environment. The simplified principle of operation is shown below.

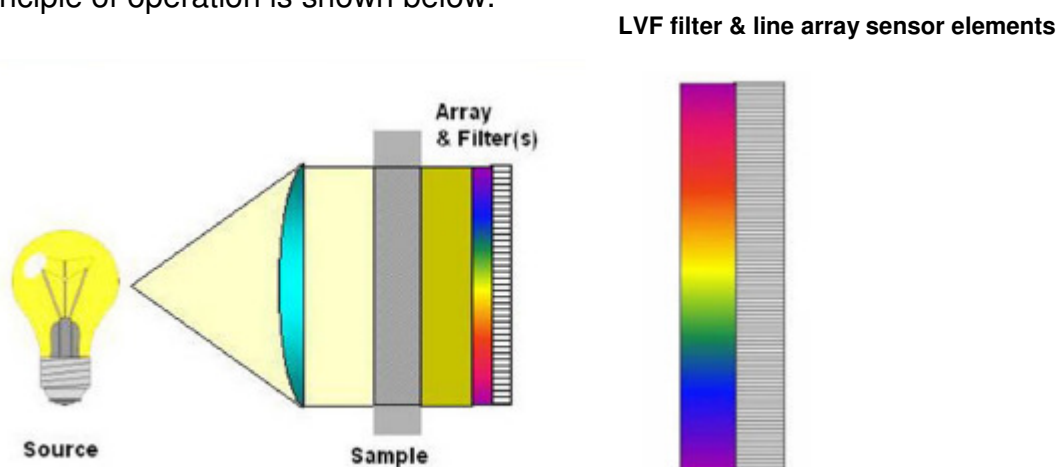

The demonstration units are available in line array sensor resolutions of 1x 128, 1x 255, 1x 510 and come fitted with a linear variable filter(LVF). The Pyreos line array demo-kit board( PYDK-LAS ) is used to provide the electronics. For more detailed information about the electronics and the capabilities of the Pyreos line array sensors please read the Pyreos User Guide, **PYDK-LAS**.

This format of miniature high performance solid state IR spectrometer is just one of several approaches enabled by Pyreos unique line array sensor products. The combination of line array sensor and LVF dispersion grating makes for highly robust, compact, lower cost spectral analysis, which can be tailored to an individual customer's wavelength range of

**Please note:** the information contained in this document is **draft only** and subject to change without further notification. Pyreos reserves the right to alter the performance and any resulting specification. Pyreos may choose not to supply any engineering sample devices as a commercial product. No responsibility is accepted for any consequential loss incurred. Pyreos Ltd, SMC, West Mains Road, Edinburgh EH9 3JF, UK. Tel:+441316507009, [www.pyreos.com](http://www.pyreos.com); © Copyright Pyreos Ltd 2011

interest. Please ask your Pyreos contact if you would like more information about other approaches to portable spectrometer solutions.

## 2.1 Linear Variable Filters (LVF)

There are several different methods for separating light in spectrometers. An LVF is one approach to providing spectrally separated light to the Pyreos line array sensor elements. An LVF is a band pass filter coating intentionally wedged in one direction. Since the centre wavelength is a function of the coating thickness, the peak centre wavelength will vary in a linear fashion in the direction of the wedge, as shown in the diagrams below.

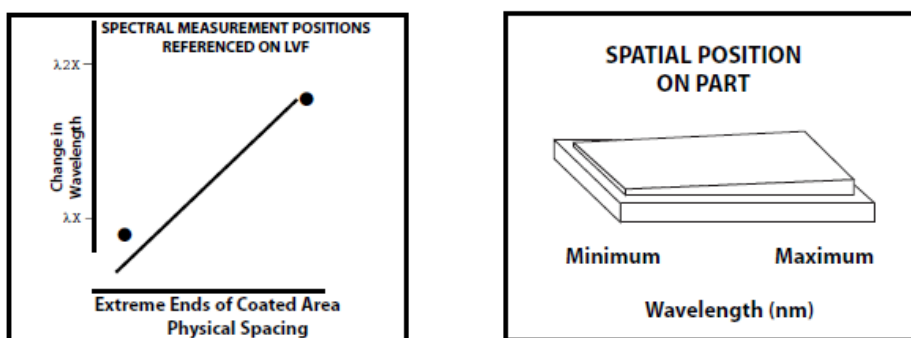

### Linear variable filter information

The centre transmission wavelength of light transmitted through the LVF varies linearly across the length of the filter. Therefore different wavelengths will be detected on different sensor elements of the underlying Pyreos line sensor array. The overall spectral resolution will be primarily dependent on the wavelength range of the LVF and the optical specification of the LVF, as well as the resolution of the Pyreos line array sensor used in the spectrometer. LVFs can be specified with Pyreos, and we can then source these and build them into spectrometer units to provide tailored customer specific wavelength ranges.

**Please note:** the information contained in this document is **draft only** and subject to change without further notification. Pyreos reserves the right to alter the performance and any resulting specification. Pyreos may choose not to supply any engineering sample devices as a commercial product. No responsibility is accepted for any consequential loss incurred. Pyreos Ltd, SMC, West Mains Road, Edinburgh EH9 3JF, UK. Tel:+441316507009, [www.pyreos.com](http://www.pyreos.com); © Copyright Pyreos Ltd 2011

Examples of LVF wavelength ranges that can be sourced include

1.0 $\mu\text{m}$ -2.0 $\mu\text{m}$ ;	1.3 $\mu\text{m}$ -2.6 $\mu\text{m}$ ;	2.5 $\mu\text{m}$ -5.0 $\mu\text{m}$
5.5 $\mu\text{m}$ -11 $\mu\text{m}$ ;	6.0 $\mu\text{m}$ -12.0 $\mu\text{m}$ ;	7.0 $\mu\text{m}$ -14.0 $\mu\text{m}$

If you are interested in other wavelengths, or further details please contact Pyreos to discuss your requirements.

## 2.2 ATR Spectrometer

Attenuated Total Reflection (ATR) spectroscopy is one method for analysing the infra-red spectrum absorbance of liquids. It provides a very simple way to sample liquids onto the sample surface of the ATR spectrometer and quickly take measurements. It also provides a simple way to integrate a spectrometer into an industrial process line enabling continuous process control measurements. The diagram below illustrates the principle of operation of an ATR spectrometer.

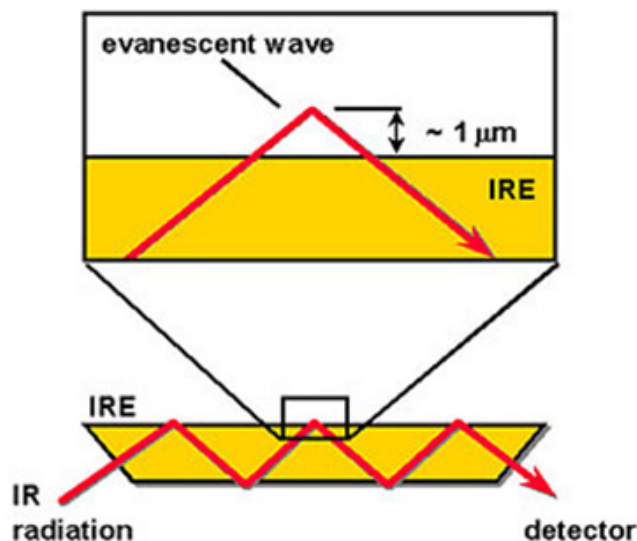

The optical principle of an ATR spectrometer

The transmittance plot below was measured using the ATR spectrometer demonstration unit and took 44 seconds to acquire. The alignment of the linear line array to linear

**Please note:** the information contained in this document is **draft only** and subject to change without further notification. Pyreos reserves the right to alter the performance and any resulting specification. Pyreos may choose not to supply any engineering sample devices as a commercial product. No responsibility is accepted for any consequential loss incurred. Pyreos Ltd, SMC, West Mains Road, Edinburgh EH9 3JF, UK. Tel:+441316507009, [www.pyreos.com](http://www.pyreos.com); © Copyright Pyreos Ltd 2011

variable filter is carefully calibrated during manufacture to ensure optimum spectral accuracy and that minimal red or blue wavelength shift occurs in the spectrum.

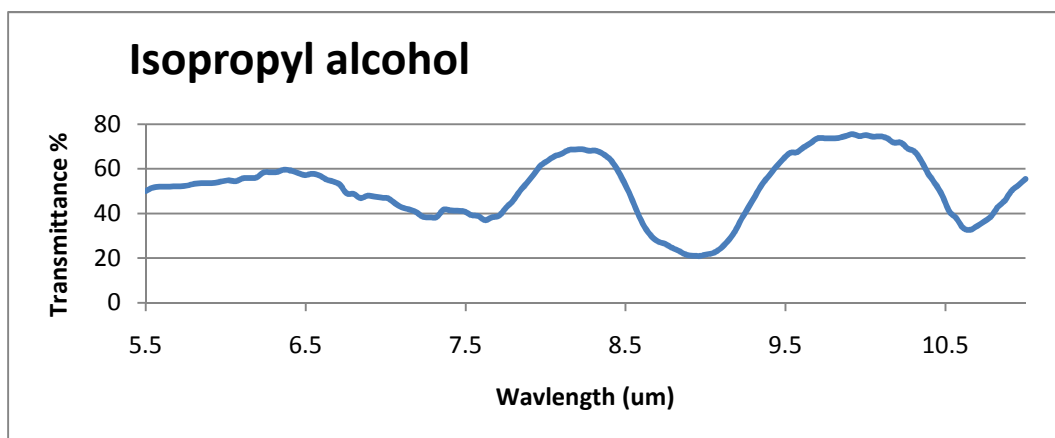

## 2.3 Transmission Spectrometer

The image below shows the transmission spectrometer.

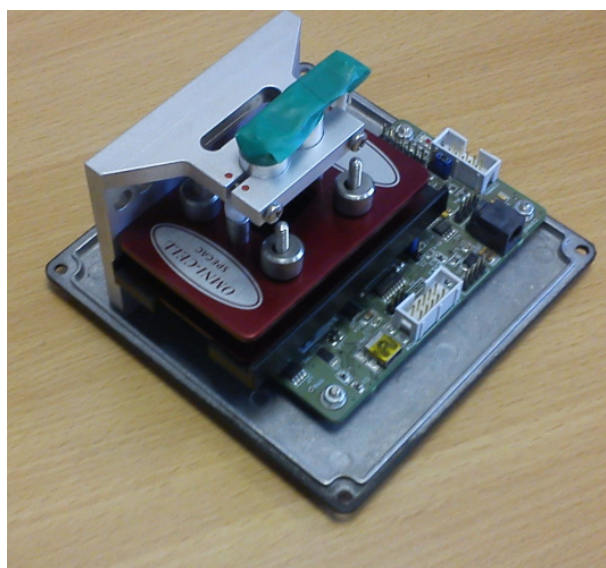

Transmission spectrometer

For this system, it is necessary to prepare sample for analysis in a transmission cell, which are available from a variety of suppliers. The transmission spectrometer unit was designed

**Please note:** the information contained in this document is **draft only** and subject to change without further notification. Pyreos reserves the right to alter the performance and any resulting specification. Pyreos may choose not to supply any engineering sample devices as a commercial product. No responsibility is accepted for any consequential loss incurred. Pyreos Ltd, SMC, West Mains Road, Edinburgh EH9 3JF, UK. Tel:+441316507009, [www.pyreos.com](http://www.pyreos.com); © Copyright Pyreos Ltd 2011

to take the Omni-cell transmission cell system from Specac Ltd:  
<http://www.specac.com/products/liquid-transmission-cell>.

### 2.3.1 Example measurement

Below are two measurements of Polystyrene spectrometer calibration cards from Thermo Scientific. These measurements were collected in under 30 seconds. The results are consistent with the standard films and provide evidence that the miniature spectrometer units can be used to provide out of the laboratory spectral analysis.

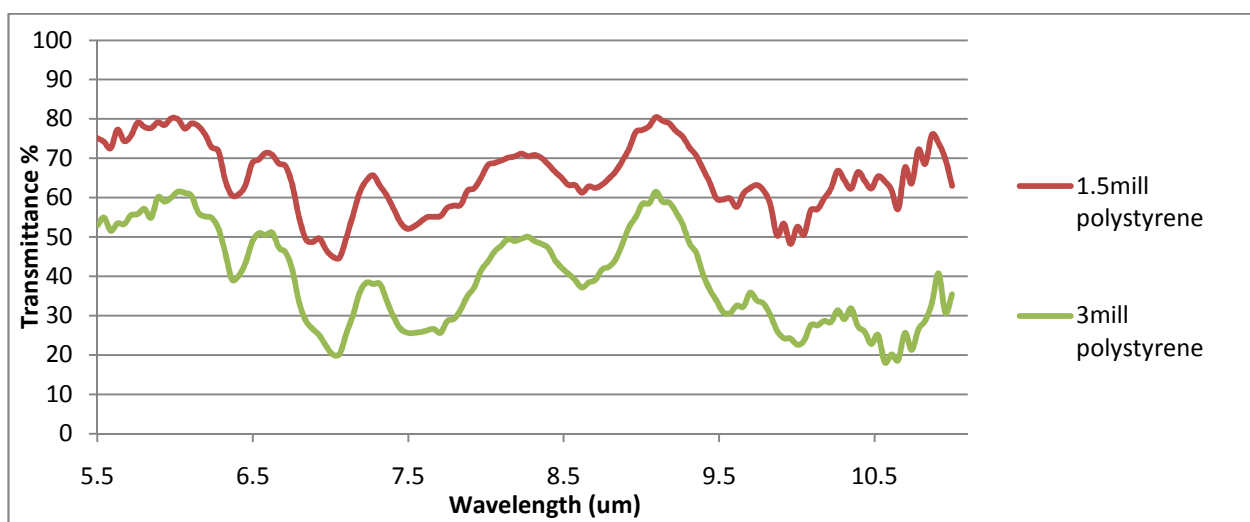

A variety of leading Universities and industry leaders have already developed ground-breaking inline and continuous process monitoring and quality control solutions using the Pyreos miniature ATR and transmission spectrometer units as the starting point for their designs. Publicly available results include the following publication which achieved accuracy similar to that of an FT-IR spectrometer in a real application setting.

[1] Wiesent, B.R.; Dorigo, D.G.; Schardt, M.; Koch, A.W. **Gear oil condition monitoring for offshore wind turbines using band limited resolution spectra**. In: Proc. of OilDoc Conference and Exhibiton 2011, 01.-03.02.2011, Bavaria, Germany

**Please note:** the information contained in this document is **draft only** and subject to change without further notification. Pyreos reserves the right to alter the performance and any resulting specification. Pyreos may choose not to supply any engineering sample devices as a commercial product. No responsibility is accepted for any consequential loss incurred. Pyreos Ltd, SMC, West Mains Road, Edinburgh EH9 3JF, UK. Tel:+441316507009, [www.pyreos.com](http://www.pyreos.com); © Copyright Pyreos Ltd 2011



## 3 Kit Contents

1. 9V DC Power supply
2. Mini USB cable
3. PYDK-SPEC Software CD
4. Spectrometer module (one of the following)

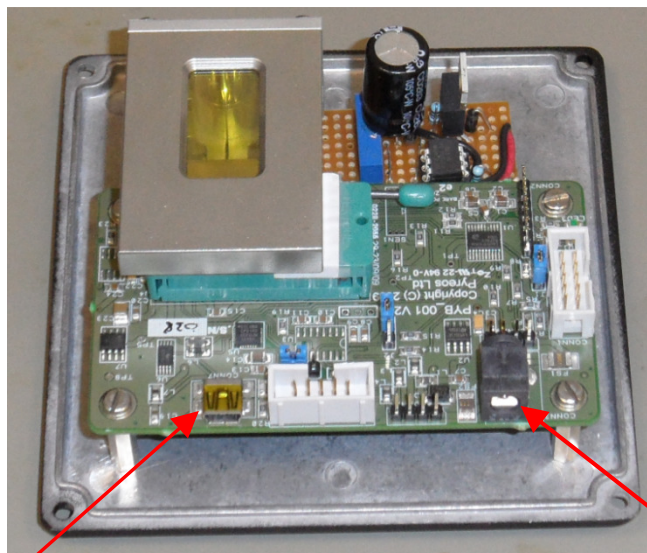

ATR Spectrometer

Micro USB  
connector

9V DC power  
connector

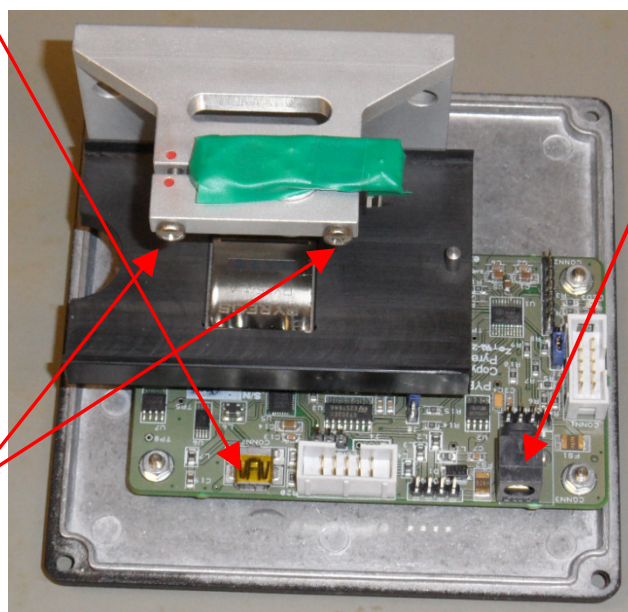

Transmission Spectrometer

Emitter position  
adjustment  
screws

**Please note:** the information contained in this document is **draft only** and subject to change without further notification. Pyreos reserves the right to alter the performance and any resulting specification. Pyreos may choose not to supply any engineering sample devices as a commercial product. No responsibility is accepted for any consequential loss incurred. Pyreos Ltd, SMC, West Mains Road, Edinburgh EH9 3JF, UK. Tel:+441316507009, [www.pyreos.com](http://www.pyreos.com); © Copyright Pyreos Ltd 2011





## 4 Quick Start

1. Connect the USB cable from the PC to the spectrometer module
  - a. Your computer should tell you that it has found new hardware and is searching for a device driver.
2. If it asks you for a driver disk, the files can be found on your CD in the directory named “CP2102 Driver”
3. Install your Pyreos spectrometer software
  - a. Run “setup” on the enclosed CD and follow the on-screen instructions
4. Connect the power supply to the spectrometer module
  - a. The yellow LED on the spectrometer should light up to show that the kit has power
5. Start the Pyreos spectrometer software (detailed in section 4), from;
  - a. All programs->Pyreos-> LVF Spectrometer
    - i. The software will start looking for the spectrometer module
    - ii. When it is found the display will change showing that the module is connected and detailing which communications port is in use.
    - iii. If a spectrometer module is not found within 30 seconds try removing the USB cable, waiting for 15 seconds, and then reconnecting it.

*You are now ready to start taking readings as you would with other spectrometers.*

6. Select the filename you wish to store your readings (File→ Save As)
  - a. Choose the filename and location to save the data in the “save as” dialogue box
7. Take a background reading (Click “Capture background of”)
  - a. While the software is taking the reading a moving Pyreos logo will be displayed on your screen
  - b. When the background capture is finished an additional window will open showing the background reading (it may be hidden behind the main application window)

**Please note:** the information contained in this document is **draft only** and subject to change without further notification. Pyreos reserves the right to alter the performance and any resulting specification. Pyreos may choose not to supply any engineering sample devices as a commercial product. No responsibility is accepted for any consequential loss incurred. Pyreos Ltd, SMC, West Mains Road, Edinburgh EH9 3JF, UK. Tel:+441316507009, [www.pyreos.com](http://www.pyreos.com); © Copyright Pyreos Ltd 2011



8. Place your prepared specimen on the spectrometer (as detailed in section 5)
9. Enter a name for the reading you are taking in the “Spectrum title” box (this will be stored in the data file, so you can examine the data later).
10. Take your reading (Click “Capture spectra of”)
  - a. While the software is taking the reading a moving Pyreos logo will be displayed on your screen
  - b. When the reading is captured a new graph window will open showing the transmission graph.

## 5 Using your spectrometer

This section outlines key handling and operating procedures for your spectrometer.

### 5.1 Placing specimens on your ATR spectrometer

Pipette your specimen onto this window, ensuring that sufficient liquid is used to cover the whole window area.

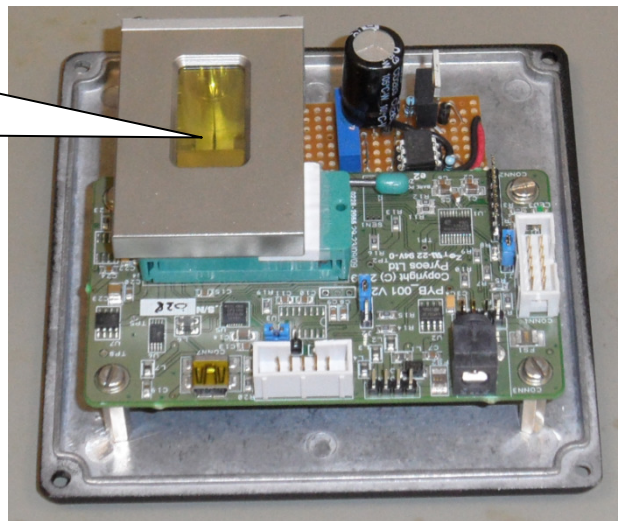

### 5.2 Cleaning and care of the ATR crystal

The ATR crystal window is made from zinc selenide (ZnSe) coated to provide a toughened scratch resistant surface and has the appearance of yellow coloured glass. Zinc selenide

**Please note:** the information contained in this document is **draft only** and subject to change without further notification. Pyreos reserves the right to alter the performance and any resulting specification. Pyreos may choose not to supply any engineering sample devices as a commercial product. No responsibility is accepted for any consequential loss incurred. Pyreos Ltd, SMC, West Mains Road, Edinburgh EH9 3JF, UK. Tel:+441316507009, [www.pyreos.com](http://www.pyreos.com); © Copyright Pyreos Ltd 2011

is chosen for its high IR optical transmission and its mechanical robustness. It is important to keep the ATR scratch free, as scratches create optical aberrations on the surface of the ATR which prevent the spectrometer from working to maximum potential. Please ensure the ATR window is clean before starting your measurements. If using tissues for cleaning processes use lint free lens tissues or other non scratch materials.

As with all glass like materials please take safety precautions at all times, and in the unfortunate event that the ATR window is damaged, cracked or broken please refer to safety guidelines for the safe handling of zinc selenide material such as those available at [http://msds.chem.ox.ac.uk/Zl/zinc\\_selenide.html](http://msds.chem.ox.ac.uk/Zl/zinc_selenide.html) . It is important not to inhale or ingest any dust or fragments of ZnSe.

### 5.3 Placing the transmission cell into the transmission mode spectrometer

The transmission sample cell can be placed in the spectrometer unit by sliding it into the black draw in the transmission kit, as shown in the images below. The cell can be used to record a background reading and then filled with sample material to record a spectrum.

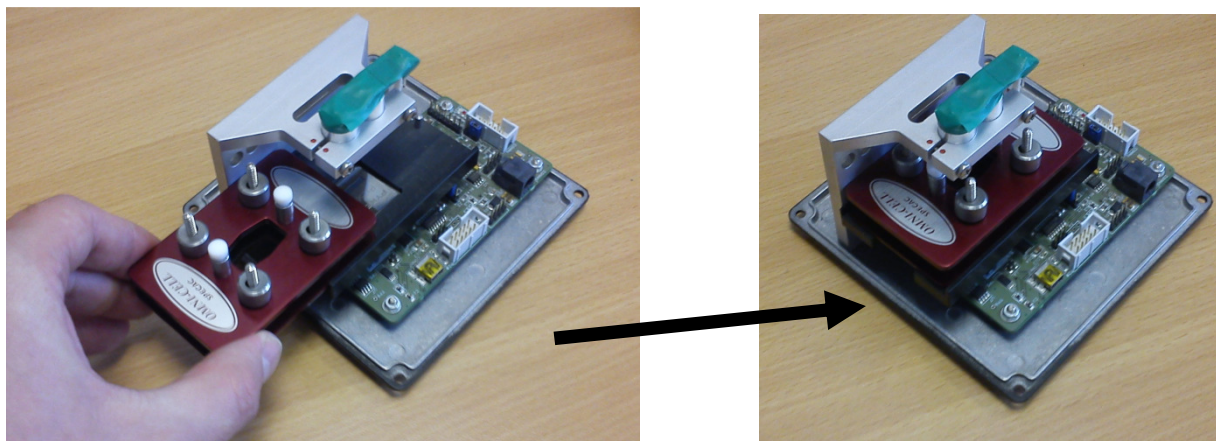

**Please note:** the information contained in this document is **draft only** and subject to change without further notification. Pyreos reserves the right to alter the performance and any resulting specification. Pyreos may choose not to supply any engineering sample devices as a commercial product. No responsibility is accepted for any consequential loss incurred. Pyreos Ltd, SMC, West Mains Road, Edinburgh EH9 3JF, UK. Tel:+441316507009, [www.pyreos.com](http://www.pyreos.com); © Copyright Pyreos Ltd 2011



## 6 Software user guide

To start the Pyreos Spectrometer, select the link from your start menu. The default install location is: All Programs→Pyreos→LVF Spectrometer.

This will open up the Pyreos LVF spectrometer main window, shown below.

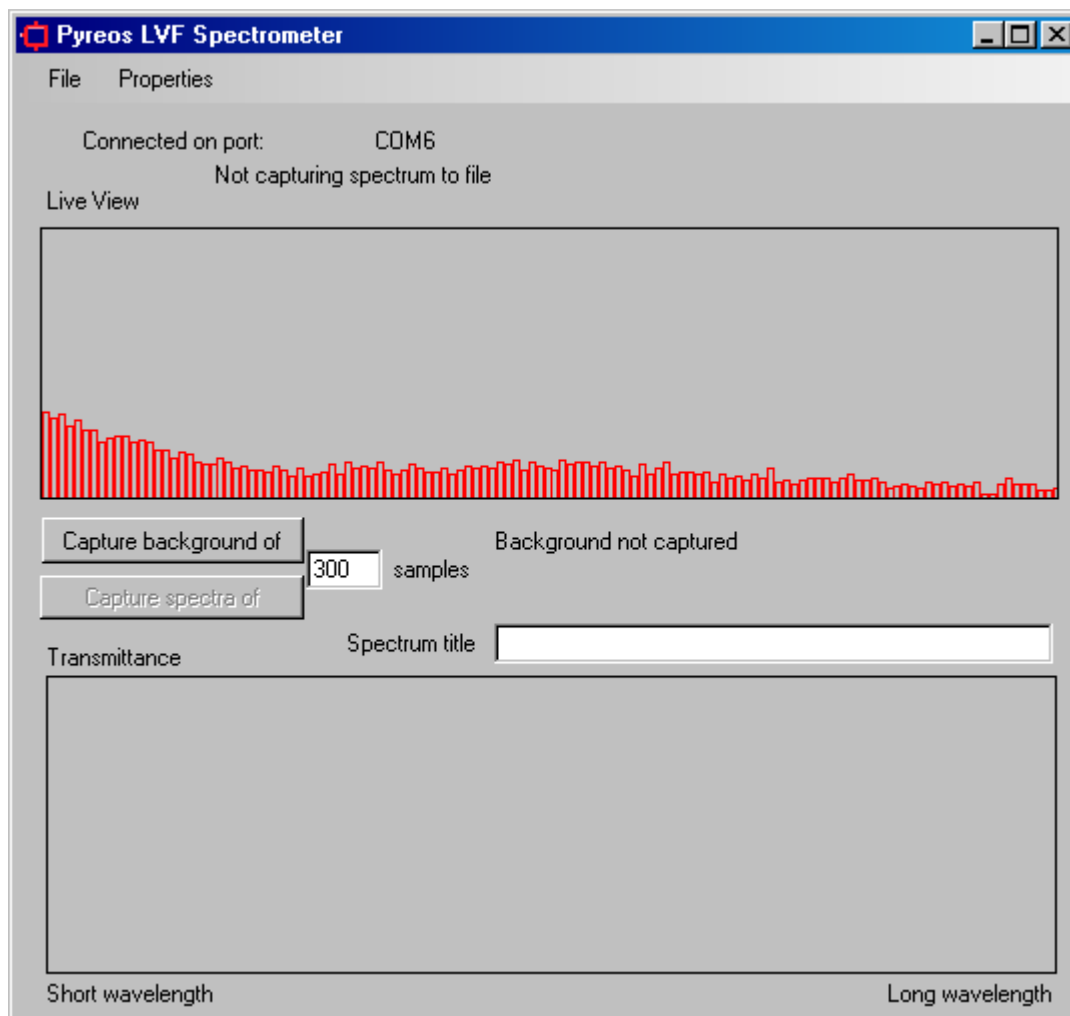

The software application will continually search through your computer's COM ports testing for the Pyreos spectrometer. When it finds a spectrometer the software will connect to it and the display will update as shown overleaf.

**Please note:** the information contained in this document is **draft only** and subject to change without further notification. Pyreos reserves the right to alter the performance and any resulting specification. Pyreos may choose not to supply any engineering sample devices as a commercial product. No responsibility is accepted for any consequential loss incurred. Pyreos Ltd, SMC, West Mains Road, Edinburgh EH9 3JF, UK. Tel:+441316507009, [www.pyreos.com](http://www.pyreos.com); © Copyright Pyreos Ltd 2011

# PYREOS

The image below shows the software main display. Each element of the display and software is explained in this section.

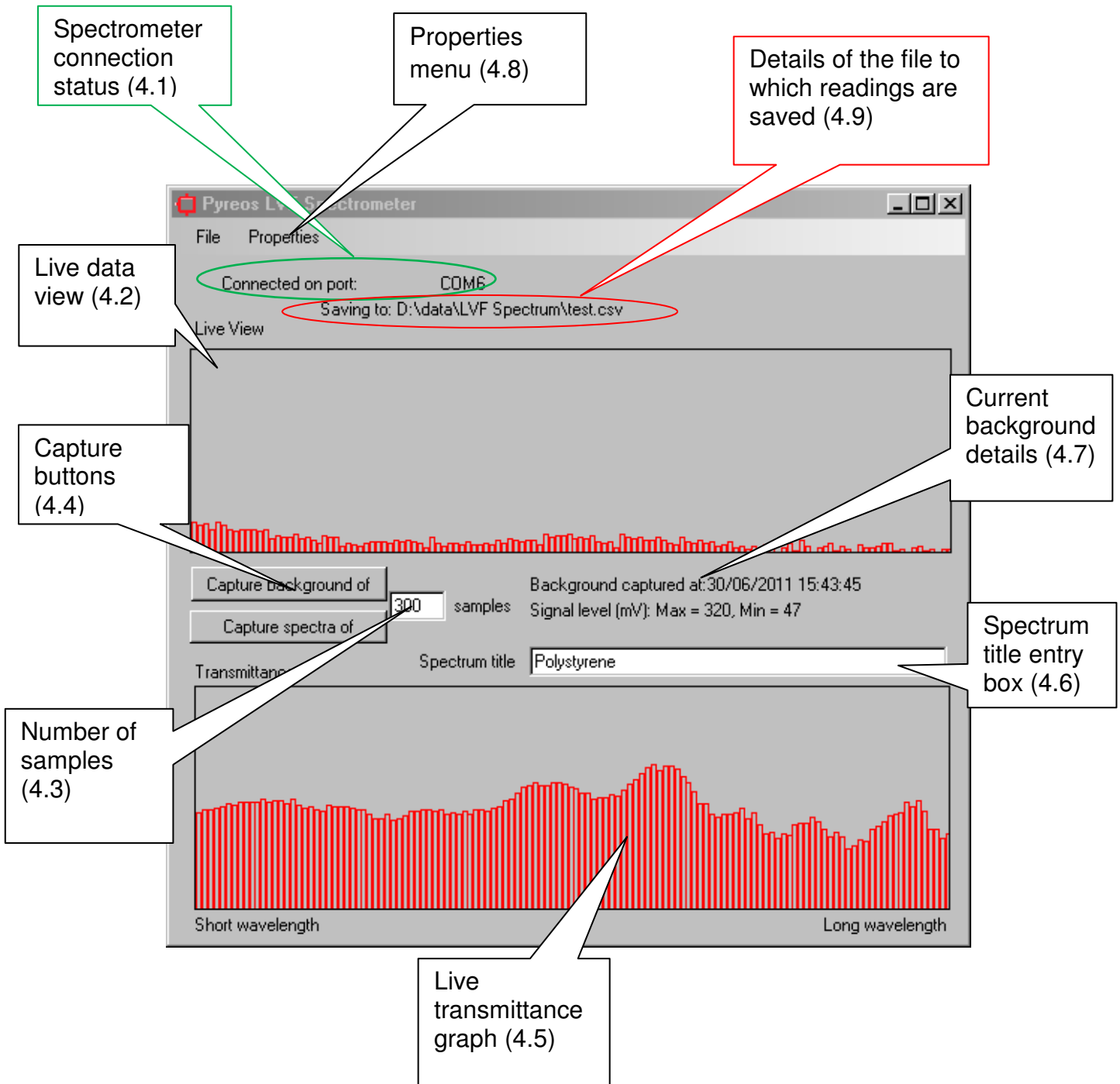

**Please note:** the information contained in this document is **draft only** and subject to change without further notification. Pyreos reserves the right to alter the performance and any resulting specification. Pyreos may choose not to supply any engineering sample devices as a commercial product. No responsibility is accepted for any consequential loss incurred. Pyreos Ltd, SMC, West Mains Road, Edinburgh EH9 3JF, UK. Tel:+441316507009, [www.pyreos.com](http://www.pyreos.com); © Copyright Pyreos Ltd 2011

## 6.1 Spectrometer connection status

This text shows the software's connection status. As stated previously, when you first start the spectrometer software it will begin scanning all available COM ports on your computer looking for a Pyreos spectrometer. This process will be indicated by the text "Searching for spectrometer" displayed on the screen in the connection status text.

When PYDK-LAS hardware (used in the spectrometer) is found, the software will automatically connect to it and start collecting data. This will be indicated by the text changing to "Connected on port: COMx" where x denotes the USB to serial communications port the spectrometer is connected to.

## 6.2 Live data view

This display rectangle shows the live signals measured by the Pyreos line array through the LVF. The higher the signals in this box the better the signal to noise ratio you achieve. The S/N ratio will vary depending on the amount of light reaching the sensor of a particular wavelength, which will be dependent on the IR source characteristics and the LVF range in use.

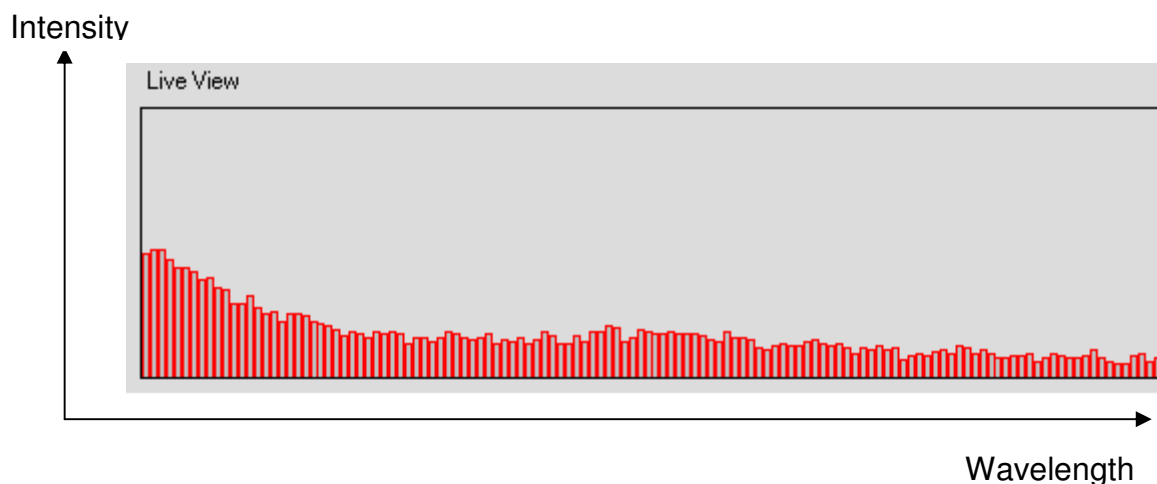

## 6.3 Number of samples

**Please note:** the information contained in this document is **draft only** and subject to change without further notification. Pyreos reserves the right to alter the performance and any resulting specification. Pyreos may choose not to supply any engineering sample devices as a commercial product. No responsibility is accepted for any consequential loss incurred. Pyreos Ltd, SMC, West Mains Road, Edinburgh EH9 3JF, UK. Tel:+441316507009, [www.pyreos.com](http://www.pyreos.com); © Copyright Pyreos Ltd 2011





As with most spectrometers every reading contains a mix of signal and noise. As noise typically has a normal distribution, taking the average of a large number of readings improves the accuracy of the measurement. However, it also takes longer to take the measurement as more samples must be collected, so selection of the appropriate number of samples is a trade-off between quality of measurement and time taken to collect the readings. Generally, increasing the number of samples by a factor of four will double the detection accuracy.

*Note: If you change the number of samples or any other settings, it is necessary to re-capture the background.*

#### 6.4 Capture buttons

There are two different capture buttons on the main display shown below: “Capture background of” and “Capture spectra of”. The latter is only available after a background reading has been measured.

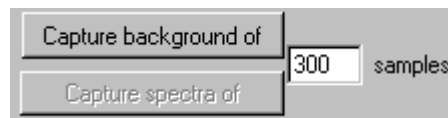

Before placing your sample for analysis on/in the spectrometer it is necessary to take a reading of the background signal, which is done by clicking “Capture background of”. The background signal is “subtracted “away from the sample signal so that any change or difference can be detected. The background signal can therefore be chosen by the user. Typically a background scan may be of the empty sample transmission cell, or of the initial liquid or gas material for continuous monitoring applications. The Pyreos logo will be displayed on your screen while it is collecting the specified number of background samples. The number shown will count down to zero during this time. When the background has been collected to the specified number of samples the Pyreos logo will disappear and the spectrometer will be ready for use.

**Please note:** the information contained in this document is **draft only** and subject to change without further notification. Pyreos reserves the right to alter the performance and any resulting specification. Pyreos may choose not to supply any engineering sample devices as a commercial product. No responsibility is accepted for any consequential loss incurred. Pyreos Ltd, SMC, West Mains Road, Edinburgh EH9 3JF, UK. Tel:+441316507009, [www.pyreos.com](http://www.pyreos.com); © Copyright Pyreos Ltd 2011

# PYREOS

The “Capture spectra of” button will now be available and an additional window showing the background reading (shown overleaf) will have opened, although this is usually hidden behind the current window.

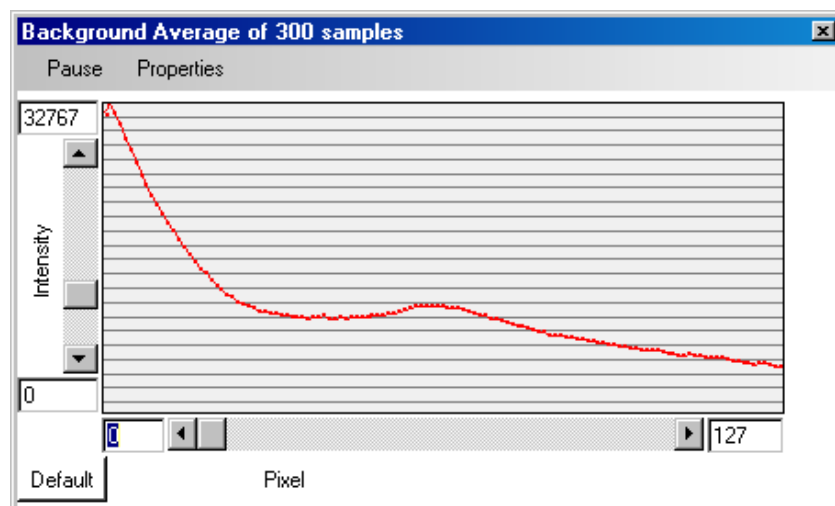

A more detailed description of how to use the controls in the above window can be found on page 16 of the PYDK-LAS User Guide which is included on your CD .

Now that the “Capture spectra of” button is enabled it is time to place your sample for analysis on/in the spectrometer. Next enter the title you wish to give this in the “Spectrum title” box and click “Capture spectra of”. The Pyreos Logo will display itself on the screen while the measurement is being collected. When the data collection has finished a new window similar to the graph shown above will open showing the spectrum taken. The data will also be stored in a file if you have opted to save data to file (as detailed in 6.9).

**Please note:** the information contained in this document is **draft only** and subject to change without further notification. Pyreos reserves the right to alter the performance and any resulting specification. Pyreos may choose not to supply any engineering sample devices as a commercial product. No responsibility is accepted for any consequential loss incurred. Pyreos Ltd, SMC, West Mains Road, Edinburgh EH9 3JF, UK. Tel:+441316507009, [www.pyreos.com](http://www.pyreos.com); © Copyright Pyreos Ltd 2011

# PYREOS

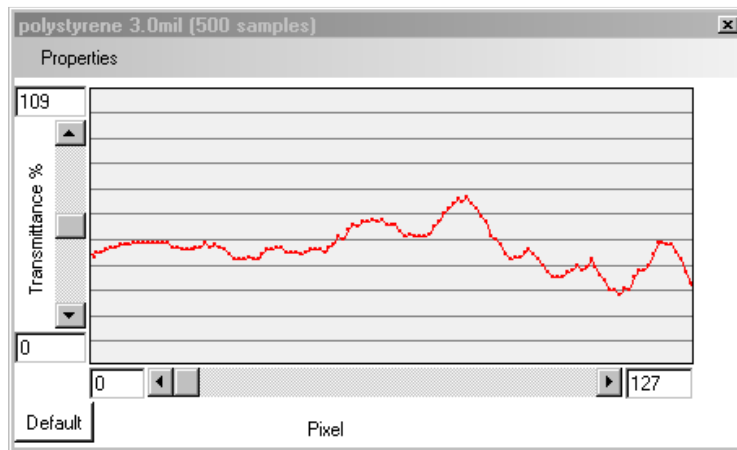

## 6.5 Live transmittance graph

At the bottom of the main screen there is a histogram display showing the transmittance measurements live as they are captured. How quickly they change depends on how many samples the software is set to average over. This provides an easy to view, real-time image of the transmittance readings. Long wavelengths are to the right of the screen and shorter wavelengths are to the left of the screen. The exact wavelength range to be measured will depend on the specific LVF selected for your spectrometer.

## 6.6 Spectrum title

By clicking the “Capture spectra of” button, all readings taken will be named with the text entered in this box. The name will appear in both the CSV file (if it is being used) and in the title of the on screen transmission graph.

## 6.7 Current background details

This text displays details of the background currently being used to calculate spectral transmission. The time and date when it was captured is displayed as is the number of samples averaged and the maximum and minimum signal levels.

## 6.8 Properties dialogue box

The properties dialogue box shown below is opened by clicking “Properties” from the menu.

**Please note:** the information contained in this document is **draft only** and subject to change without further notification. Pyreos reserves the right to alter the performance and any resulting specification. Pyreos may choose not to supply any engineering sample devices as a commercial product. No responsibility is accepted for any consequential loss incurred. Pyreos Ltd, SMC, West Mains Road, Edinburgh EH9 3JF, UK. Tel:+441316507009, [www.pyreos.com](http://www.pyreos.com); © Copyright Pyreos Ltd 2011

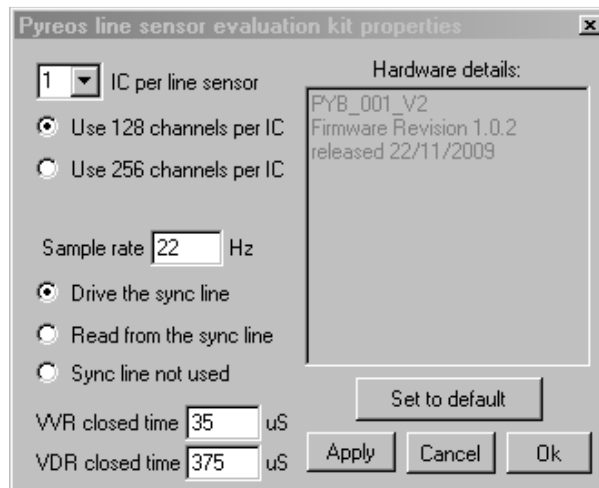

This box has several settings which can aid the development and optimization of new spectrometer products. Details of its operation can be found in the PYDK-LAS User Guide included on your evaluation kit CD and also available for download from Pyreos web-site <http://www.pyreos.com/>

Settings which you may wish to change when using your prototype spectrometer are:

- Sample rate
  - For reasons described on page 11 of PYDK-LAS user guide the actual number of samples will be half this value (so if sample rate = 20Hz and number of samples =300 the spectrometer will take 30s to capture its sample)
  - Faster = better spectral resolution but reduced s/n ratio (up to ~50Hz)
  - Slower (no point in reducing below 20 Hz) = better s/n ratio but worse spectral resolution
- Number of channels per IC allows selection of the appropriate number of pixels for the line array in use, 128 or 255.
  - If you wish to use the 510 pixel line array you must set the number of IC to 2 and use 256 channels

**Please note:** the information contained in this document is **draft only** and subject to change without further notification. Pyreos reserves the right to alter the performance and any resulting specification. Pyreos may choose not to supply any engineering sample devices as a commercial product. No responsibility is accepted for any consequential loss incurred. Pyreos Ltd, SMC, West Mains Road, Edinburgh EH9 3JF, UK. Tel:+441316507009, [www.pyreos.com](http://www.pyreos.com); © Copyright Pyreos Ltd 2011



## 6.9 Details of the file to which readings are saved

The Pyreos spectrometer software provides built in functionality to store data to comma separated value files, which can easily be imported into excel or other data analysis packages. This box either states “Not capturing spectrum to file” or shows the path and filename of the file which you are presently saving to. You can change the file you are saving to by going to File→Save As.

### Saved data format

The data saved in csv (comma separated value) files contains one row for every spectrum captured. The first four coulombs provide details of the measurement taken as described below:

1. Time & date when the background was measured
2. Time & date when the measurement was taken
3. The number of samples over which the measurement was averaged
4. The reading name
  - a. This is the text which was entered in the Spectrum title box described above at the time the “Capture reading” button was clicked

Example data shown below:

Background captured at:09/05/2011 09:17:35	Sample captured at:09/05/2011 09:18:48	number of samples averaged: 500	Sample name: <i>Background 10Hz</i>	99.75566	...	100.1302
Background captured at:09/05/2011	Sample captured at:09/05/2011	number of samples averaged: 500	Sample name: <i>Isopropyl</i>	50.05157	....	51.53464

**Please note:** the information contained in this document is **draft only** and subject to change without further notification. Pyreos reserves the right to alter the performance and any resulting specification. Pyreos may choose not to supply any engineering sample devices as a commercial product. No responsibility is accepted for any consequential loss incurred. Pyreos Ltd, SMC, West Mains Road, Edinburgh EH9 3JF, UK. Tel:+441316507009, [www.pyreos.com](http://www.pyreos.com); © Copyright Pyreos Ltd 2011



09:17:35	09:21:22		alcohol 10Hz			
----------	----------	--	--------------	--	--	--

Every other entry in the row is a transmission measurement specified in % for the corresponding pixel from the array. There will be either 128, 256 or 512 measurements depending on the software setting you select, as detailed in section 6.8 of this guide.

*Note: the wavelength for each measurement is not calibrated and you may find slight non linear increments in wavelength across the array of readings.*

## 7 Additional information

### 7.1 Software bugs

There is a known problem with the way Microsoft.net framework and 3<sup>rd</sup> party device drivers handle unexpected removal of USB serial ports which are in use. This can lead to your computer crashing with a Microsoft stop error. The issues have been reported to Microsoft and Silicon labs Inc who supply the USB to serial port converts and drivers. Check your PC is up to date by using Microsoft update. **Pyreos recommends exiting from the spectrometer software prior to removing the USB cable or power supply.**

### 7.2 Line sensor readout electronics and PCB

Information about the electronics, PCB and data format for integration into other systems can be found in the Pyreos line sensor evaluation kit user guide; PKDK-LAS included on your CD and available to download from <http://www.pyreos.com/products/line-sensors.html>.

**Please note:** the information contained in this document is **draft only** and subject to change without further notification. Pyreos reserves the right to alter the performance and any resulting specification. Pyreos may choose not to supply any engineering sample devices as a commercial product. No responsibility is accepted for any consequential loss incurred. Pyreos Ltd, SMC, West Mains Road, Edinburgh EH9 3JF, UK. Tel:+441316507009, [www.pyreos.com](http://www.pyreos.com); © Copyright Pyreos Ltd 2011





### 7.3 Emitter drive schematic

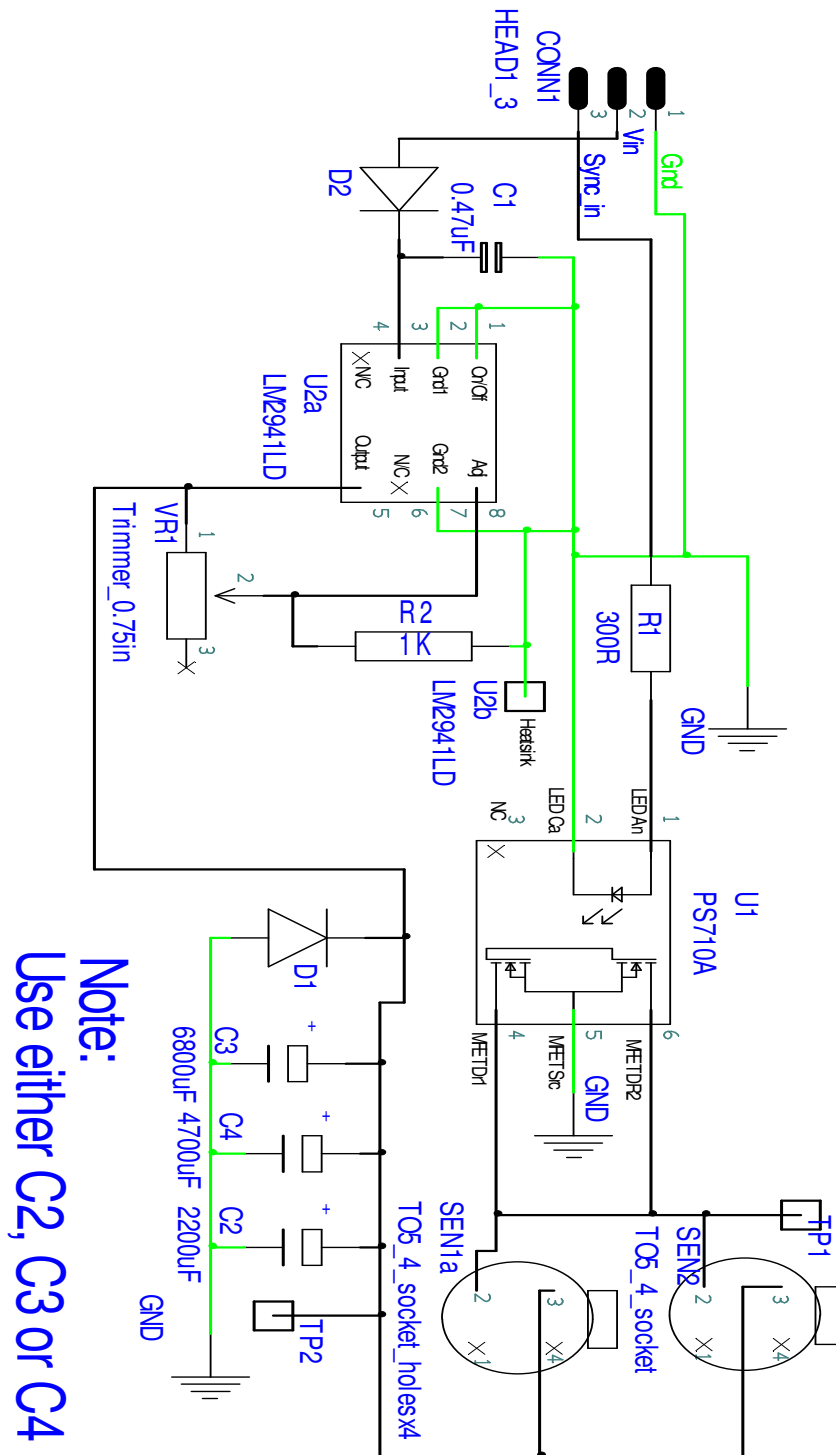

**Please note:** the information contained in this document is **draft only** and subject to change without further notification. Pyreos reserves the right to alter the performance and any resulting specification. Pyreos may choose not to supply any engineering sample devices as a commercial product. No responsibility is accepted for any consequential loss incurred. Pyreos Ltd, SMC, West Mains Road, Edinburgh EH9 3JF, UK. Tel:+441316507009, [www.pyreos.com](http://www.pyreos.com); © Copyright Pyreos Ltd 2011