

0/4...20 mA Output • Hazardous Area Certification
Ranges: 0-90° to 0-50 Turns
Industrial Grade

RT9420



Specification Summary:

GENERAL
 Full Stroke Range Options 0-0.125 to 0-50 turns
 Output Signal Options 4...20 mA (2-wire) and 0...20 mA (3-wire)
 Accuracy ± 0.30% to ±0.15% full stroke *see ordering information*
 Repeatability ± 0.05% full stroke
 Resolution essentially infinite
 Enclosure Material Options powder-painted aluminum or stainless steel
 Sensor plastic-hybrid precision potentiometer
 Potentiometer Cycle Life *see ordering information*
 Shaft Loading up to 35 lbs. radial and 5 lbs. axial
 Weight, Aluminum (Stainless Steel) Enclosure 5 lbs. (10 lbs.) max.

ELECTRICAL *see ordering information*
 Input Voltage *see ordering information*
 Input Current 20 mA max.
 Maximum Loop Resistance (Load) (loop supply voltage - 8)/0.020
 Circuit Protection38 mA max.
 Impedance 100M ohms@100 VDC, min.
 Output Signal Adjustment
 Zero Adjustment from factory set zero to 50% of full stroke range
 Span Adjustment to 50% of factory set span
 Thermal Effects
 Zero 0.01% f.s./°F, max.
 Span 0.01% f.s./°F, max.

ENVIRONMENTAL
 Enclosure NEMA 4/4X/6, IP 67/68
 Hazardous Area Certification *see ordering information*
 Operating Temperature -40° to 200°F (-40° to 90°C)
 Vibration up to 10 G's to 2000 Hz maximum

EMC COMPLIANCE PER DIRECTIVE 89/336/EEC
 Emission/Immunity EN50081-2/EN50082-2

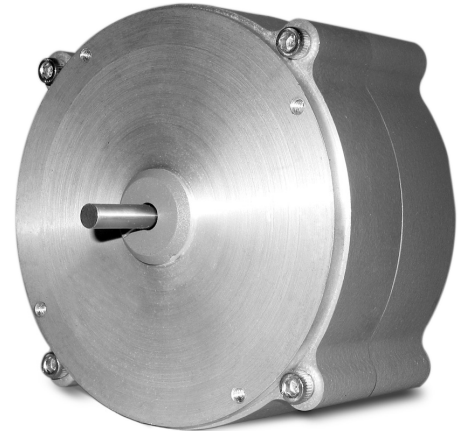

The RT9420 provides rotational position feedback via 4...20 mA current loop signal. This device combines the superb linearity and resolution of a plastic-hybrid potentiometer and the durability of Celesco's 4...20mA circuit to provide an accurate and reliable electrical signal. Additionally the zero and span settings are adjustable through access holes in the housing.

This innovative sensor from Celesco, designed to meet NEMA-4 and IP67 standards, is available in full stroke ranges of 1/4 to 50 turns.

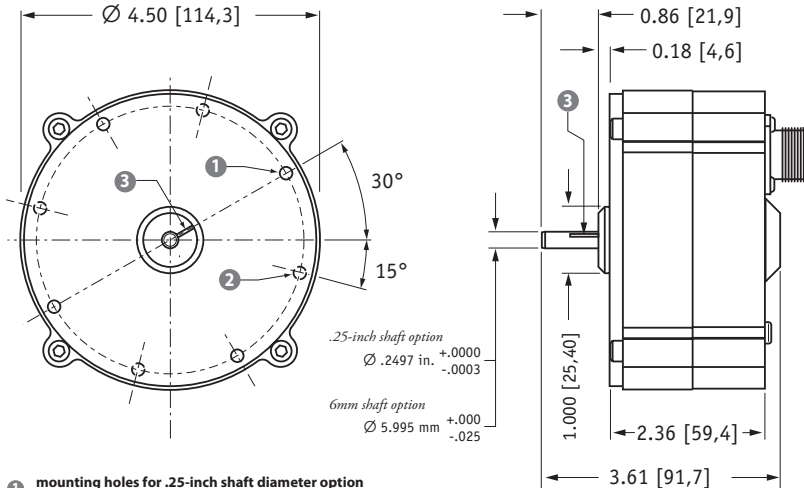

- 1 mounting holes for .25-inch shaft diameter option #8-32 x 0.180 @ 90° apart on a 4.15 in. dia. BC (4 places)
- 2 mounting holes for 6-mm shaft diameter option M4 x 4.5 mm @ 90° apart on a 105.4 mm dia. BC (4 places)
- 3 reference mark full counter-clockwise position - align mark on shaft to mark on face for start of measurement range

ALL DIMENSIONS ARE IN INCHES [MM]

Output Signal

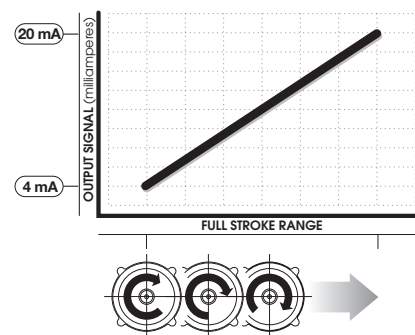

Ordering Information:

Model Number:

RT9420- _____ **-** _____ **-** _____ **1** **-** **1** _____ **0**

order code: **R** **A** **B** **C** **D** **E** **F** **G**

Sample Model Number:

RT9420 - 0005 - 111 - 1110

- R** range: 5 turns (clockwise shaft rotations)
- A** enclosure: aluminum
- B** shaft diameter: .25 inches
- F** output signal: 4...20 mA signal increasing clockwise
- F** electrical connection: 6-pin plastic connector

Full Stroke Range:





R order code:	R125	OR25	OR50	0001	0002	0003	0005	0010	0020	0030	0050
clockwise shaft rotations, min:	0.125	0.25	0.50	1	2	3	5	10	20	30	50
accuracy (% of f.s.):	0.3%	0.3%	0.3%	0.3%	0.3%	0.3%	0.2%	0.15%	0.15%	0.15%	0.15%
potentiometer cycle life*:	2.5 x 10 ⁶	2.5 x 10 ⁶	2.5 x 10 ⁶	2.5 x 10 ⁶	2.5 x 10 ⁶	2.5 x 10 ⁶	5 x 10 ⁵	2.5 x 10 ⁵	2.5 x 10 ⁵	2.5 x 10 ⁵	2.5 x 10 ⁵

*-number of times the sensor shaft can be cycled back and forth from beginning to end and back to the beginning before any measurable signal degradation may occur.













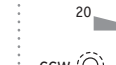



Enclosure Material:

A order code:	1	2
	powder-painted aluminum	303 stainless steel

Shaft Diameter:

B order code:	1	2	3	4
	0.25-in. diameter	6 mm diameter	0.25-in. dia. w/flats	6 mm dia. w/flats
				
	.2497 in. (+.0000 -0.0003)	5.995 mm (+.000 -0.025)	0.33 in. 0.025 in.	8.4 mm 0.64 mm

Output Signals:

F order code:	1	2	3	4	5*	6*
output signal options:	4...20 mA	20...4 mA	0...20 mA	20...0 mA	4...20 mA	20...4 mA
						
	ccw  cw 	ccw  cw 	ccw  cw 	ccw  cw 	ccw  cw 	ccw  cw 
sensitivity:	16 mA/full stroke ±0.25%		20 mA/full stroke ±0.25%		16 mA/full stroke ±0.25%	
wiring configuration:	2 - wire		3 - wire		2 - wire	
input voltage:	8 - 34 vdc		14 - 29 vdc		14 - 32 vdc	
hazardous area certification:	not certified		not certified		CSA • Cenelec	

Example:

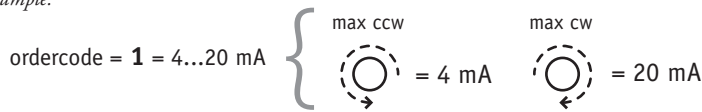

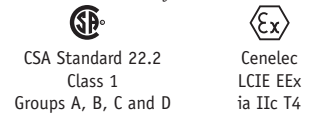

Hazardous Area Certifications:



***IMPORTANT:** intrinsically safe when powered from a CSA certified zener barrier rated 28 VDC max, 110 mA max per installation drawing#677984

Ordering Information:

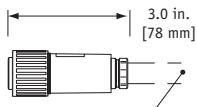
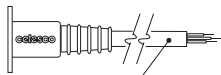
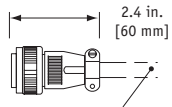
Electrical Connection:

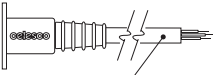
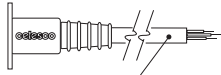
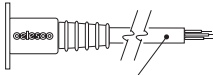
<p>1</p> <p>6-pin plastic connector w/mating plug IP 67, NEMA 4X**, 6</p>  <p>3.0 in. [78 mm]</p> <p>1/2 - 5/16" [14 - 8 mm] cable dia. 16 AWG max conductor size connector: MS3102E-14S-6P mating plug: MS3106E-14S-6S</p>	<p>2</p> <p>10-ft. [3 M] waterproof cable IP 67, NEMA 4X**, 6</p>  <p>10 ft. x 0.4-in. dia. [3 M x 10 mm dia.] 18 AWG, type SJTW</p>	<p>3</p> <p>6-pin metal connector w/mating plug IP 65, NEMA 4</p>  <p>2.4 in. [60 mm]</p> <p>3/8-in. [9 mm] max cable dia. 16 AWG max conductor size connector: MS3102E-14S-6P mating plug: MS3106E-14S-6S</p>	<p>4</p> <p>25-ft. [7.5 M] instrumentation cable IP 67, NEMA 6</p>  <p>25 ft. x 0.2-in. dia. [7.5 M x 5 mm dia.] 24 AWG, shielded</p>
<p>5</p> <p>100-ft. [30 M] waterproof cable IP 67, NEMA 4X**, 6</p>  <p>100 ft. x 0.4-in. dia. [30 M x 10 mm dia.] 18 AWG, type SJTW</p>	<p>6</p> <p>10-ft. [3 M] pressure tested* waterproof cable IP 68, NEMA 4X**, 6P</p>  <p>10 ft. x 0.4-in. dia. [3 M x 10 mm dia.] 18 AWG, type SJTW</p>	<p>7</p> <p>100-ft. [30 M] pressure tested* waterproof cable IP 68, NEMA 4X**, 6P</p>  <p>100 ft. x 0.4-in. dia. [30 M x 10 mm dia.] 18 AWG, type SJTW</p>	

6-pin Mating Plug			Waterproof Cable			Instrumentation Cable		
pin	2-wire	3-wire	color code	2-wire	3-wire	color code	2-wire	3-wire
A	8...34 vdc***	14...29 vdc common	WHITE	8...34 vdc***	14...29 vdc common	RED	8...34 vdc***	14...29 vdc common
B	4...20 mA out	0...20 mA out	BLACK	4...20 mA out	0...20 mA out	BLACK	4...20 mA out	n/a
C	-	-	GREEN	case ground	case ground	WHITE	n/a	n/a
D	case ground	-				GREEN	case ground	0...20 mA out

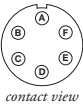





contact view

Notes: { * -Test pressure: 100 feet [30 meters] H₂O (40 PSID); Test Medium: Air; Duration: 2 hours.
** -NEMA 4X applies to stainless steel enclosure only.
*** -14-32 VDC for hazardous area option.

Output Signal Selection:

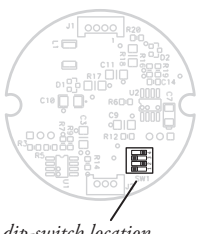
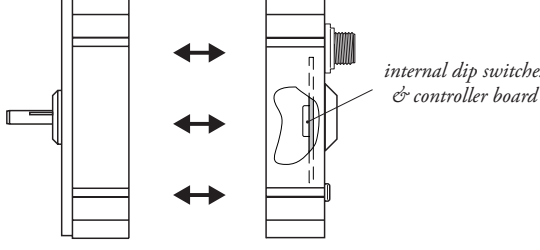
The output signal direction can be reversed at any time by simply changing the dip-switch settings found on the internal signal board. After the settings have been changed, adjustment of the Zero and Span trimpots will be required to precisely match signal values to the beginning and end points of the stroke.

output signal	switch setting	signal board	
<p>0...20 mA or 4...20 mA</p> 		 <p>dip-switch location</p>	 <p>internal dip switches & controller board</p> <p>To gain access to the signal board, remove four Allen-Head Screws and separate the two case halves.</p>
<p>20...0 mA or 20...4 mA</p> 			

version: 6.0 last updated: May 21, 2013