

DeviceNET®

Ranges: 0-2 to 0-50 inches

Compact Size • OEM Applications

# PT1DN

**Specification Summary:**

**GENERAL**

Full Stroke Ranges ..... 0-2 to 0-50 inches  
 Electrical Interface ..... CANbus ISO 11898  
 Protocol ..... DeviceNET version 2.0  
 Accuracy ..... ± 0.25% to ± 0.10% full stroke  
 Repeatability ..... ± 0.02% full stroke  
 Resolution ..... ± 0.003% full stroke  
 Measuring Cable ..... .019-in. dia. nylon-coated stainless steel  
 Enclosure Material ..... glass-filled polycarbonate and black anodized aluminum  
 Sensor ..... plastic-hybrid precision potentiometer  
 Potentiometer Cycle Life ..... see ordering information  
 Maximum Retraction Acceleration ..... see ordering information  
 Weight ..... 1 lb. max.

**ELECTRICAL**

Input Voltage ..... .bus powered  
 Input Current ..... 40 mA  
 Address Setting/Node ID ..... 0...63 set via DIP switches –default setting: 63  
 Baud Rate ..... 125K, 250K or 500K set via DIP switches  
 EDS File ..... available @ <http://www.celesco.com/download>

**ENVIRONMENTAL**

Environmental Suitability ..... NEMA 4, IP 67  
 Operating Temperature ..... 0° to 185°F (-17° to 85°C)  
 Vibration ..... up to 10 G's to 2000 Hz maximum

Outline Drawing

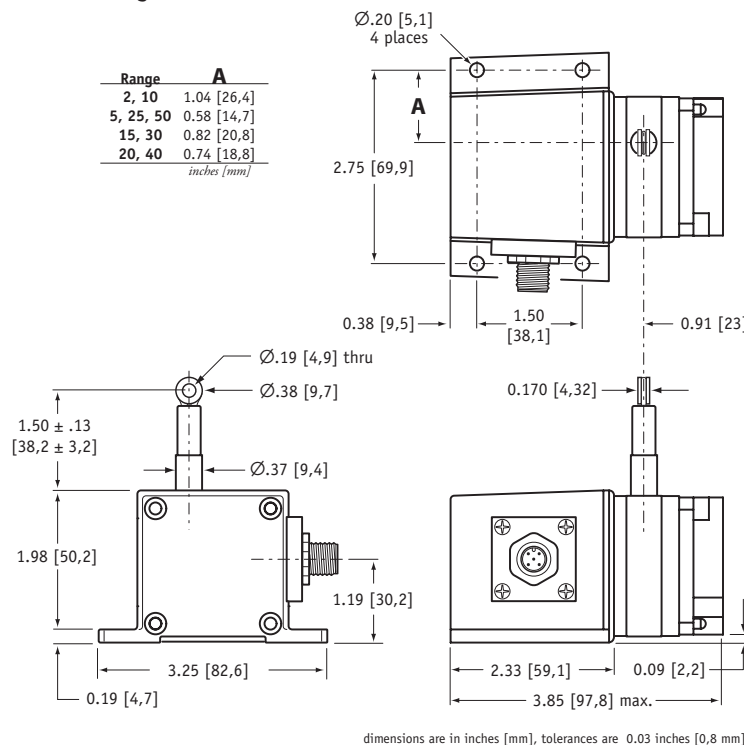

The PT1DN communicates to your PLC over DeviceNET® and provides a precision position feedback signal for full-scale measurement ranges from 2 to 50 inches. Because the PT1DN uses a potentiometer as its sensing element, the position signal is “absolute” and does not have to be reset to a “home” position upon startup.

The PT1DN is part of Celesco’s compact line of cable-extension transducers and is perfect where space is limited.

Output Signal

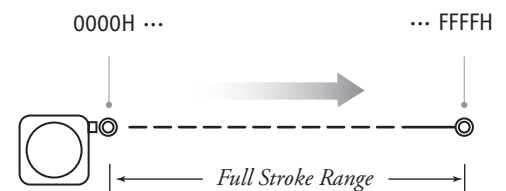

**I/O Format**

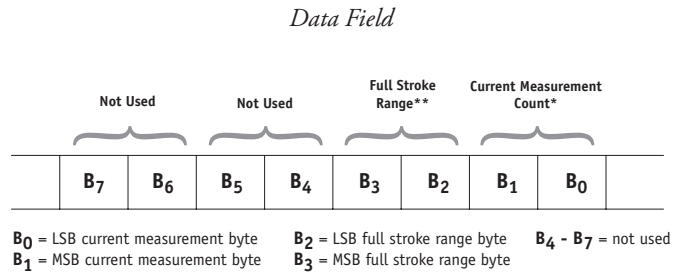
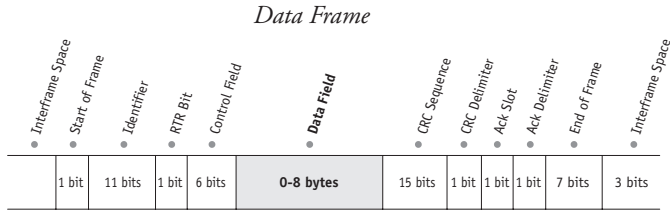

**\*Current Measurement Count**

The **Current Measurement Count (CMC)** is the output data that indicates the present position of the measuring cable.

The CMC is a 16-bit value that occupies the first two bytes (B<sub>0</sub> and B<sub>1</sub>) of the data field. B<sub>0</sub> is the LSB (least significant byte) and B<sub>1</sub> is the MSB (most significant byte).

The CMC starts at 0000H with the measuring cable fully retracted and continues upward to the end of the stroke range stopping at FFFFH. This holds true for all ranges.

**\*\*Full Stroke Range**

The **Full Stroke Range (FSR)** is a 16-bit value in the data field that expresses the full range of the sensor in inches. This value can be used to convert the actual count to units of measurement should the application require it.

The full stroke measurement range occupies the second two bytes (B<sub>2</sub> and B<sub>3</sub>) of the data field.

B<sub>2</sub> is the LSB (least significant byte) and B<sub>3</sub> is the MSB (most significant byte).

This value is expressed in inches.

Example:

Hex Value	Decimal Equivalent	Full Stroke Range
001E	30	30 inches

**Converting CMC to Inches**

If required, the CMC can easily be converted to a linear measurement expressed in inches instead of just counts.

This is accomplished by first dividing the CMC by 65,535 (total counts over the range) and then multiplying that value by the FSR:

$$\left( \frac{\text{CMC}}{65,535} \right) \times \text{FSR}$$

Example:

If the full stroke range is **30 inches** and the current position is **OFF2 Hex** (4082 Decimal) then,

$$\left( \frac{4082}{65,535} \right) \times 30.00 \text{ inches} = 1.87 \text{ inches}$$

**Address Setting (Node ID), Baud Rate and Bus Termination Settings**

**Address Setting (Node ID)**

The Address Setting (Node ID) is set via 6 switches located on the 8-pole DIP switch found on the DeviceNET controller board located inside the transducer.

The DIP switch settings are binary starting with switch number 1 (= 2<sup>0</sup>) and ending with switch number 6 (= 2<sup>5</sup>).

DIP-1 (2 <sup>0</sup> )	DIP-2 (2 <sup>1</sup> )	DIP-3 (2 <sup>2</sup> )	DIP-4 (2 <sup>3</sup> )	DIP-5 (2 <sup>4</sup> )	DIP-6 (2 <sup>5</sup> )	address (decimal)
0	0	0	0	0	0	0
1	0	0	0	0	0	1
0	1	0	0	0	0	2
...	...	...	...	...	...	...
1	1	1	1	1	1	63



**Baud Rate**

The transmission baud rate may be either factory preset at the time of order or set manually at the time of installation.

The baud rate can be set using switches 7 & 8 on the 8-pole DIP switch found on the DeviceNET controller board located inside the transducer.

DIP-7	DIP-8	baud rate
0	0	125k
1	0	250k
0	1	500k
1	1	125k



**Bus Termination**

The setting of the internal bus termination resistor may be specified upon order or manually changed by the end user at the time of installation.

The bus termination resistor is activated setting switches 1 & 2 on the 2-pole DIP switch (located on the internal DeviceNET controller board) to the "ON" position.

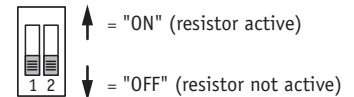

**DeviceNET Controller Board and DIP Switch Location**

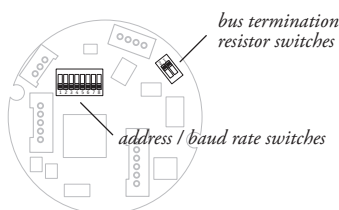

to gain access to the controller board, remove four Allen-Head Screws and remove rear cover.

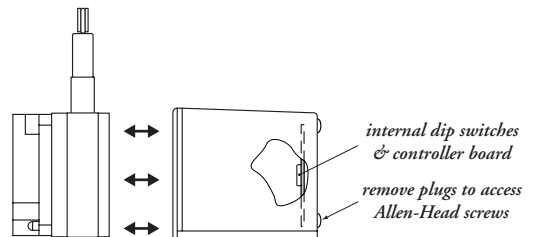

**Ordering Information:**

**Model Number:**

**PT1DN** -      -      -      -      -      -       
order code:                      R                      A                      B                      C                      D                      E

Sample Model Number:

**PT1DN - 30 - UP - SG - 500 - TR - SC5**

- R** range: 30 inches
- A** measuring cable exit: up
- B** cable guide: spring-loaded guide
- C** baud rate: 500 k bits/sec.
- D** terminating resistor: yes
- E** electrical connection: 5 meter cordset with straight plug

**Full Stroke Range:**

<b>R</b> order code:	2	5	10	15	20	25	30	40	50
full stroke range, min:	2 in.	5 in.	10 in.	15 in.	20 in.	25 in.	30 in.	40 in.	50 in.
accuracy (% of f.s.):	0.25%		0.15%			0.10%			
potentiometer cycle life:	2,500,000 cycles		500,000 cycles			250,000 cycles			
cable tension (20%):	12 oz.	5 oz.	12 oz.	9 oz.	6 oz.	5 oz.	9 oz.	6 oz.	5 oz.
maximum cable acceleration:	11 G's	3 G's	11 G's	5 G's	4 G's	3 G's	5 G's	4 G's	3 G's

**Cable Exit:**

**A** order code: **UP** **DN** **FR** **BK**  
 direction: up down front back

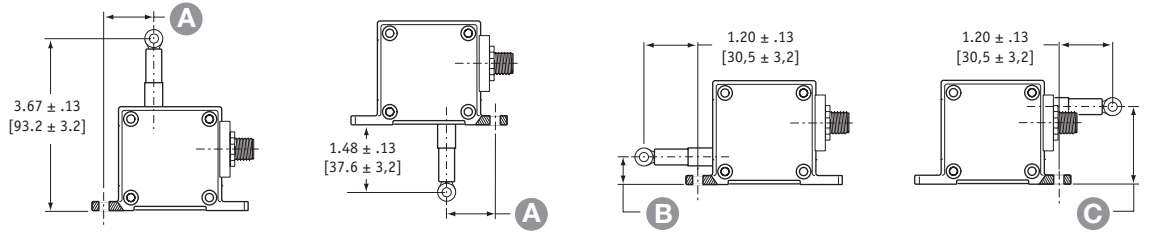

	2	5	10	15	20	25	30	40	50
<b>A</b>	1.04 in. 26,4 mm	0.58 in. 14,7 mm	1.04 in. 26,4 mm	0.82 in. 20,8 mm	0.74 in. 18,8 mm	0.58 in. 14,7 mm	0.82 in. 20,8 mm	0.74 in. 18,8 mm	0.58 in. 14,7 mm
<b>B</b>	0.75 in. 19,1 mm	0.29 in. 6,1 mm	0.75 in. 19,1 mm	0.53 in. 13,5 mm	0.45 in. 11,5 mm	0.29 in. 6,1 mm	0.53 in. 13,5 mm	0.45 in. 11,5 mm	0.29 in. 6,1 mm
<b>C</b>	1.43 in. 36,3 mm	1.89 in. 48,0 mm	1.43 in. 36,3 mm	1.65 in. 41,9 mm	1.73 in. 43,9 mm	1.89 in. 48,0 mm	1.65 in. 41,9 mm	1.73 in. 43,9 mm	1.89 in. 48,0 mm

**Cable Guide:**

**B** order code: **blank** **SG**  
 standard cable guide spring-loaded guide

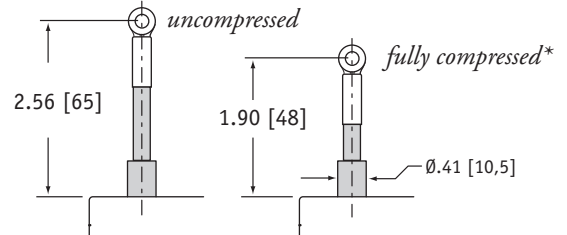
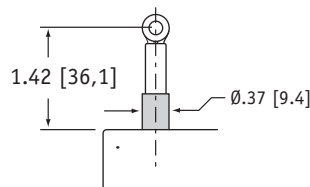

\*note: start of full stroke range begins at full compression point (except 2-inch and 5-inch ranges).

**Ordering Information (cont.)**



**Baud Rate:**

④ order code:	<b>125</b>	<b>250</b>	<b>500</b>
	125 kbaud	250 kbaud	500 kbaud

**Terminating Resistor:**

① order code:	<b>TR</b>	<b>NR</b>
	terminating resistor	no terminating resistor

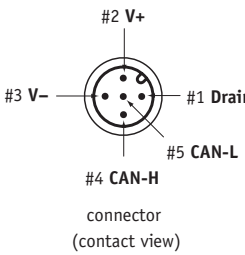
**Electrical Connection:**

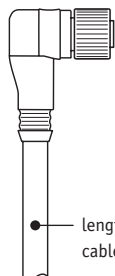
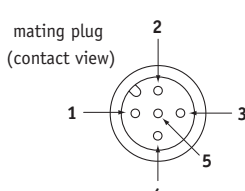
⑤ order code:	<b>blank</b>	<b>MC5</b>	<b>SC5</b>	<b>NC5</b>																		
	5-pin micro-connector <i>(no mating plug supplied)</i>	5-pin micro-connector w/ mating plug	5-pin micro-connector and 5 meter length cordset w/straight mating plug	5-pin micro-connector and 5 meter length cordset w/90° mating plug																		
	 <p>connector (contact view)</p>	 <p>0.16" - 0.32" OD Cable (THIN)</p>	 <p>length: 16ft [5M] cable: Thin</p>	 <p>length: 16ft [5M] cable: Thin</p>																		
		 <p>mating plug (contact view)</p>																				
			<table border="1"> <thead> <tr> <th>pin</th> <th>signal</th> <th>wire color</th> </tr> </thead> <tbody> <tr> <td>1</td> <td>drain</td> <td>brown</td> </tr> <tr> <td>2</td> <td>V+</td> <td>white</td> </tr> <tr> <td>3</td> <td>V-</td> <td>blue</td> </tr> <tr> <td>4</td> <td>Can-H</td> <td>black</td> </tr> <tr> <td>5</td> <td>Can-L</td> <td>grey</td> </tr> </tbody> </table>	pin	signal	wire color	1	drain	brown	2	V+	white	3	V-	blue	4	Can-H	black	5	Can-L	grey	
pin	signal	wire color																				
1	drain	brown																				
2	V+	white																				
3	V-	blue																				
4	Can-H	black																				
5	Can-L	grey																				

version: 4.0 last updated: April 28, 2010

