



Typical Applications

The HMC524LC3B is ideal for:

- Point-to-Point Radios
- Point-to-Multi-Point Radios & VSAT
- Test Equipment & Sensors
- Military End Use

Features

- Wide IF Bandwidth: DC - 4.5 GHz
- Image Rejection: 20 dB
- LO to RF Isolation: 45 dB
- High Input IP3: +20 dBm
- RoHS Compliant 3x3 mm SMT Package

Functional Diagram

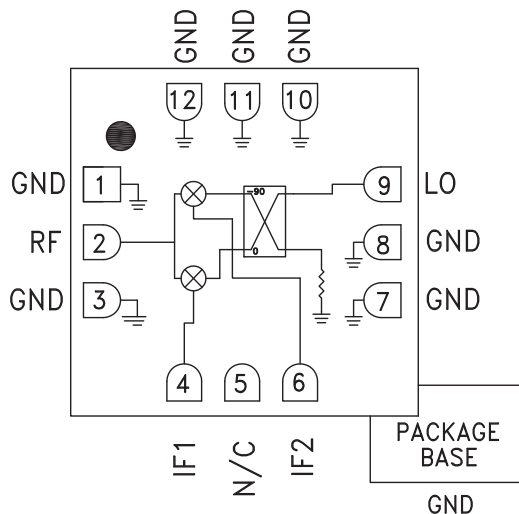

General Description

The HMC524LC3B is a compact I/Q MMIC mixer which can be used as either an Image Reject Mixer or a Single Sideband Upconverter. The chip utilizes standard Hittite mixer cells and a 90 degree hybrid fabricated in a GaAs MESFET process. A low frequency quadrature hybrid was used to produce a 100 MHz USB IF output. This product is a much smaller alternative to hybrid style Image Reject mixers and single sideband upconverter assemblies. The HMC524LC3B eliminates the need for wirebonding, allowing the use of surface mount techniques.

Electrical Specifications, $T_A = +25^\circ \text{C}$, IF= 100 MHz, LO = +17 dBm*

Parameter	Min.	Typ.	Max.	Units
Frequency Range, RF/LO	22 - 32			GHz
Frequency Range, IF	DC - 4.5			GHz
Conversion Loss (As IRM)		10	13	dB
Image Rejection	18	20		dB
1 dB Compression (Input)		+16		dBm
LO to RF Isolation	35	40		dB
LO to IF Isolation	20	30		dB
IP3 (Input)		+20		dBm
Amplitude Balance		±0.5		dB
Phase Balance		±2.5		Deg

* Unless otherwise noted, all measurements performed as downconverter.



HMC524LC3B

GaAs MMIC I/Q MIXER 22 - 32 GHz

Data Taken As IRM With External IF Hybrid

Conversion Gain vs. Temperature

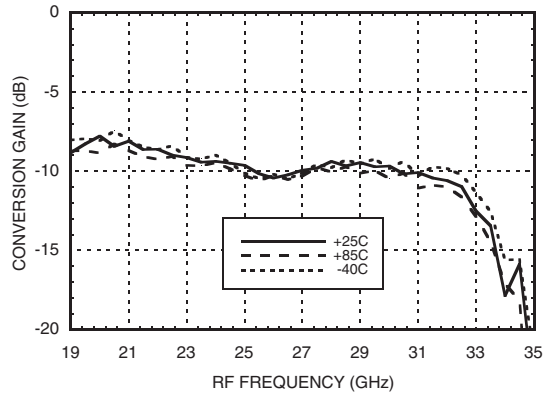
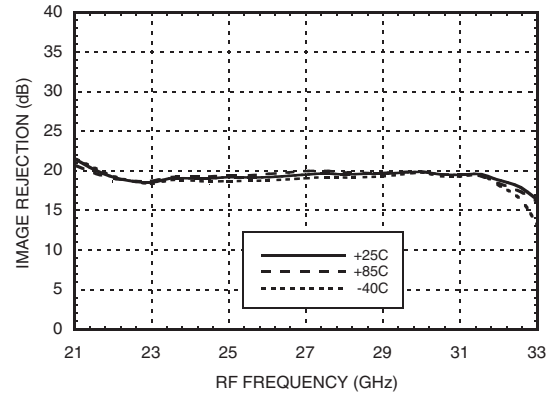
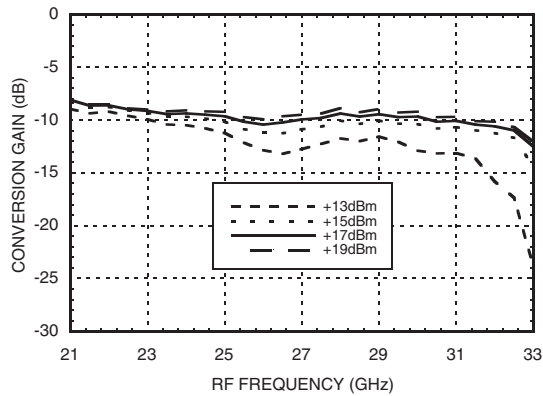

Image Rejection vs. Temperature



Conversion Gain vs. LO Drive



Return Loss

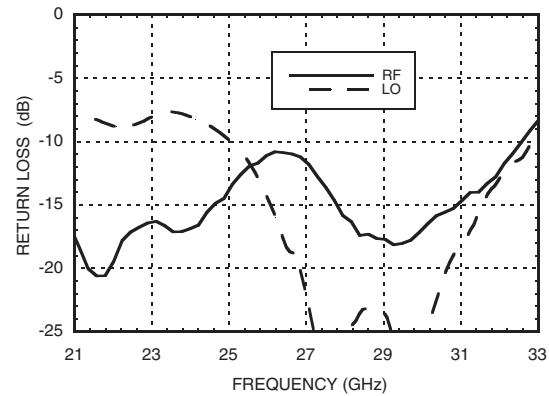

Input P1dB vs. Temperature

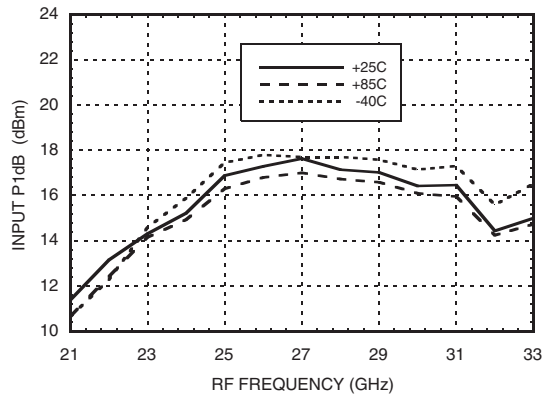

Input IP3 vs. LO Drive

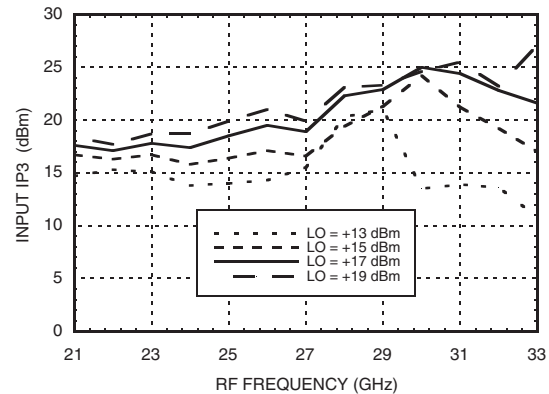



HMC524LC3B

GaAs MMIC I/Q MIXER 22 - 32 GHz

Data Taken As IRM With External IF Hybrid

Isolations

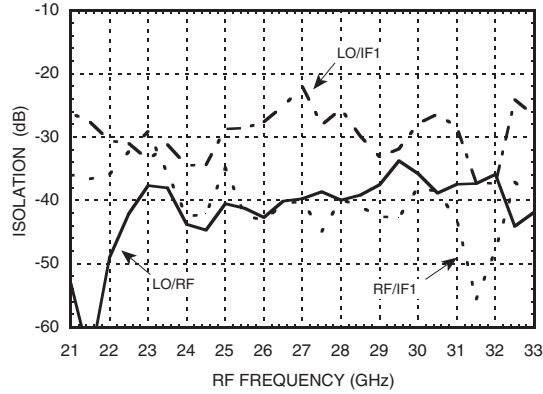

IF Bandwidth

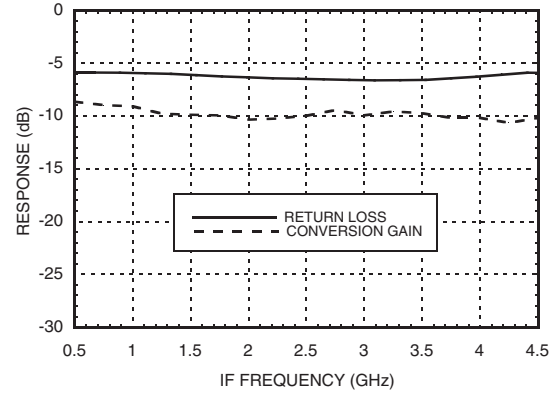

Amplitude Balance vs. LO Drive

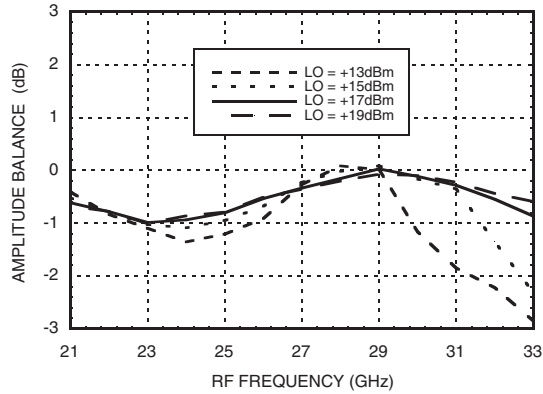

Phase Balance vs. LO Drive

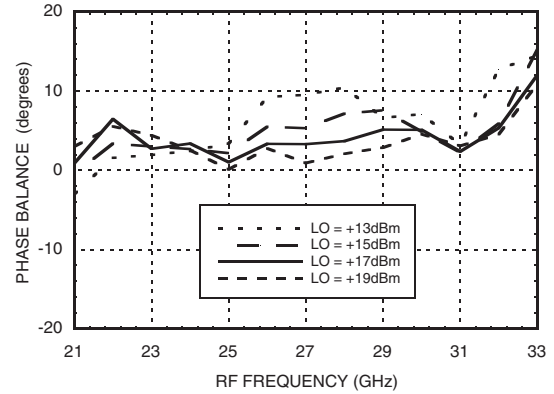

Upconverter Performance Conversion Gain vs. LO Drive

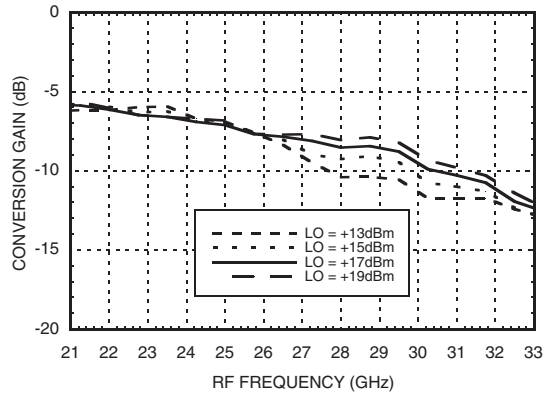

Upconverter Performance Sideband Rejection vs. LO Drive

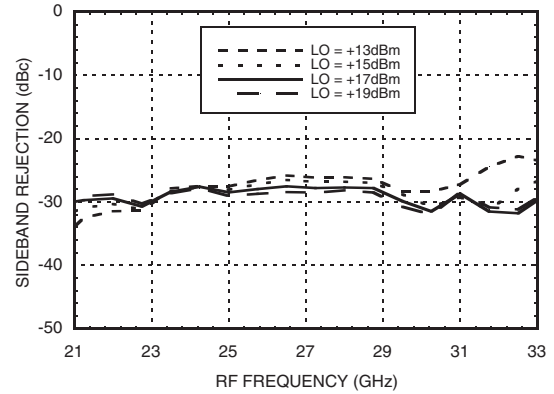



Absolute Maximum Ratings

RF / IF Input	+20 dBm
LO Drive	+27 dBm
Channel Temperature	150°C
Continuous Pdiss (T=85°C) (derate 9.8 mW/°C above 85°C)	340 mW
Thermal Resistance (R _{TH}) (junction to die bottom)	191.5 °C/W
Storage Temperature	-65 to +150 °C
Operating Temperature	-55 to +85 °C
ESD Sensitivity (HBM)	Class 1A

MxN Spurious Outputs

mRF	nLO				
	0	1	2	3	4
0	xx	-13	27	xx	xx
1	18	0	35	52	xx
2	76	74	87	74	82
3	xx	83	87	77	87
4	xx	xx	82	87	87

RF = 24.5 GHz @ -10 dBm
LO = 24.4 GHz @ 17 dBm
Data taken without IF hybrid
All values in dBc below IF power level



ELECTROSTATIC SENSITIVE DEVICE
OBSERVE HANDLING PRECAUTIONS

Outline Drawing

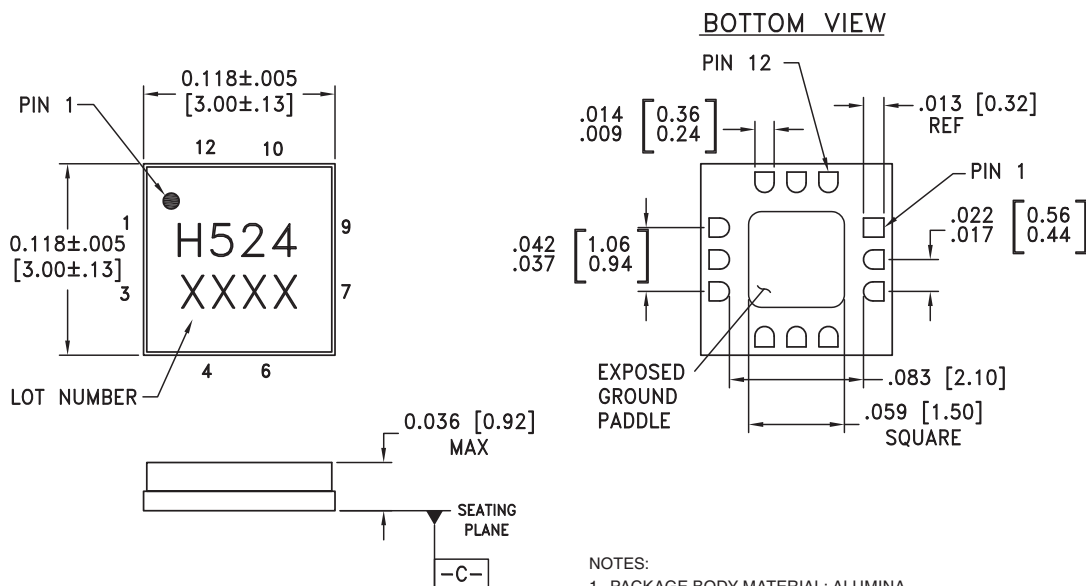

- NOTES:
1. PACKAGE BODY MATERIAL: ALUMINA
 2. LEAD AND GROUND PADDLE PLATING: 30 - 80 MICROINCHES GOLD OVER 50 MICROINCHES MINIMUM NICKLE
 3. DIMENSIONS ARE IN INCHES [MILLIMETERS]
 4. LEAD SPACING TOLERANCE IS NON-CUMULATIVE
 5. PACKAGE WARP SHALL NOT EXCEED 0.05mm DATUM
 6. ALL GROUND LEADS AND GROUND PADDLE MUST BE SOLDERED TO PCB RF GROUND
 7. CLASSIFIED AS A MOISTURE SENSITIVITY LEVEL (MSL) 1.



Pin Descriptions

Pin Number	Function	Description	Interface Schematic
1, 3, 7, 8, 10, 11, 12	GND	The backside of the die must be connected to RF/DC ground.	
2	RF	This pad is AC coupled and matched to 50 Ohms.	
4	IF1	This pad is DC coupled. For applications not requiring operation to DC, this port should be DC blocked externally using a series capacitor whose value has been chosen to pass the necessary IF frequency range. For operation to DC, this pad must not source/sink more than 3mA of current or die non-function and possible die failure will result.	
6	IF2		
5	N/C	No connection required. These pins may be connected to RF/DC ground without affecting performance	
9	LO	This pad is DC coupled and matched to 50 Ohms.	

Evaluation PCB

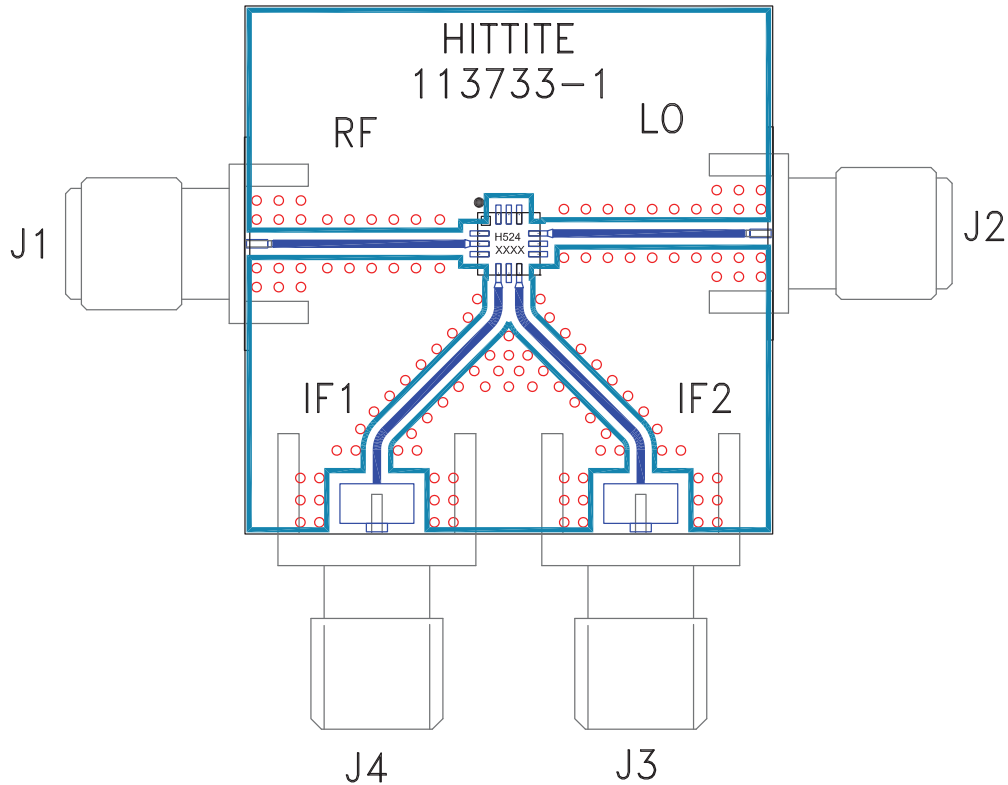

List of Materials for Evaluation PCB 109998 [1]

Item	Description
J1 - J2	PCB Mount K RF Connector, SRI
J3 - J4	PCB Mount SMA Connector, Johnson
U1	HMC524LC3B Mixer
PCB [2]	109996 Evaluation Board

[1] Reference this number when ordering complete evaluation PCB

[2] Circuit Board Material: Rogers 4350

The circuit board used in the final application should use RF circuit design techniques. Signal lines should have 50 ohm impedance while the package ground leads and exposed paddle should be connected directly to the ground plane similar to that shown. A sufficient number of via holes should be used to connect the top and bottom ground planes. The evaluation circuit board shown is available from Hittite upon request.