

**GaAs PHEMT MMIC LOW NOISE  
 HIGH IP3 AMPLIFIER, 12 - 17 GHz**

**Typical Applications**

The HMC490 is ideal for use as either a LNA or driver amplifier for:

- Point-to-Point Radios
- Point-to-Multi-Point Radios
- VSAT
- Military & Space

**Features**

- Noise Figure: 2 dB
- Output P1dB: +26 dBm
- Gain: 27 dB
- Output IP3: +35 dBm
- Supply Voltage: +5V
- 50 Ohm Matched Input/Output
- Die Size: 2.78 x 1.46 x 0.1 mm

**Functional Diagram**

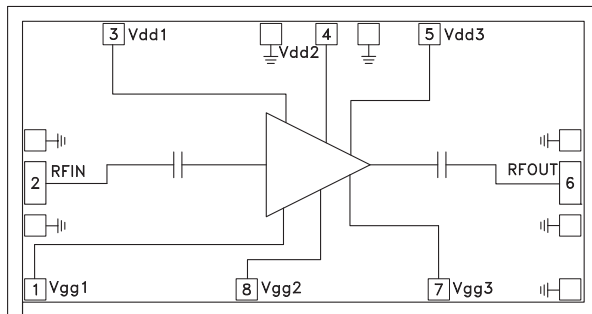

**General Description**

The HMC490 is a high dynamic range GaAs PHEMT MMIC Low Noise Amplifier which operates between 12 and 17 GHz. The HMC490 provides 27 dB of gain, 2 dB noise figure and an output IP3 of 35 dBm from a +5V supply voltage. The amplifier chip can easily be integrated into Multi-Chip-Modules (MCMs) due to its small size. All data is tested with the chip in a 50 Ohm test fixture connected via 0.025mm (1 mil) diameter wire bonds of minimal length 0.31mm (12 mils).

**Electrical Specifications,  $T_A = +25^\circ C$ ,  $V_{dd} = 5V$ ,  $I_{dd} = 200 mA^*$**

Parameter	Min.	Typ.	Max.	Min.	Typ.	Max.	Units
Frequency Range	12 - 14		14 - 17				GHz
Gain	24	26.5		24	27		dB
Gain Variation Over Temperature		0.03	0.04		0.03	0.04	dB/ °C
Noise Figure		2.5			2.0		dB
Input Return Loss		8			12		dB
Output Return Loss		8			9		dB
Output Power for 1 dB Compression (P1dB)	22	25		23	26		dBm
Saturated Output Power (Psat)		27			28		dBm
Output Third Order Intercept (IP3)		32			35		dBm
Supply Current (Idd)(Vdd = 5V, Vgg = -0.8V Typ.)		200	250		200	250	mA

\* Adjust Vgg between -2.0 to 0V to achieve Idd = 200 mA typical.

**GaAs PHEMT MMIC LOW NOISE  
HIGH IP3 AMPLIFIER, 12 - 17 GHz**

**Broadband Gain & Return Loss**

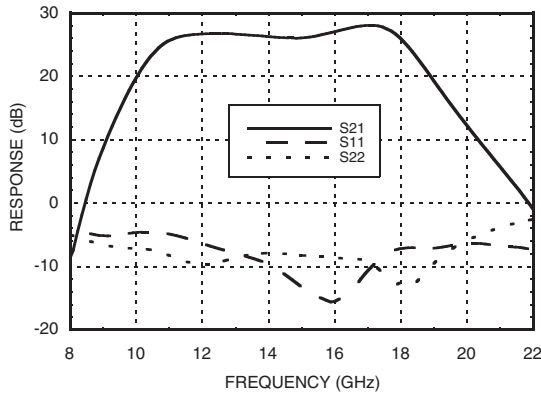

**Gain vs. Temperature**

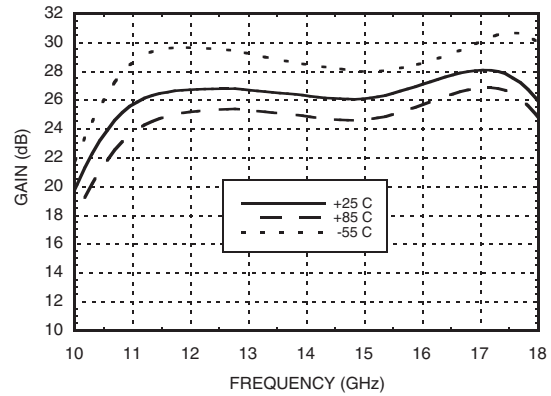

**Input Return Loss vs. Temperature**

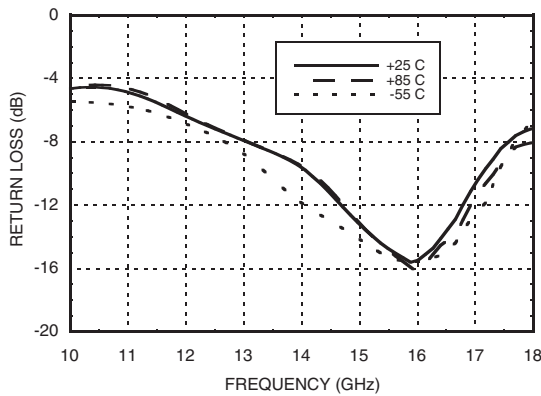

**Output Return Loss vs. Temperature**

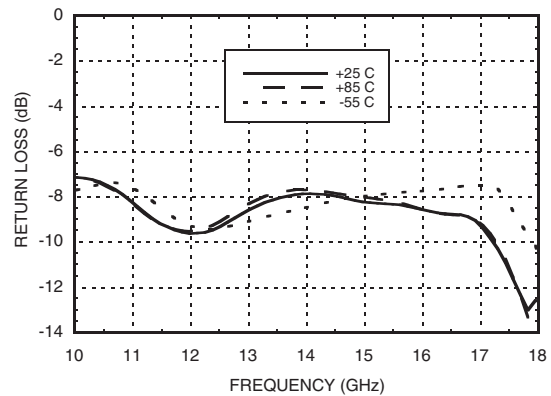

**Noise Figure vs. Temperature**

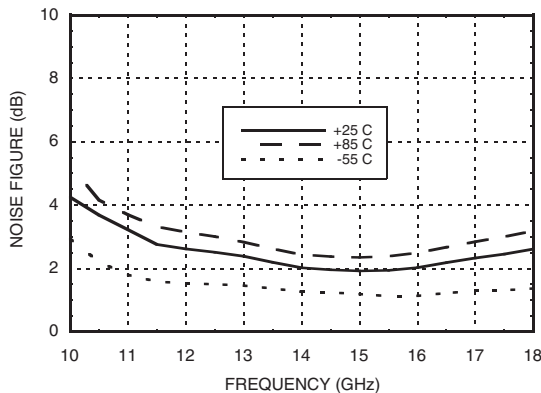

**Output IP3 vs. Temperature**

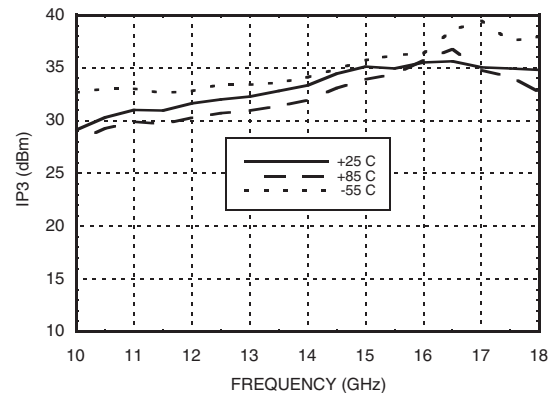

**GaAs PHEMT MMIC LOW NOISE  
HIGH IP3 AMPLIFIER, 12 - 17 GHz**

1  
LOW NOISE AMPLIFIERS - CHIP

**P1dB vs. Temperature**

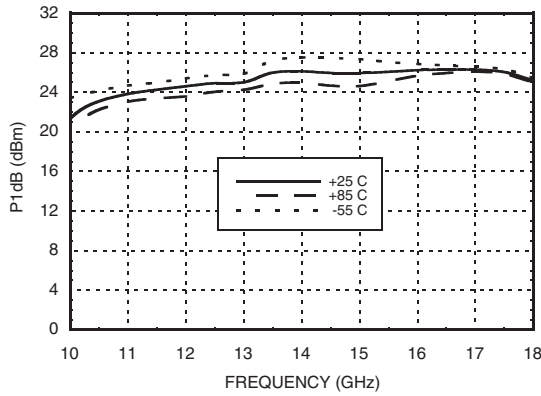

**Psat vs. Temperature**

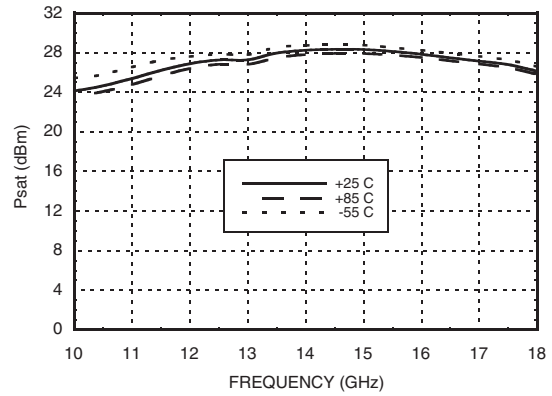

**Gain & Noise Figure vs. Supply Voltage @ 14 GHz, Idd= 200 mA**

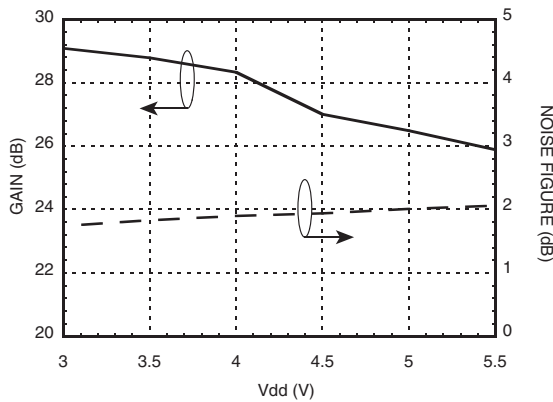

**Power Compression @ 14 GHz**

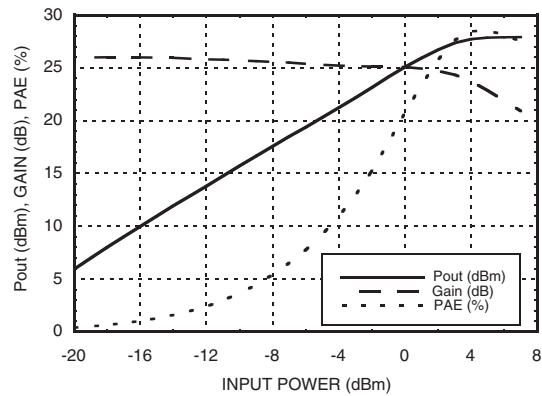

**Reverse Isolation vs. Temperature**

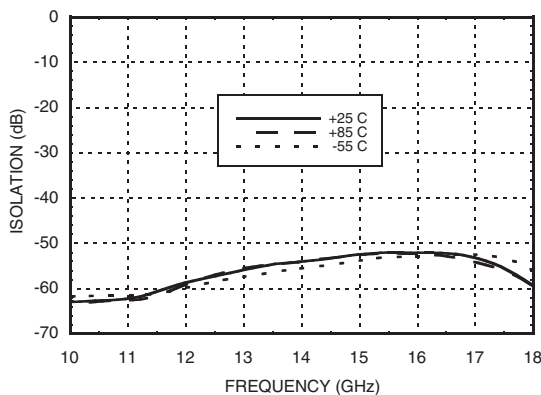

**Gain, Noise Figure & Output IP3 vs. Supply Current @ 14 GHz, Vdd= 5V\***

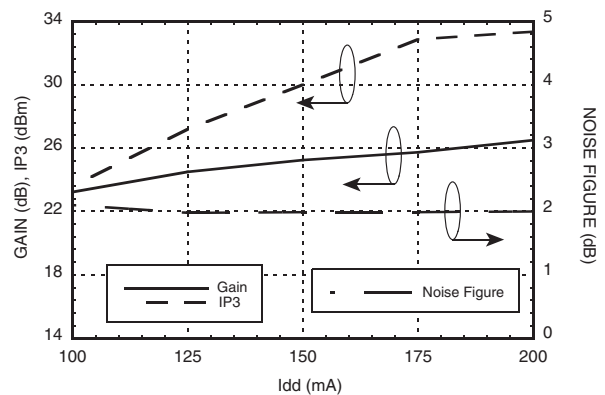

\* Idd is controlled by varying Vgg



**GaAs PHEMT MMIC LOW NOISE  
HIGH IP3 AMPLIFIER, 12 - 17 GHz**

**Absolute Maximum Ratings**

Drain Bias Voltage (Vdd1, Vdd2, Vdd3)	+5.5 Vdc
Gate Bias Voltage (Vgg1, Vgg2, Vgg3)	-4 to 0 Vdc
RF Input Power (RFIN)(Vdd = +5 Vdc)	+10 dBm
Channel Temperature	175 °C
Continuous Pdiss (T= 85 °C) (derate 29 mW/°C above 85 °C)	2.65 W
Thermal Resistance (channel to die bottom)	34 °C/W
Storage Temperature	-65 to +150 °C
Operating Temperature	-55 to +85 °C

**Typical Supply Current vs. Vdd**

Vdd (Vdc)	Idd (mA)
+4.5	191
+5.0	200
+5.5	208
+3.0	189
+3.5	200
+4.0	208

Note: Amplifier will operate over full voltage ranges shown above. Vgg adjusted to achieve Idd= 200 mA at +5.0V and +3.5V.



ELECTROSTATIC SENSITIVE DEVICE  
OBSERVE HANDLING PRECAUTIONS

**Outline Drawing**

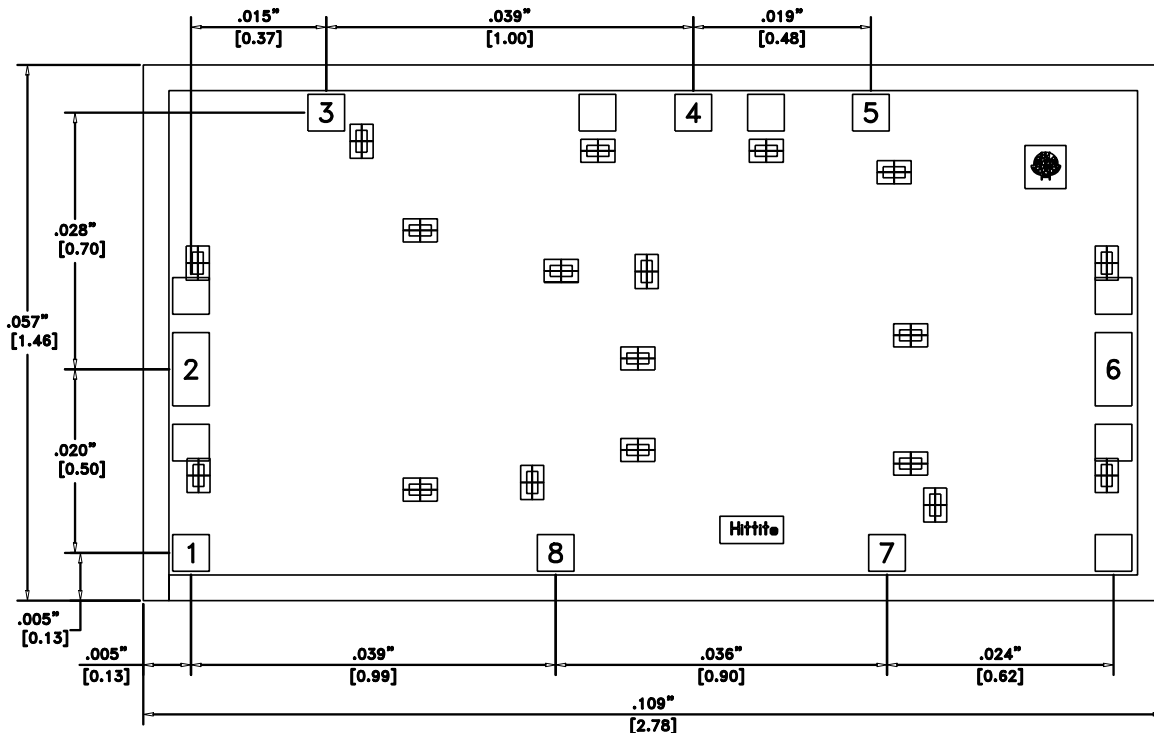

**Die Packaging Information** [1]

Standard	Alternate
GP-2 (Gel Pack)	[2]

[1] Refer to the "Packaging Information" section for die packaging dimensions.



[2] For alternate packaging information contact Hittite Microwave Corporation.

NOTES:

- ALL DIMENSIONS ARE IN INCHES [MM]
- DIE THICKNESS IS .004"
- TYPICAL BOND IS .004" SQUARE
- BACKSIDE METALLIZATION: GOLD
- BOND PAD METALLIZATION: GOLD
- BACKSIDE METAL IS GROUND.
- CONNECTION NOT REQUIRED FOR UNLABELED BOND PADS.

**GaAs PHEMT MMIC LOW NOISE  
HIGH IP3 AMPLIFIER, 12 - 17 GHz**

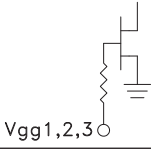
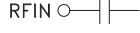
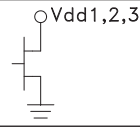
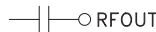
**Pad Descriptions**

Pad Number	Function	Description	Interface Schematic
1,8, 7	Vgg1, 2, 3	Gate control for amplifier. Adjust to achieve Id of 200 mA. Please follow "MMIC Amplifier Biasing Procedure" Application Note. External bypass capacitors of 100 pF and 0.01 μF are required.	
2	RFIN	This pad is AC coupled and matched to 50 Ohms.	
3, 4, 5	Vdd1, 2, 3	Power Supply Voltage for the amplifier. External bypass capacitors of 100 pF and 0.01 μF are required.	
6	RFOUT	This pad is AC coupled and matched to 50 Ohms.	
Die Bottom	GND	Die Bottom must be connected to RF/DC ground.	

**Assembly Diagram**

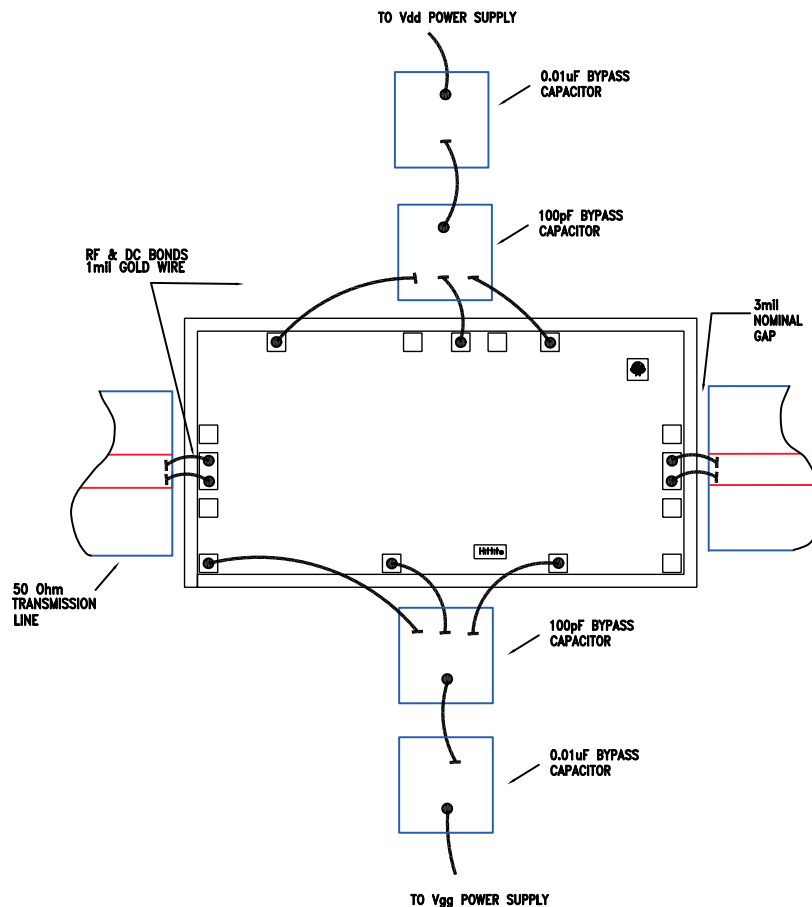

**GaAs PHEMT MMIC LOW NOISE  
HIGH IP3 AMPLIFIER, 12 - 17 GHz**

**Mounting & Bonding Techniques for Millimeterwave GaAs MMICs**

The die should be attached directly to the ground plane eutectically or with conductive epoxy (see HMC general Handling, Mounting, Bonding Note).

50 Ohm Microstrip transmission lines on 0.127mm (5 mil) thick alumina thin film substrates are recommended for bringing RF to and from the chip (Figure 1). If 0.254mm (10 mil) thick alumina thin film substrates must be used, the die should be raised 0.150mm (6 mils) so that the surface of the die is coplanar with the surface of the substrate. One way to accomplish this is to attach the 0.102mm (4 mil) thick die to a 0.150mm (6 mil) thick molybdenum heat spreader (moly-tab) which is then attached to the ground plane (Figure 2).

Microstrip substrates should be brought as close to the die as possible in order to minimize bond wire length. Typical die-to-substrate spacing is 0.076mm to 0.152 mm (3 to 6 mils).

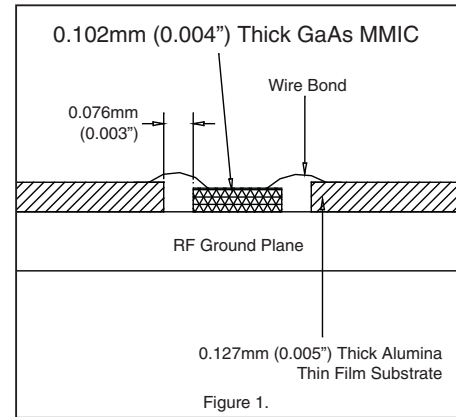

**Handling Precautions**

Follow these precautions to avoid permanent damage.

**Storage:** All bare die are placed in either Waffle or Gel based ESD protective containers, and then sealed in an ESD protective bag for shipment. Once the sealed ESD protective bag has been opened, all die should be stored in a dry nitrogen environment.

**Cleanliness:** Handle the chips in a clean environment. DO NOT attempt to clean the chip using liquid cleaning systems.

**Static Sensitivity:** Follow ESD precautions to protect against ESD strikes.

**Transients:** Suppress instrument and bias supply transients while bias is applied. Use shielded signal and bias cables to minimize inductive pick-up.

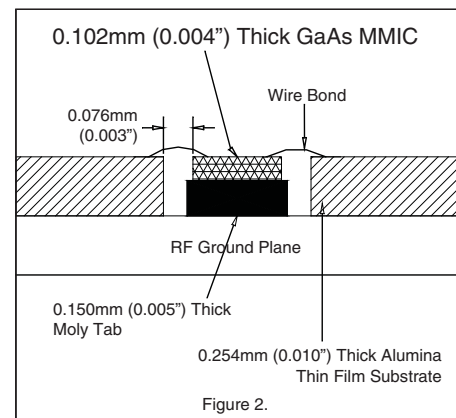

**General Handling:** Handle the chip along the edges with a vacuum collet or with a sharp pair of bent tweezers. The surface of the chip has fragile air bridges and should not be touched with vacuum collet, tweezers, or fingers.

**Mounting**

The chip is back-metallized and can be die mounted with AuSn eutectic preforms or with electrically conductive epoxy. The mounting surface should be clean and flat.

**Eutectic Die Attach:** A 80/20 gold tin preform is recommended with a work surface temperature of 255 °C and a tool temperature of 265 °C. When hot 90/10 nitrogen/hydrogen gas is applied, tool tip temperature should be 290 °C. DO NOT expose the chip to a temperature greater than 320 °C for more than 20 seconds. No more than 3 seconds of scrubbing should be required for attachment.

**Epoxy Die Attach:** Apply a minimum amount of epoxy to the mounting surface so that a thin epoxy fillet is observed around the perimeter of the chip once it is placed into position. Cure epoxy per the manufacturer's schedule.

**Wire Bonding**

Ball or wedge bond with 0.025mm (1 mil) diameter pure gold wire. Thermosonic wirebonding with a nominal stage temperature of 150 °C and a ball bonding force of 40 to 50 grams or wedge bonding force of 18 to 22 grams is recommended. Use the minimum level of ultrasonic energy to achieve reliable wirebonds. Wirebonds should be started on the chip and terminated on the package or substrate. All bonds should be as short as possible <0.31mm (12 mils).