

## Specifications and Ordering Information

### 3300 5mm Transducer

Patents: 5,016,343; 5,126,664; 5,351,388; and 5,685,884

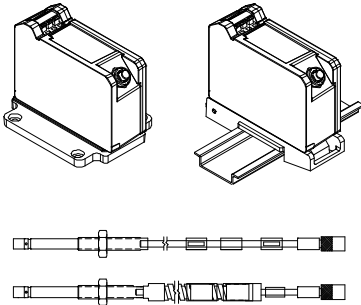

## Description

### Transducer System

The 3300 5mm Proximity Transducer System consists of:

- a 3300 5 mm probe <sup>1,2</sup>
- a 3300 XL extension cable (ref 141194-01)
- a 3300 Proximator® Sensor <sup>3,4,5</sup> (ref 141194-01)

When combined with a 3300 XL Proximator® Sensor and XL extension cable, the system provides an output voltage directly proportional to the distance between the probe tip and the observed conductive surface. It is capable of both static (position) and dynamic (vibration) measurements. Its primary use is for vibration and position measurement applications on fluid-film bearing machines, as well as Keyphasor® measurement and speed measurement applications <sup>6</sup>.

The system provides an accurate, stable signal output over a wide temperature range. All 3300 XL Proximity Transducer Systems achieve this level of performance while allowing complete interchangeability of probe, extension cable, and Proximator® Sensors. This eliminates the need for individual component matching or bench calibration.

### Proximity Probe

The 3300 5 mm probe reflects improvements over previous designs. A patented TipLoc™ molding method provides a more robust bond between the probe tip and the probe body.

### Connectors

The 3300 5mm probe and 3300 XL extension cable have corrosion-resistant, gold-plated brass ClickLoc™ connectors that require only finger-tight torque (connectors will "click"). The specially engineered locking mechanism prevents the connectors from loosening. These connectors do not require any special tools for installation or removal.



3300 5mm Probes and XL Extension Cables can be ordered with connector protectors already installed, or the connector protectors supplied separately for installation in the field (such as when the cable must be run through restrictive conduit). Connector protectors are recommended for all installations and provide increased environmental protection<sup>7</sup>.

**Notes:**

1. A 5 mm probe uses smaller physical packaging while providing the same linear range as a 3300 XL 8 mm probe (ref 141194-01); however, it does not permit reduced sideview clearances or tip-to-tip spacing requirements compared to an XL 8 mm probe. It is used when physical (not electrical) constraints preclude the use of an 8 mm probe, such as mounting between thrust bearing pads or other constrained spaces. When narrow sideview probes are required, use the 3300 XL NSv™ probe and extension cable with the 3300 XL NSv Proximito<sup>®</sup> Sensor (refer to Specifications and Ordering Information p/n 147385-01).
2. XL 8 mm probes provide a thicker encapsulation of the probe coil in the molded PPS plastic probe tip. This results in a more rugged probe. The larger diameter of the probe body also provides a stronger, more robust case. Bently Nevada recommends the use of XL 8 mm probes when possible to provide optimal robustness against physical abuse.
3. A 3300 XL Proximito<sup>®</sup> Sensor is available and provides many improvements over the non-XL version. It is electrically and mechanically interchangeable with the non-XL version. Although the packaging of the 3300 XL Proximito<sup>®</sup> Sensor differs from its predecessor, its design allows it to fit in the same 4-hole mounting pattern when used with the 4-hole mounting base, and to fit within the same mounting space specifications (when minimum permissible cable bend radius is observed). Consult Specifications and Ordering Information (p/n 141194-01) or Bently Nevada Sales and Service Professional for more information.
4. Us of XL components with 3300 5mm Probes will limit system performance to the specifications for the non-XL 3300 system.
5. The factory supplies Proximito<sup>®</sup> Sensors calibrated by default to AISI 4140 steel. Calibration to other target materials is available upon request.
6. When considering this transducer system for tachometer or overspeed measurements, consult [www.bently.com](http://www.bently.com) for the application note regarding the use of eddy current proximity probes for over speed protection.
7. Silicone tape is also provided with each 3300 XL extension cable and can be used instead of connector protectors. Silicone tape is not recommended in applications where the probe-to-extension cable connection will be exposed to turbine oil.

**Specifications**

Unless otherwise noted, the following specifications are for a proximity transducer system between +18° C and +27° C (+64° F to +80° F) with a -24 Vdc power supply, a 10 kΩ load, an AISI 4140 steel target, and a probe gapped at 1.27 mm (50 mils).

**Electrical**

- XL Proximito<sup>®</sup> Sensor Input:** Accepts one noncontacting 3300 5 mm Proximity Probe and XL Extension Cable.
- Power:** Requires -17.5 Vdc to -26 Vdc at 12 mA maximum consumption. Operation at a more positive voltage than -23.5 Vdc can result in reduced linear range.
- Supply Sensitivity:** Less than 2 mV change in output voltage per volt change in input voltage.
- Output resistance:** 50 Ω

<i>Probe dc resistance (R<sub>PROBE</sub>)</i>	
Probe Length (m)	Resistance from the Center Conductor to the Outer Conductor (Ω)
0.5	7.45 ± 0.50
1.0	7.59 ± 0.50
1.5	7.73 ± 0.50
2.0	7.88 ± 0.50
5.0	8.73 ± 0.70
9.0	9.87 ± 0.90

<i>Extension cable dc resistance</i>		
Length of Extension Cable	Resistance from Center Conductor to Center Conductor (R <sub>CORE</sub> ) (Ω)	Resistance from Outer Conductor to Outer Conductor (R <sub>JACKET</sub> ) (Ω)
3.0	0.66 ± 0.10	0.20 ± 0.04
3.5	0.77 ± 0.12	0.23 ± 0.05
4.0	0.88 ± 0.13	0.26 ± 0.05
4.5	0.99 ± 0.15	0.30 ± 0.06
7.0	1.54 ± 0.23	0.46 ± 0.09
7.5	1.65 ± 0.25	0.49 ± 0.10
8.0	1.76 ± 0.26	0.53 ± 0.11
8.5	1.87 ± 0.28	0.56 ± 0.11

**Note:** Outer conductor refers to the shielded conductor that is attached to the connector, not the armor braid.

**Extension cable capacitance:** 69.9 pF/m (21.3 pF/ft) typical.

**Field Wiring:** Recommend using three-conductor shielded triad cable 0.2mm to 1.5mm (16 AWG to 24 AWG). 305 metres (1,000 feet) maximum length between 3300 XL Proximity Transducer and monitor. Consult Performance Specification 155687 for signal rolloff at high frequencies

when using longer field wiring lengths or external safety barriers located some distance from the monitoring system.

When gapped at the center of the linear range, the interaction between two separate transducer systems (cross-talk) will be less than 50 mV on shaft diameters of at least 50 mm (2 in) or greater. Maintain a minimum separation of transducer tips, generally at least 40 mm (1.6 in) for axial position measurements or 38 mm (1.5 in) for radial vibration measurements to limit cross-talk to 50 mV or less. Radial vibration or position measurements on shaft diameters smaller than 76.2 mm (3 in) will generally result in a change in scale factor. Consult Performance Specification 155687 for additional information.

**Linear Range:** 2 mm (80 mils). Linear range begins at approximately 0.25 mm (10 mils) from target and is from 0.25 to 2.3 mm (10 to 90 mils).

**Recommended Gap Setting:** 1.27 mm (50 mils).

**Incremental Scale Factor:** 7.87 V/mm (200 mV/mil)  $\pm 6.5\%$  typical, including interchangeability error when measured in increments of 0.25 mm (10 mils) over the linear range.

**Deviation from best fit straight line (DSL):** Less than  $\pm 0.038$  mm ( $\pm 1.5$  mil) typical deviation from best fit straight line.

**Probe Temperature Stability (typical):** Over probe temperature range of  $-35^{\circ}$  C to  $+177^{\circ}$  C ( $-31^{\circ}$  F to  $+350^{\circ}$  F), the incremental scale factor remains within  $\pm 10\%$  of 7.87 V/mm (200 mV/mil) and the deviation from the best fit straight line remains within  $\pm 0.076$  mm ( $\pm 3$  mils).

**Frequency Response:** 0 to 10 kHz: +0, -3 dB, with up to 305 metres (1000 feet) of field wiring.

**Minimum Target Size:** 15.2 mm (0.6 in) diameter (flat target).

**Shaft Diameter**

**Minimum:** 50.8 mm (2 in)

**Recommended minimum:** 76.2 mm (3 in)

<b>Effects of 60 Hz Magnetic Fields Up to 300 Gauss (5 metre system):</b>			
<b>Output voltage in mil pp/gauss:</b>			
<b>Gap</b>	<b>XL Proximito<sup>®</sup> Sensor</b>	<b>Probe</b>	<b>XL Ext. Cable</b>
10 mil	0.0119	0.0004	0.0004
50 mil	0.0131	0.0014	0.0014
90 mil	0.0133	0.0045	0.0045

**Electrical Certification:** Complies with the European CE mark.

**Hazardous Area Approvals**

Multiple approvals for hazardous areas certified by Canadian Standards Association (CSA/NRTL/C) in North America and by Baseefa (2001) in Europe.

**North America:**

Ex ia IIC T4/T5 for Class I Zone 0 or Class 1 Division 1; Groups A, B, C, and D, when installed with intrinsically safe zener barriers per drawing 141092, or when installed with galvanic isolators.

Ex nA IIC T4/T5 for Class I Zone 2 or Class 1 Division 2, Groups A, B, C, and D when installed without barriers per drawing 140979

T5 @ Ta =  $-35^{\circ}$  C to  $85^{\circ}$  C.  
T4 @ Ta =  $-51^{\circ}$  C to  $+100^{\circ}$  C

**Europe:**

 II 1 G EEx ia IIC T4/T5 EC certificate number BAS99ATEX1101, when installed per per drawing 141092.

 II 3 G EEx nA II T4/T5. EC certificate number BAS99ATEX3100U, when installed per drawing 140979.

T5 @ Ta = -35° C to 85° C.  
T4 @ Ta = -51° C to +100° C

IEC Ex:

**3300 XL Proximito<sup>®</sup> Sensor,  
ia**

IECEX BAS04.0055X

Ex ia IIC T4 / T5 (-51° C = Ta = +100° C / -35° C = Ta = +85° C)

Terminal Block Connections

Ui = -28V      Ci = 0

Ii = 140mA      Li = 10μH

Pi = 0.84W

Coaxial Connection

Ui = -28V      Ci = 5.7nF

Ii = 140mA      Li = 0.85mH

Pi = 0.84W

Load Parameters

The capacitance and either the inductance or the inductance to resistance (L/R) ratio of the load connected to the probe coaxial terminal must not exceed the following values:

Group	Capacitance μF	Inductance mH	L/R Ratio μH/Ω
IIC	0.077	0.99	35
IIB	0.644	7.41	142
IIA	2.144	15.6	295

**3300 XL Proximito<sup>®</sup> Sensor,  
nA**

IECEX BAS04.0057X

Ex nA II T4 / T5 (-51° C = Ta = +100° C / -35° C = Ta = +85° C)

The terminals must be provided with a level of protection of at least IP54.

Ui = -28V

**3300 5mm Eddy Current  
Probe, ia**

IECEX BAS04.0056

Ex ia IIC Temperature Classification per below.

T1: -51° C to +232° C  
T2: -51° C to +177° C  
T3: -51° C to +120° C  
T4: -51° C to +80° C  
T5: -51° C to +40° C

Ui = -28V      Ci = 1.5nF

Ii = 140mA      Li = 200μH

Pi = 0.84W

**3300 5mm Eddy Current  
Probe, nA**

IECEX BAS04.0058X

Ex nA II Temperature Classification per the temperature classifications above.

Must be supplied from a voltage limited source.

EEx nA for Zone 2, Group IIC, EC certificate number BAS99ATEX3100U.

**Mechanical**

- Probe Tip Material:* Polyphenylene sulfide (PPS).
- Probe Case Material:* AISI 303 or 304 stainless steel (SST).
- Probe Cable:* 75 Ohm triaxial, fluoroethylene propylene (FEP) insulated probe cable in the following lengths: 0.5, 1, 2, 5, or 9 metres.
- System Length:* 5 or 9 metres including extension cable.
- Extension Cable Material:* 75 Ω triaxial, fluoroethylene propylene (FEP) insulated.
- Probe and Extension Cable Armor:* Flexible AISI 302 or 304 SST with FEP outer jacket

**Note:** Exposing the probe to temperatures below -34°C (-30°F) may cause premature failure of the pressure seal.

*Tensile Strength*

*5 mm probe:* 222 N (50 lbf) probe case to probe lead. 222 N (50 lbf) probe lead to extension cable connectors.

*Connector material:* Gold-plated brass or gold-plated beryllium copper.

*Probe case torque:* Recommended torque:  
2.8 N·m (25 in·lb)  
Maximum torque:  
8.5 N·m (75 in·lb)

*Connector-to-connector torque*

*Recommended torque:* See table below.

*Maximum torque:* 0.565 N·m (5 in·ft)

Connector Type	Tightening Instructions
Two 3300 XL gold "click" type connectors	Finger tight
One non-XL stainless steel connector and one 3300 XL connector	Finger tight plus 1/8 turn using pliers

*Minimum Cable Bend Radius:* 25.4 mm (1.0 in).

*Total System Weight:* 0.71 kg (1.6 lbm), typical.

*3300 5mm Probe:* 323 g (11.39 oz).

*XL Extension Cable:* 34 g/m (0.4 oz/ft)  
103 g/m (1.5 oz/ft) (armored)

*XL Proximity® Sensor:* 246 g (8.7 oz)

*Extension Cable Temperature Range:* -51° C to +177° C (-60° F to +351° F) for standard extension cable (Ref. 141194-01).

**Probe Pressure:**

3300 5 mm probes are designed to seal differential pressure between the probe tip and case. The probe sealing material consists of a fluorocarbon O-ring. Probes are not pressure tested prior to shipment. Contact our custom design department if you require a test of the pressure seal for your application.

---

**Note:** It is the responsibility of the customer or user to ensure that all liquids and gases are contained and safely controlled should leakage occur from a proximity probe. In addition, solutions with high or low pH values may erode the tip assembly of the probe causing media leakage into surrounding areas. Bently Nevada®, LLC will not be held responsible for any damages resulting from leaking 3300 5 mm proximity probes. In addition, 3300 5 mm proximity probes will not be replaced under the service plan due to probe leakage.

---



---

**Patents:** 5,016,343; 5,126,664; 5,351,388; and 5,685,884. Components or procedures described in these patents apply to this product

---

**Ordering Information**

**Environmental Limits**

*Probe Temperature Range:* -35° C to +177° C (-31° F to +351° F)

**3300 5 mm Proximity Probes**

**330171 3300 5 mm Probe, 1/4-28 UNF thread, without armor**

**330172 3300 5 mm Probe, 1/4-28 UNF thread, with armor**

**Part Number-AXX-BXX-CXX-DXX-EXX**

**Option Descriptions**

*A: Unthreaded Length Option*      **Note:** Unthreaded length must be at least 0.8 in less than the case length.  
Order in increments of 0.1in  
**Length configurations:**  
Maximum unthreaded length: 8.8 in = **8 8**.  
Minimum unthreaded length: 0.0 in = **0 0**.  
**Example: 0 4** = 0.4 in

*B: Overall Case Length Option*      Order in increments of 0.1 in  
**Threaded length configurations:**  
Maximum case length: 9.6 in = **9 6**.  
Minimum case length: 0.8 in = **0 8**.  
**Example: 2 4** = 2.4 in

*C: Total Length Option*      **0 5** 0.5 metre (1.6 feet)  
**1 0** 1.0 metre (3.3 feet)  
**2 0** 2.0 metres (6.6 feet)  
**5 0** 5.0 metres (16.4 feet)<sup>1</sup>  
**9 0** 9.0 metres (29.5 feet)

*D: Connector Option*      **0 1** Miniature coaxial ClickLoc™ connector with connector protector, standard cable  
**0 2** Miniature coaxial ClickLoc™ connector, standard cable

*E: Agency Approval Option*      **0 0** Not required  
**0 5** Multiple Approvals

**3300 5 mm Proximity Probes, Metric**

**330173 3300 5 mm Probe, M8 x 1 thread, without armor**

**330174 3300 5 mm Probe, M8 x 1 thread, with armor**

**Part Number-AXX-BXX-CXX-DXX-EXX**

**Option Descriptions**

*A: Unthreaded Length Option*

**Note:** Unthreaded length must be at least 20 mm less than the case length.

Order in increments of 10 mm.

**Length configuration:**

Maximum unthreaded length: 230 mm = **2 3**.

Minimum unthreaded length: 0.0 mm = **0 0**.

**Example: 0 6** = 60 mm.

*B: Overall Case Length Option*

Order in increments of 10 mm.

**Metric thread configurations:**

Maximum length: 250 mm = **2 5**.

Minimum length: 20 mm = **0 2**.

**Examples: 0 6** = 60 mm.

*C: Total Length Option*

**0 5** 0.5 metre (1.6 feet)

**1 0** 1.0 metre (3.3 feet)

**2 0** 2.0 metres (6.6 feet)

**5 0** 5.0 metres (16.4 feet)<sup>1</sup>

**9 0** 9.0 metres (29.5 feet)

*D: Connector Option*

**0 1** Miniature coaxial ClickLoc™ connector with connector protector, standard cable

**0 2** Miniature coaxial ClickLoc™ connector, standard cable

*E: Agency Approval Option*

**0 0** Not required

**0 5** Multiple Approvals

**3300 XL Proximitor<sup>®</sup> Sensor**

**See 141194-01. Make sure that the extension cable length and the probe length, when added together, equal the Proximitor<sup>®</sup> Sensor total length.**

**3300 XL Extension Cable**

See 141194-01 Make sure that the extension cable length and the probe length, when added together, equal the Proximitor<sup>®</sup> Sensor total length.

---

**Accessories**

**141078-01**

Manual

**02120015** Bulk field wire. 1.0 mm<sup>2</sup> (18 AWG), 3-conductor, twisted, shielded cable for connections between Proximator® Sensor and monitor.

**Aluminum probe mounting bracket  
137492 -AXX  
Option Descriptions**

A: Thread size

- 0 2** 1/4-28
- 0 3** M8 x 1

The aluminum probe threaded mounting bracket is the standard mounting bracket for most 3300 5 mm probe installations. The -02 option is supplied with two 10-24 UNC-2A mounting screws. The -03 option is supplied with two M5 x 0.8-6g mounting screws. The mounting screws have pre-drilled holes for safety wire.

**Phenolic probe mounting bracket  
27474 -AXX  
Option Descriptions**

A: Thread size

- 0 2** 1/4-28
- 0 3** M8 x 1

The phenolic mounting bracket is recommended if additional electric isolation from the mounting location is required (as in some generator and electrical motor bearing locations). The -02 option is supplied with two 10-24 UNC-2A mounting screws. The -03 option is supplied with two M5 x 0.8-6g mounting screws. The mounting screws have pre-drilled holes for safety wire.

**03200006**  
Silicone self-fusing tape

9.1 metre (10 yard) roll of silicone tape to protect connectors. It is easy to install and provides excellent electrical isolation and

**40113-03**  
Connector Protector Kit

Connector Protector Kit for 3300 5 mm probes, including connector protectors and installation tools.

**136536-01**  
Connector Protector Adapter

Makes connector protector kits purchased prior to 1998 compatible with ClickLoc™ extension cable connectors.

**40180-03**  
Connector Protectors

Package containing 10 pairs of 75 ohm Coaxial Connector Protectors.

**03839410**  
75 ohm Triaxial/95 ohm Coaxial Male Connector Protector

Placed onto the extension cable; attaches to the female connector protector on the 5 mm probe to provide environmental protection of connectors.

**03800001**  
75 ohm Coaxial Female Connector Protector

Placed onto 3300 5 mm probe leads; attaches to the male connector protector on the extension cable to provide environmental protection of connectors.

**163356**  
Connector Crimp Tool Kit

Includes one set of multi-connector inserts and connector installation instructions. Compatible only with 330153 connector kits or with probes shipped in 2003 or later with ClickLoc™ connectors uninstalled. Supplied with carrying case.

**75 W ClickLoc™  
Connector Kit  
330153-AA  
Option Descriptions**

- 0 2** One ClickLoc™ male connector for 3300 XL 5 mm and 8 mm extension cable.
- 0 3** One ClickLoc™ female connector for 3300 XL 5 mm and 8 mm extension cable.
- 0 4** One ClickLoc™ male connector for 3300 5 mm probe.

75 Ω ClickLoc™ Connector Kit for

3300 series probes and extension cables. Each kit contains one color-coded sleeve per connector.

© 2005 Bently Nevada®, LLC

ClickLoc™, Keyphasor®, NSv™, Proximator®, TipLoc™, and the Orbit logo are trademarks of Bently Nevada, LLC.



Graphs

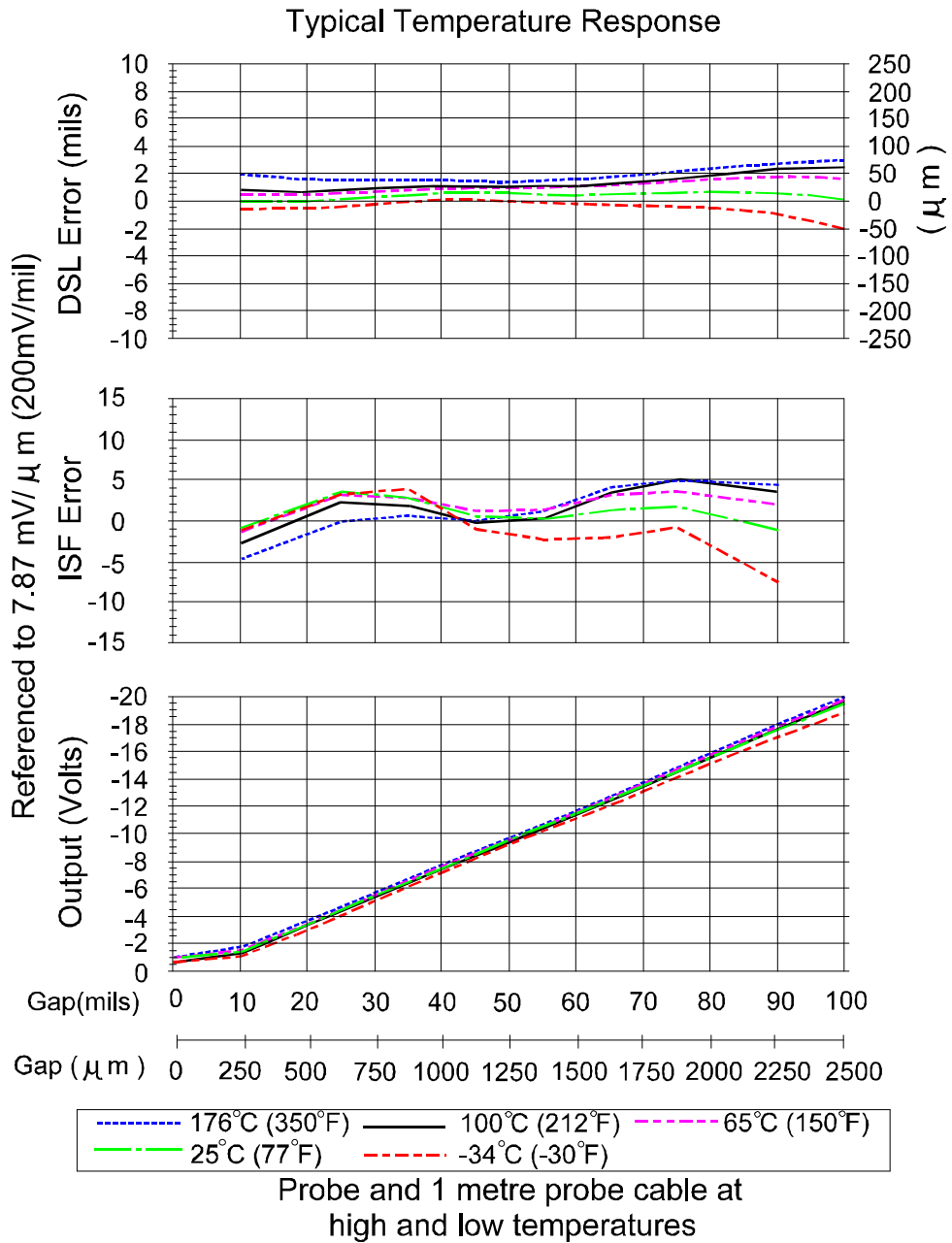

Figure 1 - Typical 3300 5 mm probe and 1 metre of cable at high and low temperatures (XL Proximitor® Sensor and XL extension cable are at 25°C)

## Typical Temperature Response

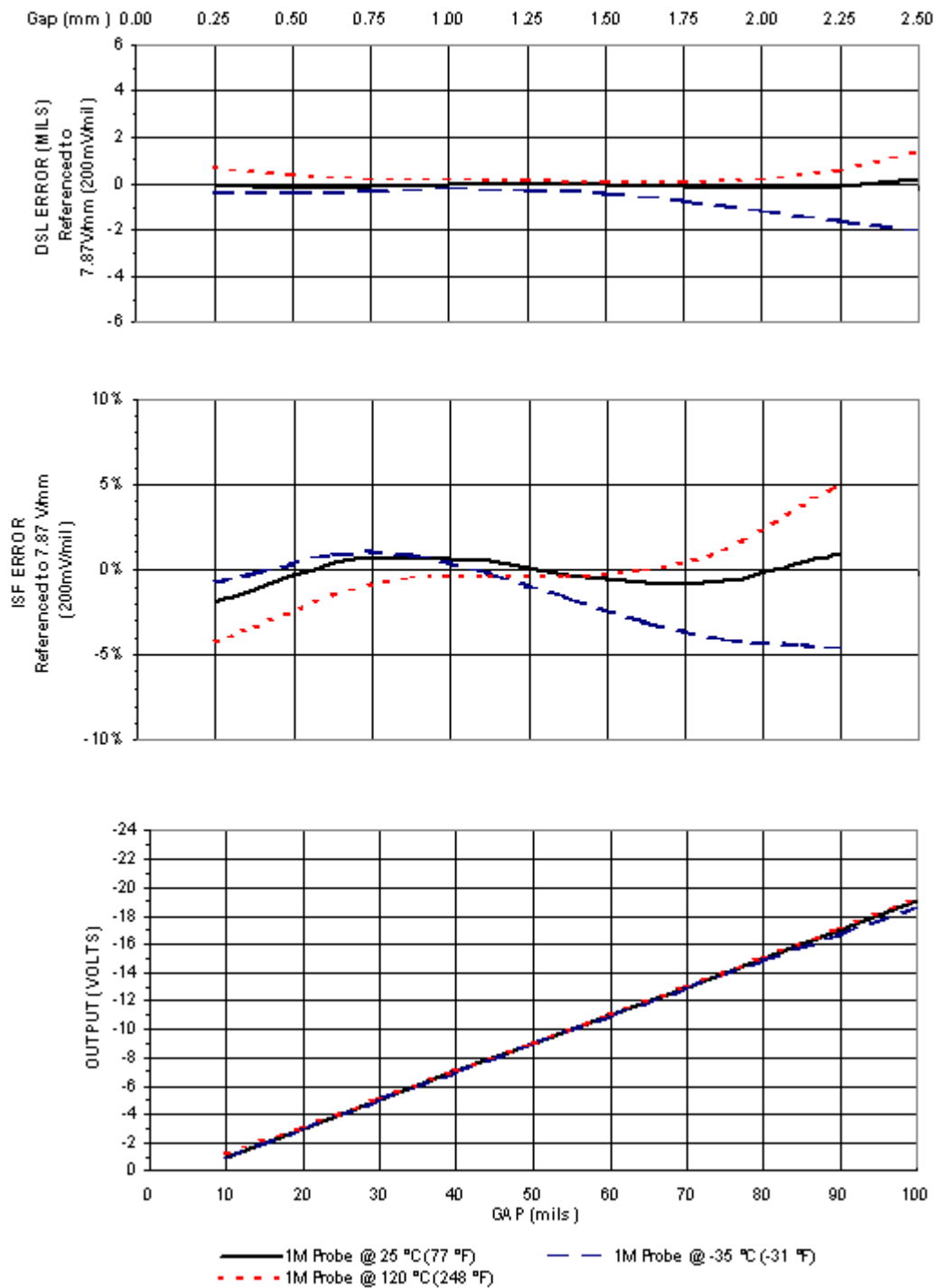
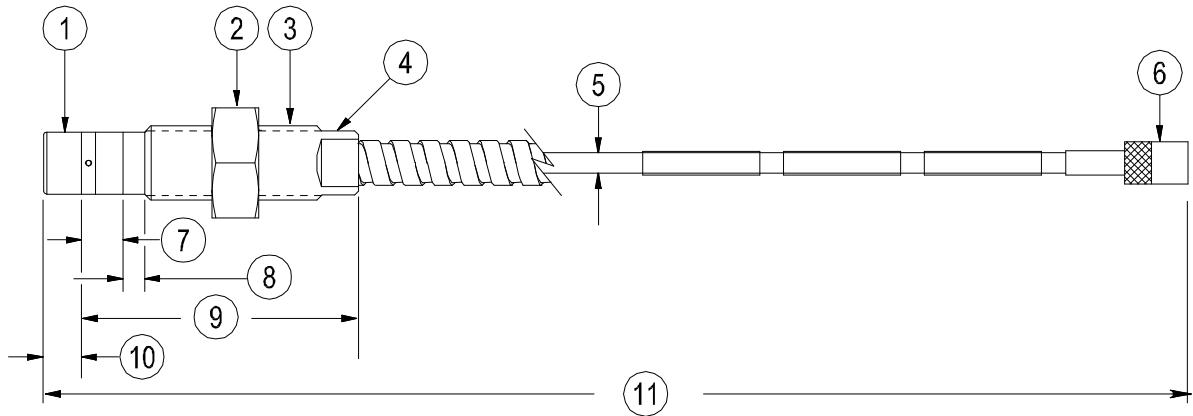

Figure 2 - 3300 5 metre XL Proximity® Sensor at high temperatures (3300 5mm probe and XL extension cable at 25° C)

## Dimensional diagrams



1	Probe tip, 5.2 (0.21) diameter	7	3.2 (0.13)
2	11.1 (7/16) for 1/4-28 threads <sup>3</sup> 13.0 (0.51) for M8 threads <sup>3</sup>	8	Unthreaded length "A"
3	Case thread	9	Case length "B"
4	5.6 (7/32) wrench flats for 1/4-28 threads 7.0 (0.28) for M8 threads 4 each	10	6.0 (0.235) maximum
5	75 ohm cable, 2.8 (0.11) maximum outside diameter, 7.6 (0.3) outside diameter of armor, 9.0 (0.35) maximum diameter of armor ferrule	11	Total length <sup>8</sup> "C", +30%, -0%
6	Miniature male coaxial connector, 7.23 (0.285) outside diameter maximum "D"		

**Figure 3 - 3300 5 mm Proximity Probes, Standard Mount<sup>3</sup>**

330171, 1/4-28 UNF-2A, without armor<sup>7</sup>

330172, 1/4-28 UNF-2A, with armor<sup>6</sup>

330173, M8X1 thread, without armor<sup>7</sup>

330174, M8X1 thread, with armor<sup>6</sup>

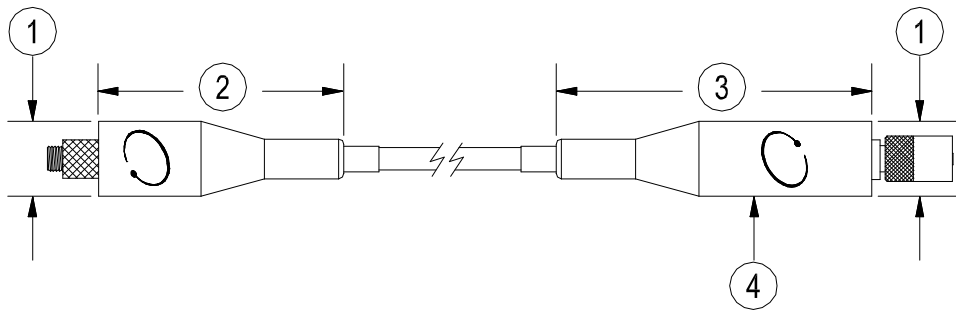

1	12 (0.49) diameter maximum	3	51.1 (2.01) maximum
2	36.3 (1.43) maximum	4	Connector protector (fluorosilicone material)

Figure 4 - Installed Connector Protectors

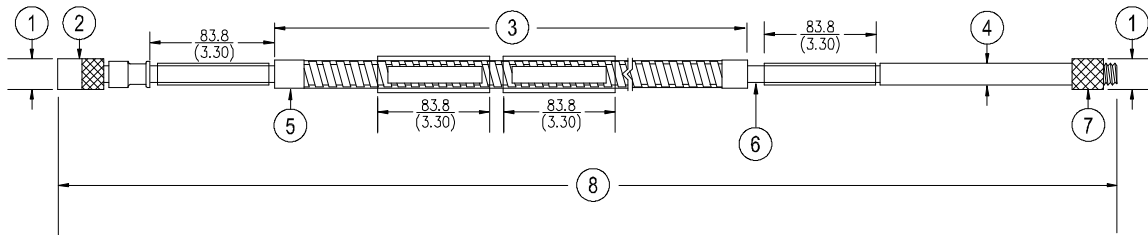

1	7.2 (0.285) maximum diameter	5	Stainless steel ferrules, 8.4 (0.33) diameter
2	Miniature male coaxial connector	6	FEP or PFA insulated triaxial cable
3	FEP or PFA coated armor <sup>6</sup> . Armor length: 300 (11.8) less than cable length	7	Miniature female coaxial connector
4	75 ohm cable 3.7 (0.15) maximum outside diameter 3.9 (0.16) maximum diameter for FluidLoc® cable 7.6 (0.30) maximum outside diameter of armor 9.0 (0.35) maximum diameter of armor ferrule	8	Cable length +20%, -0%

Figure 5 - 3300 XL Extension Cable

330130, 3300 XL Extension Cable (FEP armor and insulation)

**Notes:**

1. All dimensions are in millimetres (inches) unless otherwise noted.
2. Deleted
3. Standard mount 5 mm probes supplied with 13 mm or 7/16-in lock nut.
4. Deleted
5. Letters inside quotation marks refer to probe ordering options.
6. Stainless steel armor is supplied with FEP outer jacket for standard probes, PFA outer jacket for ETR probes.
7. FEP jacket is standard non-armored portion of the cable for standard probes, PFA jacket on non-armored portion for ETR probes.
8. Probes ordered with 5 or 9 metre integral cables have a length tolerance of +20%, -0%.
9. Five metre probes are designed for use with the five metre Proximito<sup>®</sup> Sensor only.