

Datasheet Integrated Sensor SMD

Type HCM Cx2 Fx



Features and Benefits

- Small size, low cost, integrated ASIC with analog outputs
- Surface mountable ceramic leadless chip carrier CLCC, square, width 3.8mm
- Operating range 2.7V to 5.5V , -40°C to 120°C
- Sensor gain adjustable to 4300 or 2150 (preset 4300 by internal pull-up res.)
- Integrated linear temperature reference with a sensitivity of typical 16mV/°C
- Large variety of available filter types for different application

Ordering Information

HCM -> Heimann thermopile sensor and ASIC in a SMD ceramic carrier
 Cx2 -> „C” ceramic carrier 3.8mm ; „x” sensor chip (list) ; „2” ASIC type
 Fx -> application-specific filter type (list)

Sensor Chip Selection			
Parameter	Sensor chip "1"	Sensor chip "1C"	Sensor chip "2"
Absorbing area	0.61 x 0.61mm ²	0.76 x 0.76mm ²	1.2 x 1.2mm ²
Sensitivity	50 V/W	46 V/W	38 V/W
Voltage response	19 Vmm ² /W	27 Vmm ² /W	55 Vmm ² /W
Resistance	85 kOhm	85 kOhm	85 kOhms
Time constant	5 ms	6 ms	8ms

Filter Selection		
Filter Type	Application	Specification
F4.26-180	CO2 gas detection	NBP CWL 4.26µm HPB 180nm
F4.43-60	CO2 gas detection	NBP CWL 4.43µm HPB 60nm
F4.64-180	CO gas detection	NBP CWL 4.64µm HPB 180nm
F3.30-160	HC gas detection	NBP CWL 3.30µm HPB 160nm
F3.37-190	HC gas detection	NBP CWL 3.375µm HPB 190nm
F3.91-90	gas reference	NBP CWL 3.91µm HPB 90nm
F5.5	temperature detection	LWP Cut On 5.5µm
F8-14	temperature detection	BP HPP 8µm to 14µm

Please contact Heimann customer service for special filter requirements.

Datasheet Integrated Sensor SMD

Type HCM Cx2 Fx



Operating Conditions

Parameter	Typical Value	Unit	Condition
Supply voltage VDD	(2.7).. 3 .. 5..(5.5)	V	+Vs
Supply voltage VSS	0	V	-Vs , Ground
Supply current	1	mA	Without load
Open loop gain	90	dB	
Low pass frequency	240	Hz	ASIC
PSRR	>40	dB	
Output voltage range	0.15 .. (VDD-0.15)	V	
Start up time after POR	Max. 0.5	sec	Electrical start up
Noise voltage input related	45	nV/ \sqrt{Hz}	Output TPO; Sensor + ASIC
Zero input sensor signal	1.3	V	Output TPO
Sensor gain adjustment	4300 or 2150	V/V	Output TPO ; adjustable
Temp. ref. voltage at 25°C	1.5	V	Output TRO
Sensitivity temp. reference	16	mV/°C	Linear ; Output TRO
Field of view	120	degree	
Operating temperature	-40.. 120	°C	

Pin Assignment

Pin No.	Sym bol	Description
1	GAIN	Gain factor 4300 (Internal pull up or VDD on GAIN) Gain factor 2150 (VSS/GND on GAIN)
3	VDD	Positive supply voltage
4 / 8	VSS/ GND	Negative supply voltage / Ground (0V)
6	TPO	Amplified thermopile sensor output voltage
7	TRO	Analog temperature reference output voltage

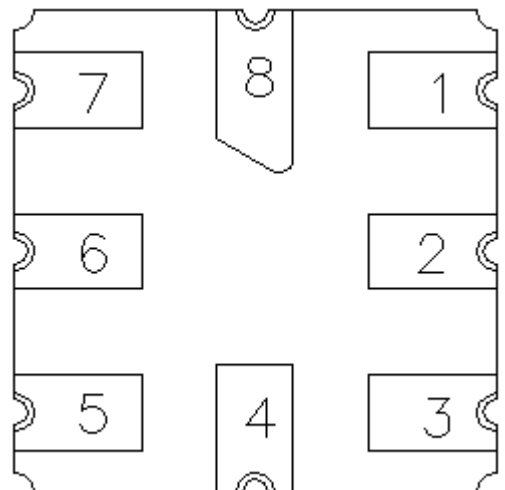

Datasheet Integrated Sensor SMD

Type HCM Cx2 Fx



PCB Footprint

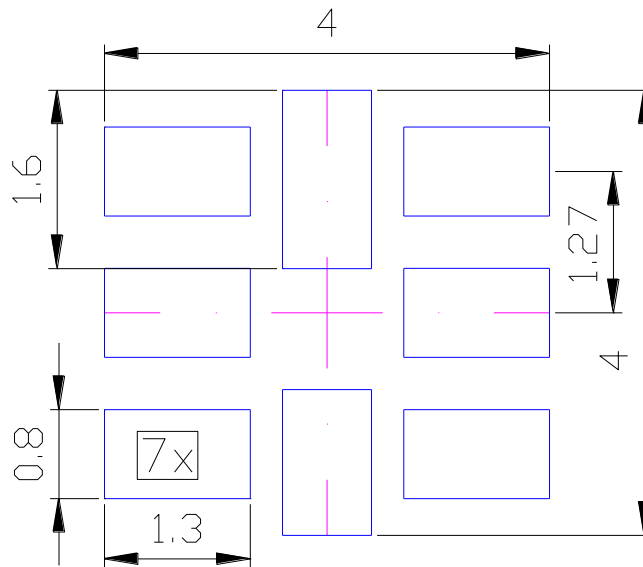

Reflow Furnace Profile

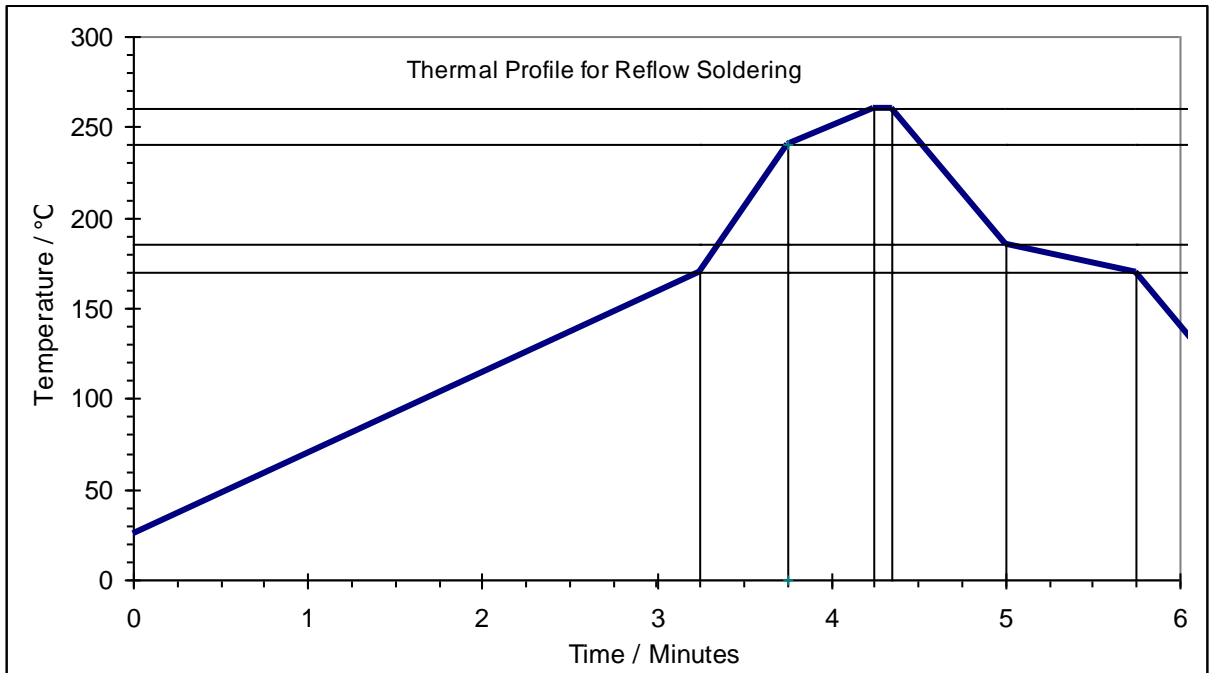

Suitable for lead free soldering.

The shown thermal profile should not be exceeded or component damage may result.

Datasheet Integrated Sensor SMD

Type HCM Cx2 Fx



Dimensions

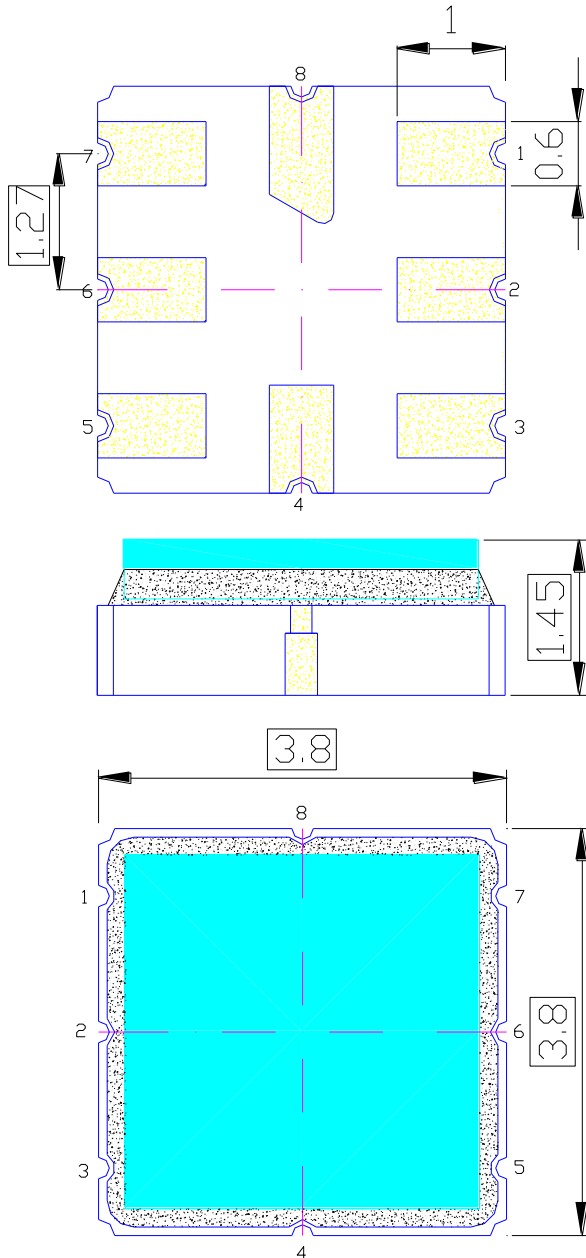

HCM C12 ..

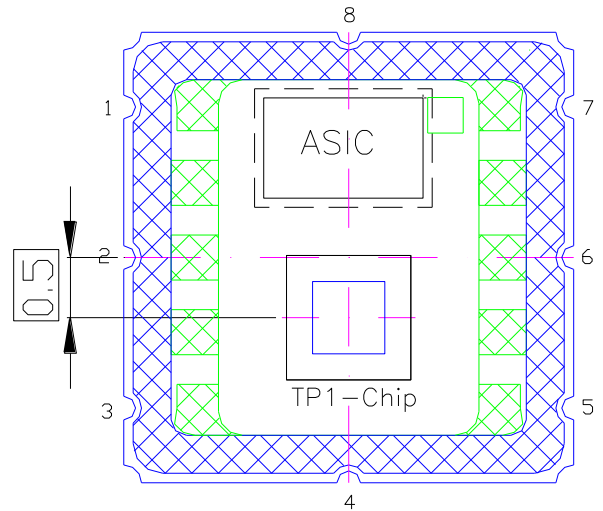

HCM C1C2 ..

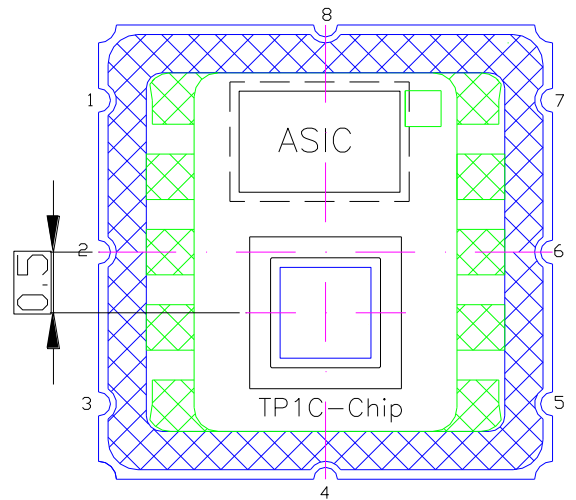

Liability

Changes or modifications at the product which haven't influence to the performance and/or quality of the device haven't to be announced to the customers in advance. Customers are requested to consult with Heimann Sensor representatives before the use of Heimann Sensor products in special applications where failure or abnormal operation may directly affect human lives or cause physical injury or property damage. The company or their representatives will not be responsible for damage arising from such use without prior approval.

Datasheet Integrated Sensor SMD

Type HCM Cx2 Fx



Application Circuitry

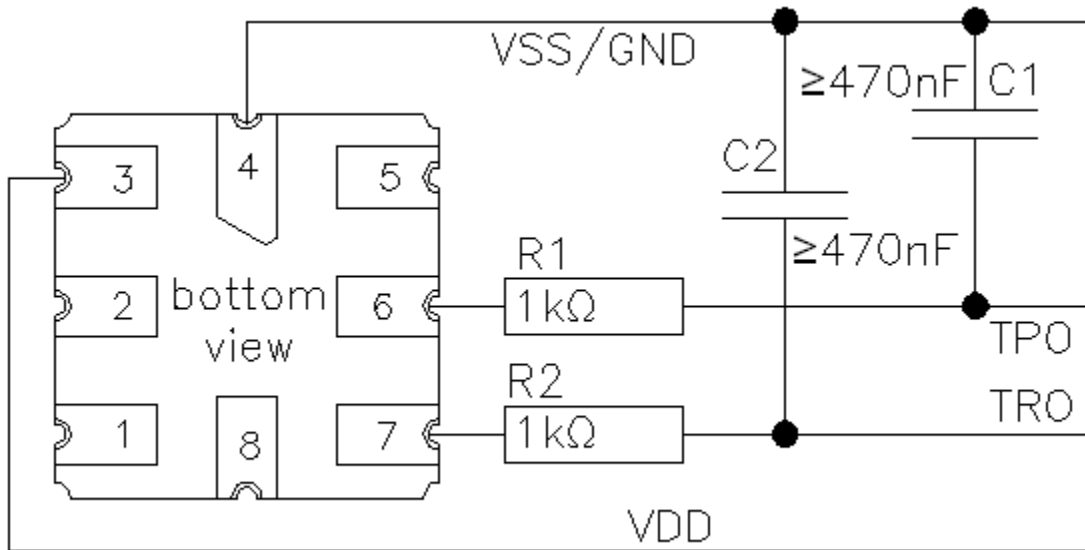

Due to use of chopper-stabilized amplifiers residual ripples of chopping frequency can interfere on the outputs in the range of 20kHz.

Software filtering or for resistive loads of $\geq 1M\Omega$ simple RC low pass filtering can be used to suppress the ripple. Sample circuitry is shown on above picture.

Application Hints

A gas concentration can be measured by monitoring the absorption of an infrared light beam. The base equation for gas concentration measurement in the infrared way is Beer's law :

$$I = I(0) * \exp(-k * c * L)$$

- I -> radiant flux at the point of measurement
- I(0) -> base radiant flux of the test system without gas absorption
- k -> constant (gas and filter specific)
- L -> measuring distance
- c -> gas concentration

The radiant flux is proportional to the output voltage of the sensor module :
 $U/U(0) \sim I/I(0)$.

A special infrared light source is used to generate the radiant heat. The infrared source needs to be pulsed to eliminate parasitic temperature influences. Don't hesitate to contact HEIMANN Sensor for support to use our long-time experience in infrared sensors and sensor modules.