



SGX Infrared Gas Sensor Evaluation Kit IR-EK2

User Guide



IMPORTANT INFORMATION

Before using this product, please read and understand all the instructions and warnings. SGX Sensortech does not accept responsibility for damage or injury resulting from failure to follow the instructions provided.

WARNINGS:

- The Evaluation Kit is despatched from SGX Sensortech in a safe condition. Any unauthorised modifications may compromise safety and invalidate the warranty.
- The supplied power supply adapter is double insulated, indicated by the double square symbol. If the Evaluation kit is used with a power supply which is not double insulated, connect a Protective Earthing Connection to the Protective Earth terminal on the PCB indicated by the Protective Earth symbol in case of power supply faults.
- The Evaluation Kit is not certified as intrinsically safe and therefore must not be operated in potentially flammable or explosive atmospheres.
- **Neglecting the above may result in injury or death.**



CAUTIONS:

- The Evaluation Kit is intended for engineering development, demonstration or evaluation purposes only. It is not considered to be suitable for general consumer use and should be handled by people with suitable electronics training.
- The Evaluation Kit contains electrostatic discharge sensitive devices. Always observe handling precautions.
- The Evaluation Kit and Gas Sensor Devices should always be used within their ratings as given in their data sheets.



COMPLIANCE:

- The Evaluation Kit is intended for engineering development, demonstration or evaluation purposes only and not for sale on the open market.
- This Evaluation Kit has been tested (but not certified) and deemed to comply with the limits for a Class B digital device, pursuant to part 15 of the FCC Rules and European Union directives on electromagnetic compatibility. These limits are designed to provide reasonable protection against harmful interference when the equipment is operated in a commercial environment. This equipment generates, uses, and can radiate radio frequency energy and if not installed and used in accordance with the instruction manual, may cause harmful interference to radio communications. The user is responsible for providing reasonable protection against interference with other electronic equipment.
- The Evaluation Kit is not intended for automotive use. It does not contain protection devices against vehicle supply transient voltages and must not be used for the control of a vehicle, a vehicular safety system or in a way that may disturb the driver, data bus or statutory devices fitted to a vehicle.

ENVIRONMENTAL:

- SGX Sensortech declares that the Evaluation Kit complies with EC directive 2002/95/EC (the RoHS Directive) restricting the use of certain hazardous materials in electrical and electronic equipment. See section 17 for China RoHS information.
- The Evaluation Kit is classified as Electronic and Electrical Equipment according to directive 2002/96/EC (the WEEE Directive) and should be segregated from domestic waste for disposal. Contact your local SGX sales office for disposal instructions.



Contents

1	Introduction	4
2	Quick Start Guide	5
3	Using the SGX Data Logging Software	7
4	Using HyperTerminal	9
5	User Interfaces, Controls and Indicators	11
5.1	Power Supply (SK4, TB1).....	11
5.2	USB Interface (SK5)	11
5.3	Gas Sensors Sockets (S1, S2).....	11
5.4	Signal Monitor (PL3).....	11
5.5	User Adjustments (VR0, VR1, VR2, VR3).....	11
5.6	JTAG Port (PL1)	11
5.7	Expansion Port (PL2).....	12
5.8	LEDS (D1, D2, D3, D4, D5).....	12
5.9	Reset Switch (SW2).....	12
6	Operating Modes	13
6.1	Introduction	13
6.2	Measurement Mode.....	13
6.3	Device Setup Mode	13
7	Lamp Drive	14
7.1	Frequency	14
7.2	Voltage.....	14
8	Channel Gains	15
9	Sensor Set-up.....	16
10	Calibration.....	17
11	Analog Outputs	17
12	Alarm Outputs and LEDs	18
13	Digital Inputs	18
14	Appendix: Evaluation Kit PCB Schematic Diagram	19
15	Appendix: Evaluation Kit PCB Parts List	20
16	Appendix: Serial Message Protocol.....	21
17	Appendix: China RoHS Declaration.....	24

1 Introduction

Thank you for purchasing the SGX Infrared Gas Sensors Evaluation Kit

SGX Infrared Gas Sensors are reliable and stable devices capable of detecting many different gases as specified on individual device data sheets. These devices can be used in many different applications and this Evaluation Kit from SGX will allow you to experiment and find the most suitable mode of operation for your particular use.

This Evaluation Kit allows you to:

- Test one 6- or 7-pin single gas sensor or one 8-pin twin gas sensor
- Adjust the lamp drive voltage between 3.0 V and 5.0 V
- Adjust the channel gains for the reference and active channels
- Calibrate a gas sensor and measure gas concentration levels
- Set four alarm levels (2 per channel) which drive on-board LEDs and open collector outputs.
- Drive two analogue outputs
- Connect additional circuits to an expansion port
- Log readings of peak-to-peak output signal, gas concentration and temperature using the supplied PC Data Logging Program.

Contents of Evaluation kit

- Evaluation PCB
- Mains Power Adapter
- USB Lead
- CD containing User Manual, e2v Data Logging Software and USB Drivers
- Gas Flow Hood

Accessories Available

- Additional gas flow hoods may be ordered using the part number: JAS767906AA

If you are not familiar with the principles of gas detection using infrared absorption, you are strongly recommended to read SGX Infrared Application Notes available at www.SGX.com

2 Quick Start Guide

1. Read the Manual!

- The supplied CD should auto-run on your PC when inserted into a CD drive.
- Select 'User Guide' from the CD menu.

Before using this product, please read and understand all the instructions and warnings. SGX Sensortech does not accept responsibility for damage or injury resulting from failure to follow the instructions provided!

2. Install the SGX Data Logging Software & USB Drivers on your PC

- Select 'Install Data Logging Software and USB Drivers' from the CD menu.
- Follow the on-screen instructions.

3. Set up the Evaluation PCB

- Plug an SGX infrared gas sensor into the Evaluation Kit
6- or 7-pin single gas devices plug into S1; 8-pin twin-gas devices plug into S2
- Adjust variable resistor VR3 fully anticlockwise (minimum bulb voltage)
- Adjust variable resistors VR0, VR1, VR2 fully anti-clockwise (minimum signal gains)
- Connect the supplied USB lead from SK5 to a USB socket on your PC

4. Connect the 9 V Power Supply Unit

- Connect the DC output of the Power Supply Unit to SK4.
- Slide the correct pinned mains adapter to the Power Supply Unit to suit the mains sockets in your country. Plug in the Power Supply Unit. Green LED D5 should be flashing. Other LEDs may also come on.
- The PC may take a minute to recognise and initialise the new hardware drivers.

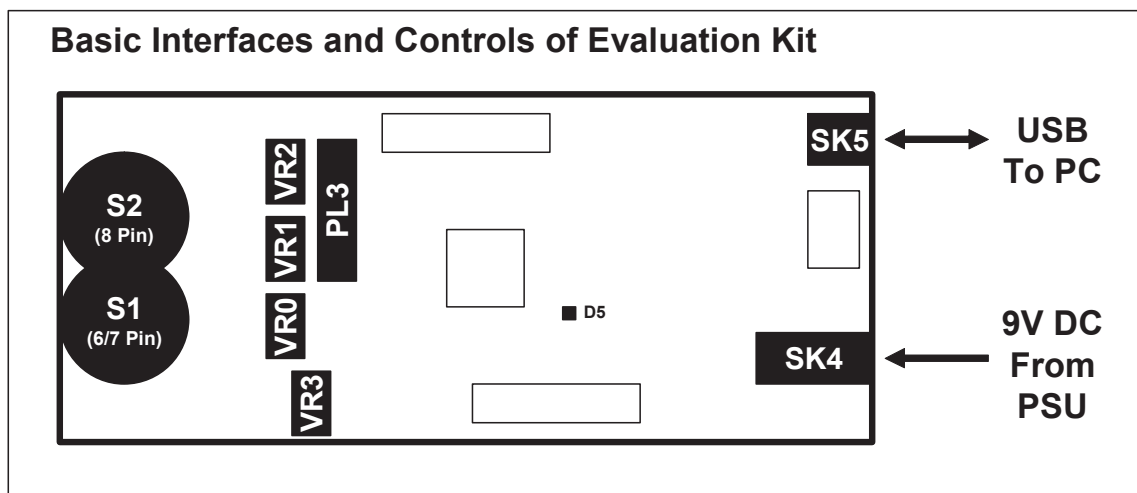

Quick Start Guide (Continued)

5. Run the SGX Data Logging Software

- a. Run the program from the start menu.
- b. The software will automatically detect which 'Com Port' is being used for the USB connection. (If this does not happen, a Com Port can be manually selected by unticking 'Automatically search for connected device' on the 'Hardware' menu.
- c. The software will switch the Evaluation PCB into 'Automatic Mode' so that readings are sent from the Evaluation Kit to the PC once every second.
- d. The outputs of the Evaluation Kit will now be displayed on the PC monitor.

6. Set the Bulb Voltage and Channel Gains

- a. Select the 'Readings' tab. The bulb voltage is displayed.
- b. Adjust **VR3** clockwise to the desired **Bulb Voltage** (between 3 V and 5 V)
- c. Adjust **VR0** to set the **Reference level** output. Set to approximately 2 V peak-to-peak if possible. The signal clips at 3 V.
- d. Adjust **VR1** to set the **Active level** output in the same way.
- e. Adjust **VR2** to set the **Second Active level** output in the same way, only if using a twin-gas sensor.
- f. If desired, the channel outputs can be observed on an oscilloscope via PL3

Congratulations! You are now evaluating SGX Infrared Gas Sensors.

7. Further Settings

- a. At this stage you may not have correct temperature or concentration readings.
- b. The software must be told which type of temperature sensor is being used.
- c. A calibration will need to be performed to obtain accurate concentration readings.
- d. To change any set-up parameters, the Evaluation Kit must be switched from 'Measurement Mode' to 'Device Setup Mode' using the PC Software.
- e. Refer to the relevant sections of the User Guide for detailed instructions on how to do the above.

3 Using the SGX Data Logging Software

Follow the instruction in the Quick Start guide to get the software operating. The screen should appear similar to that shown below:

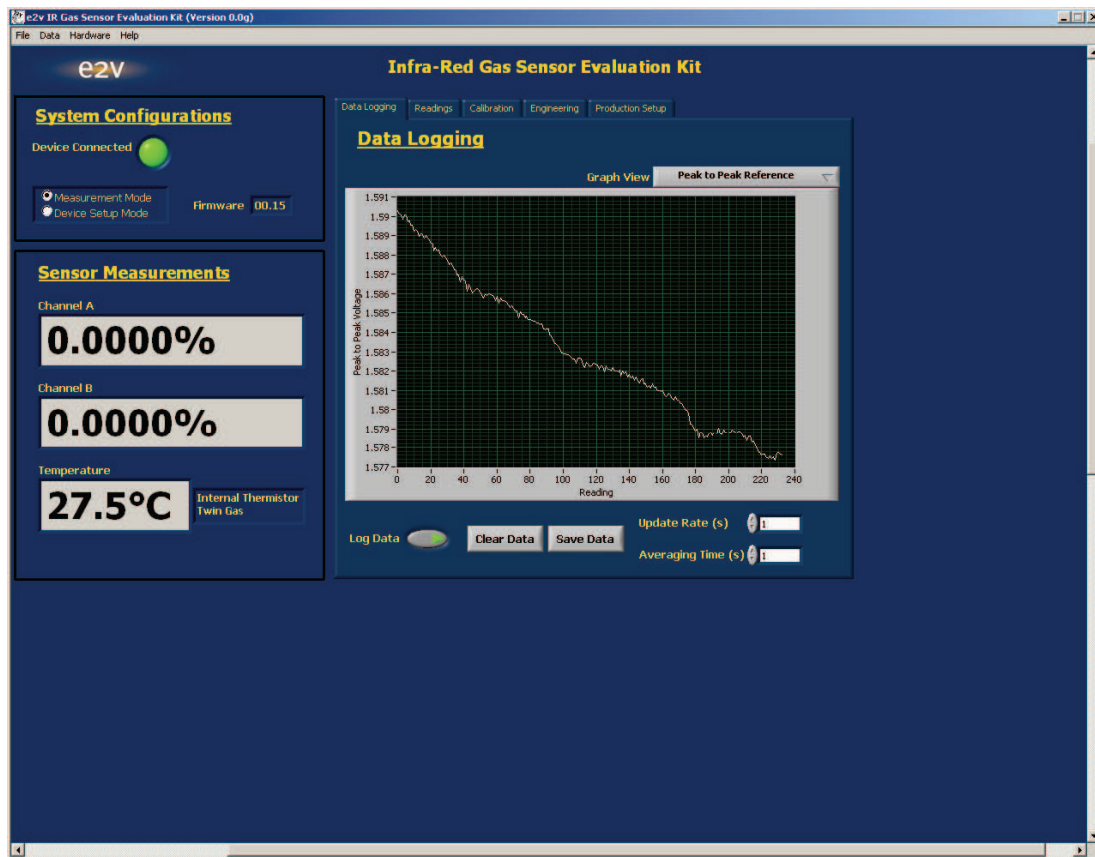

The USB interface to the Evaluation Kit appears as a virtual 'Com Port'. When the program is started the software will automatically detect which 'Com Port' is being used for the USB connection. (If this does not happen, a Com Port can be manually selected by unticking 'Automatically search for connected device' on the 'Hardware' menu. The Com Port can be manually selected, using trial and error to identify the correct one. If multiple Evaluation Kits are used at the same time, a separate instance of the program should be started for each one – it will be necessary to manually set each one to the correct Com Port.

The main screen gives a continuous display of gas concentration and temperature. The graph view can be changed to display various parameters in real time. The data can also be saved to a file in 'csv' format which can be read by most spreadsheet programs. Note that many spreadsheets will read a maximum of 65536 lines (18 hours of data at 1 second intervals). The measurement period can be increased from 1 second to allow longer tests to be imported. For example, a 10 second measurement period allows 7.5 days of data to be read into a spreadsheet. An averaging time can also be set to smooth out the data.

By default, the datalogging software autoscales the output readings (i.e. the graph axes expand to show all of the readings on x and y axes). However, it is possible to change these values in order to 'zoom in' on certain readings.

In the Data Logging tab, right-click on the axis to be adjusted and untick 'AutoScale'.

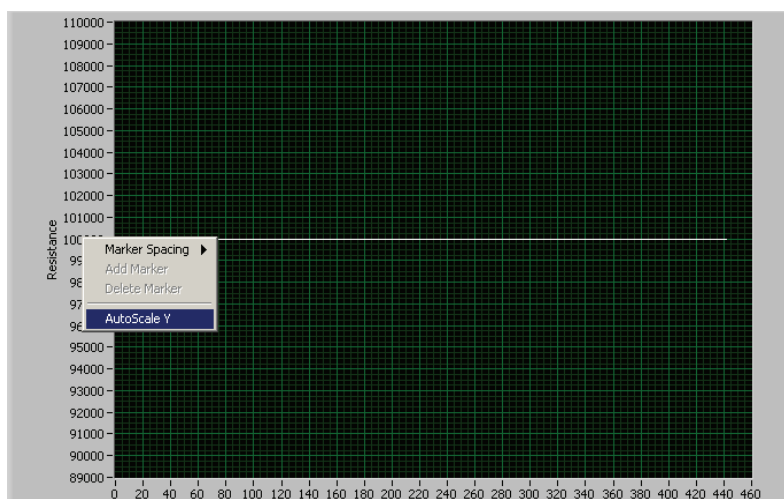

This stops the axis from automatically expanding.

The values in the axis can then be changed. To do this, double-click on the value you wish to edit and adjust using the keypad.

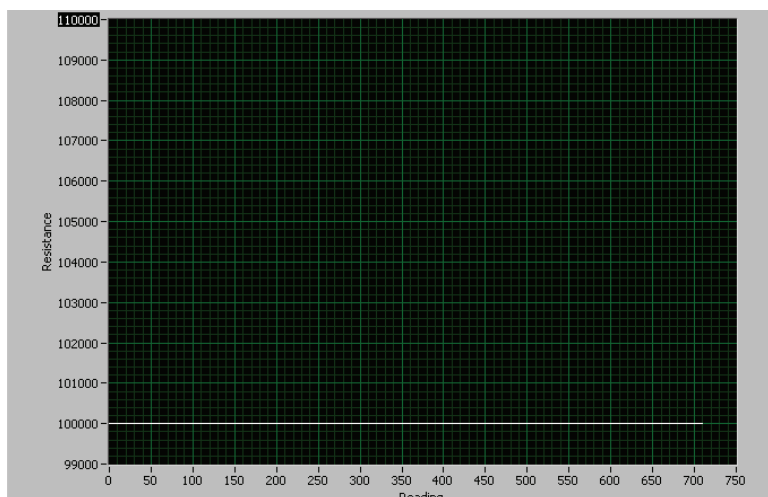

The 'Readings' tab provides measurement and control of the bulb and measurement of channel peak-to-peaks and ratios, described in section 7 and 8

The 'Alarms' tab allows setting of alarm thresholds, described in section 12.

The 'I/O' tab only appears in 'Device Setup Mode' and allows setting of analog outputs (see section 11) and monitoring of digital inputs (see section 13).

The 'Calibration' tab allows calibration of sensor zero and span levels. When in 'Device Setup Mode' it also enables a number of important sensor settings to be sent to the Evaluation Kit (see section 9) including:

- Selection of temperature sensor
- ADC sampling delay time
- Temperature compensation and calibration coefficients

The 'Hardware' menu contains an Update Firmware feature which allows software updates to be loaded into the microprocessor without having to return the PCB to SGX for reprogramming. This feature should be used carefully following the instructions in section 18.

4 Using HyperTerminal

The SGX Data Logging software provides full control and monitoring of all the operation modes of the Evaluation Kit. It is possible to communicate with the Evaluation Kit using the low level protocol. This can be done manually using a terminal emulation program such as HyperTerminal, or by writing your own PC software using a language such as Visual Basic or Labview. The low level message protocol is given in the appendices to this manual.

To communicate with the Evaluation Kit using HyperTerminal use the following procedure:
(Note: the USB Drivers must be installed.)

- Run HyperTerminal from the Windows Start button
- Enter a name and choose an icon:

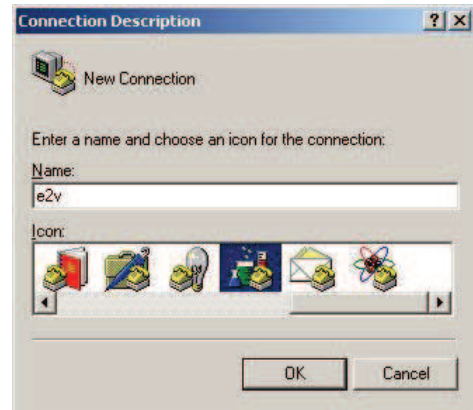

- Select the correct 'COM Port' being used by the USB Driver:



- Select 9600 Bits per second (Baud), 8 data bits, no parity, 1 stop bit, no flow control:

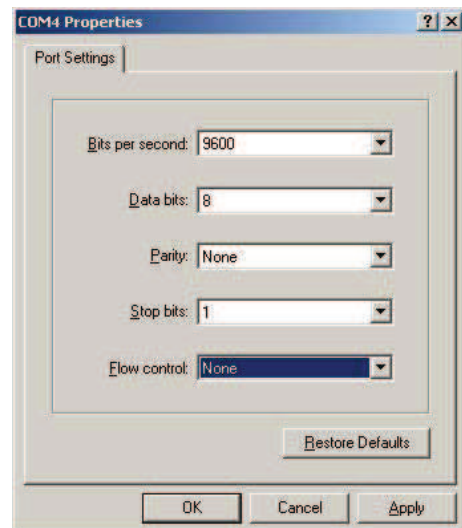

- Select File/Properties. Click the Settings tab, then the ASCII Setup button. Ensure 'Echo typed characters locally' is checked:

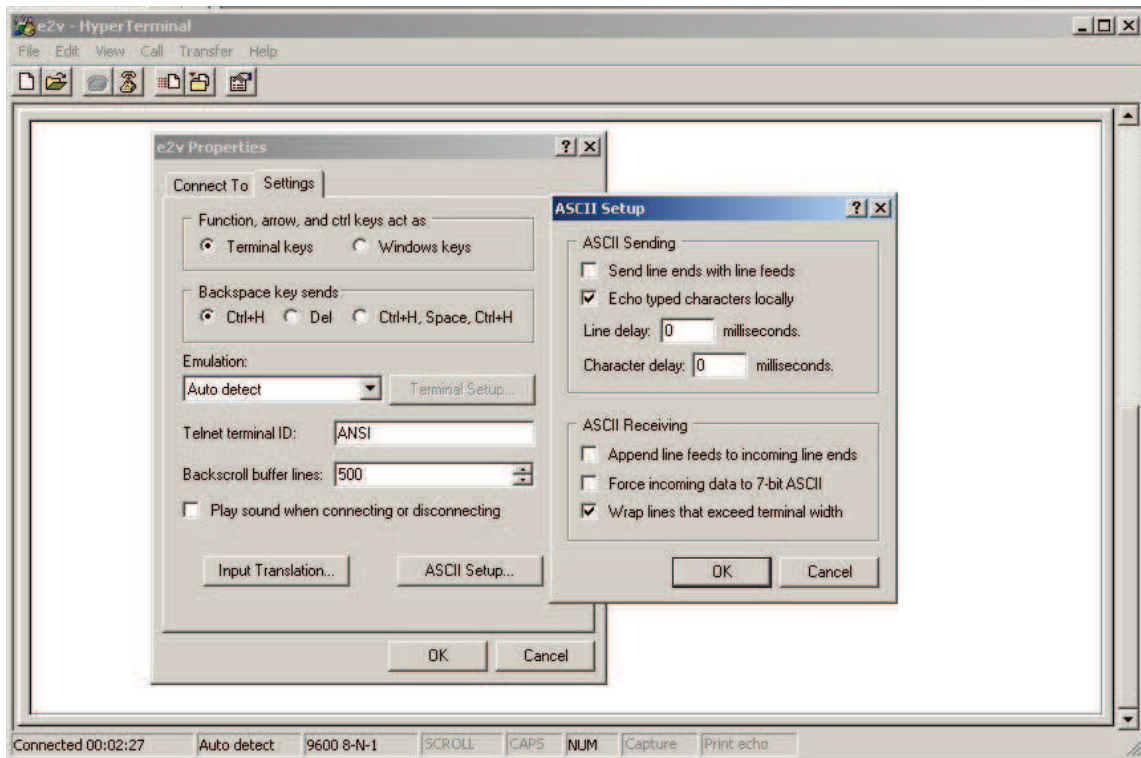

- Type [WHO] and a response should be received from the Evaluation Kit giving the firmware version and checksum.

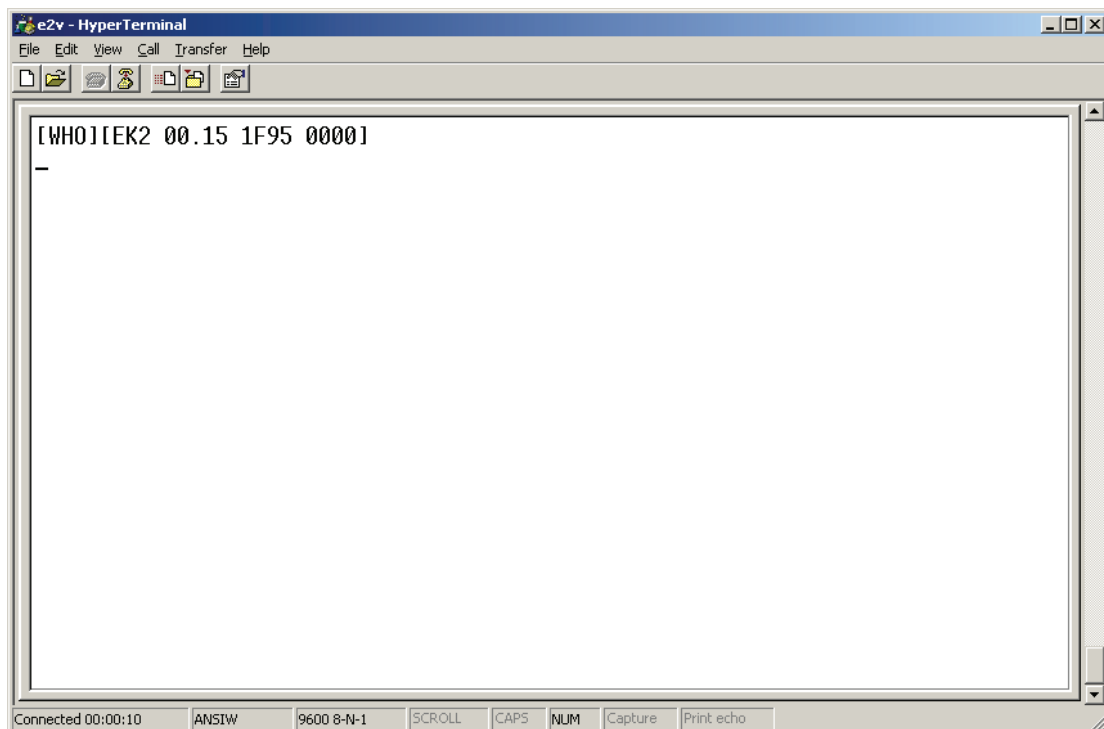

Note that if the Evaluation Kit is already set in 'Measurement Mode' then a data packet will be displayed once per second. A full list of HyperTerminal commands can be found in Section 16.

5 User Interfaces, Controls and Indicators

5.1 Power Supply (SK4, TB1)

The Evaluation Kit requires a $9\text{ V} \pm 10\%$ power supply. Either connect the supplied 9 V DC mains adapter to SK4 or a $9\text{V} \pm 10\%$ laboratory supply to the terminal block TB1.

The supplied power supply adapter is double insulated, indicated by the double square symbol. If the Evaluation Kit is used with a power supply which is not double insulated, connect a Protective Earthing Connection to the Protective Earth terminal on the PCB indicated by the Protective Earth symbol in case of power supply faults.



5.2 USB Interface (SK5)

SK5 is a type B Mini-USB connector for communicating with a PC.

5.3 Gas Sensors Sockets (S1, S2)

The Evaluation Kit can drive one gas sensor which should be fitted in either S1 or S2 as follows:

- S1: 6-pin or 7-pin (single gas) sensor
- S2: 8-pin (twin gas) sensor

5.4 Signal Monitor (PL3)

PL3 is a signal monitor port. It allows the amplified channel signals and the bulb drive control to be monitored on an oscilloscope.

1	Reference signal monitor
2	0 V
3	Active 1 signal monitor
4	0 V
5	Active 2 signal monitor
6	0 V
7	Bulb control (3V3 logic)
8	0 V

5.5 User Adjustments (VR0, VR1, VR2, VR3)

- VR0: Reference channel gain adjust
- VR1: Active channel 1 gain adjust
- VR2: Active channel 2 gain adjust
- VR3: Lamp drive voltage (3.0 V to 5.0 V)

5.6 JTAG Port (PL1)

The JTAG Port can be used by engineers wishing to develop their own software for the Evaluation Board. The socket will connect to a Texas Instruments MSP430 Debug Interface, e.g. MSP-FET430UIF, for reprogramming and debugging.

TDO	1	2	VCCO
TDI	3	4	VCCI
TMS	5	6	Unused
TCK	7	8	Unused
0 V	9	10	Unused
TRST	11	12	Unused
Unused	13	14	Unused

5.7 Expansion Port (PL2)

PL2 is an expansion port allowing connection to additional peripherals. The port provides access to the input and 3.3 V supplies, four open collector outputs, four digital inputs, two analogue outputs and a spare UART connection.

3V3 Regulated Power	1	2	9 V Unregulated Power
0 V	3	4	0 V
Input 1 (3V3 logic)	5	6	Output 1 (Open collector)
Input 2 (3V3 logic)	7	8	Output 2 (Open collector)
Input 3 (3V3 logic)	9	10	Output 3 (Open collector)
Input 4 (3V3 logic)	11	12	Output 4 (Open collector)
0VA	13	14	Analogue Output 1 (0 to 2.048 V)
0VA	15	16	Analogue Output 2 (0 to 2.048 V)
Serial RXD (3V3)	17	18	Serial TXD (3V3)
0V	19	20	Not used

5.8 LEDs (D1, D2, D3, D4, D5)

D1, D2, D3 and D4 indicate the state of each open collector output on the Expansion Port.

D5 flashes to indicate that the power is on and the software is operating normally.

5.9 Reset Switch (SW2)

Press and release SW2 to reset the microcontroller. This has the same function as removing and reconnecting the power supply.

PCB Layout:

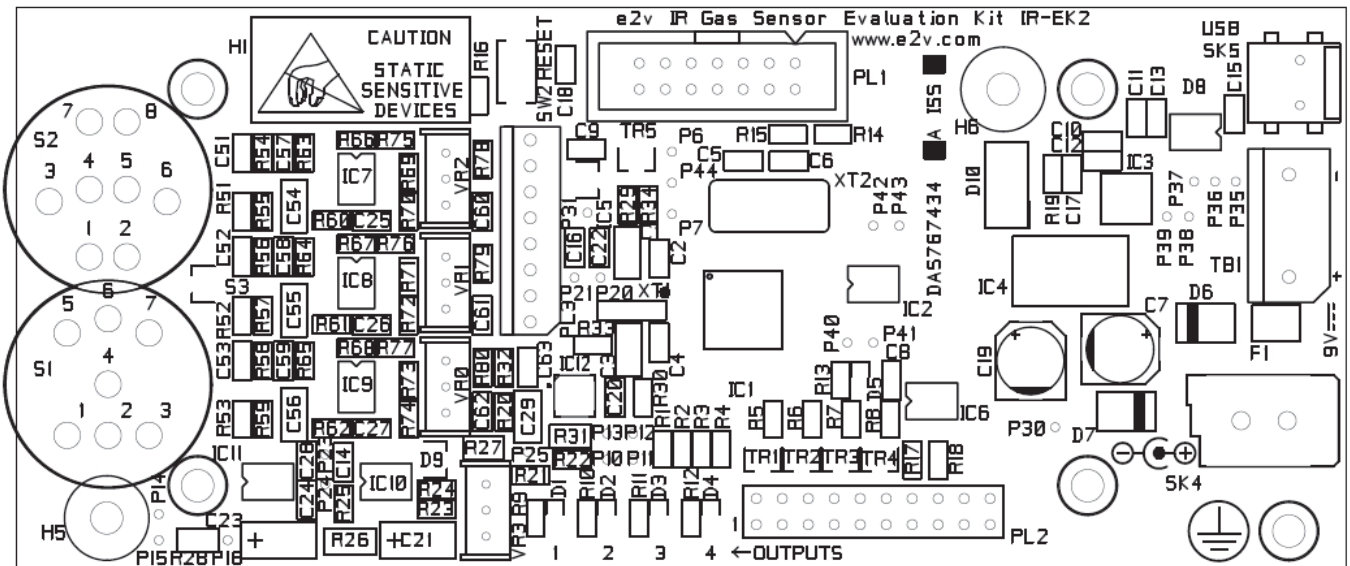

6 Operating Modes

6.1 Introduction

The Evaluation Kit has two operating modes, 'Measurement Mode' and 'Device Setup Mode'. To switch between them, click on the appropriate radio button near the top left hand panel of the screen.

6.2 Measurement Mode

In order to take readings from the Evaluation Kit it must be in Measurement Mode. The PC Software will automatically switch the IR-EK2 into Measurement Mode when it is first connected, even if it was previously left in Device Setup Mode.

In Measurement Mode the Evaluation Kit sends readings to the PC once per second of the following:

- Peak-to-peak signal (Reference Channel)
- Peak-to-peak signal (Active Channel A)
- Peak-to-peak signal (Active Channel B)*
- Concentration (Channel A)
- Concentration (Channel B)*
- Bulb voltage
- Temperature

* Only applicable to twin-gas devices

As the Evaluation Kit operates at a 4 Hz signal frequency, the peak-to-peak and concentration readings are an average of the four measurements in the previous second.

6.3 Device Setup Mode

In order to change any of the programmable operating parameters of the Evaluation Kit it must be in Device Setup Mode. In this mode it is possible to adjust all of the following:

- Lamp mode (pulsing, on, off)
- Sensor type (single gas, twin gas)
- Temperature sensor type (thermistor, IC)
- Sampling delay time (time from bulb change to ADC sampling)
- Temperature compensation and calibration coefficients

The following sections describe how all these parameters can be set up.

7 Lamp Drive

7.1 Frequency

The Evaluation Kit drives the sensor lamp at a 4 Hz frequency. This is the frequency recommended by SGX for driving infrared gas sensors. The lamp control waveform can be monitored on an oscilloscope at PL3 pin 7 (pin 8 is 0 V).

7.2 Voltage

The lamp voltage can be changed on the circuit board by adjusting VR3. In 'Measurement Mode' the lamp voltage is measured and displayed on the 'Readings' tab.

The adjustment range will cover at least 3.0 V to 5.0 V. A 5.0 V lamp drive will give maximum infrared emission and the best system performance. Heat from the bulb will also keep the temperature of the optical reflector higher than ambient which is helpful in preventing condensation in humid environments. For battery powered portable instruments the sensors can also be operated very successfully with a 3.0 V lamp drive. Although the sensitivity to gas will be smaller, the power consumption will be less and the bulb lifetime increased. The graph below shows how the pyro outputs change with bulb voltage.

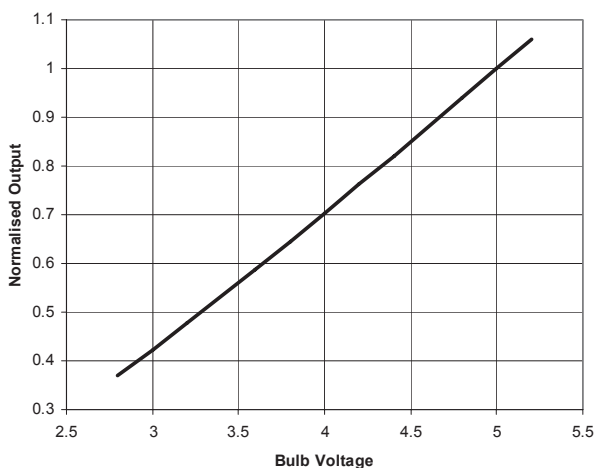

Pyro Output Voltage vs. Lamp Supply (IR12GJ Active Channel, Normalised at 5.0 V)

The bulb has a very low resistance when cold (turned off). This can cause a current surge at the instant of turn-on which might be undesirable in certain applications. This is mainly a problem when the equipment is turned on from cold – once the bulb is being driven at 4 Hz it maintains some heat even when 'off' to reduce this effect. It is possible to monitor the bulb current by monitoring the voltage across R26 (10R) using test points P16 and P24.

Some users reduce this current surge by biasing the bulb at about 0.4 V when 'off' to keep it just warm. This can be done on the IR-EK2 by fitting a 330R 0805 resistor in the empty R27 position (between VR0 and VR3).

8 Channel Gains

A gas sensing instrument normally has fixed channel gains. However, the IR-EK2 is designed to operate with a wide range of sensors having different output levels so adjustable gain settings have been provided for optimum performance.

The channel gains should be adjusted *after* setting the lamp voltage as follows:

- VR0 – Reference channel
- VR1 – Active channel A
- VR2 – Active channel B

These are best adjusted while monitoring the signals with an oscilloscope at the signal monitor PL3. Best performance will be obtained with the signals as high as possible. However the circuit will clip at 3 V so a setting of about 2 V peak-to-peak is suggested.

The channel amplifiers have the frequency response shown right. The gain is approximately 40 at 4 Hz when the variable resistors are at their minimum setting and all channels will have identical gain.

At the maximum setting the channel gains will be around 400, but component tolerances may cause some small variation between channels.

If an oscilloscope is not available then the peak-to-peak levels are displayed on the 'Readings' tab when in Measurement Mode. However, if the ADC measurement delay time is not correctly set up then these may not be accurate. The timing diagram shows that there is a delay between the bulb switching point and the maximum or minimum of the signal response. This delay is typically around 20 – 25 ms but will depend on the model of gas sensor being used. The delay is related to the output level of the pyro devices and it may be observed that when the bulb drive is reduced from 5 V to 3 V the delay time will increase slightly. If an oscilloscope is not available then a process of trial and error can be used to determine the optimum delay time.

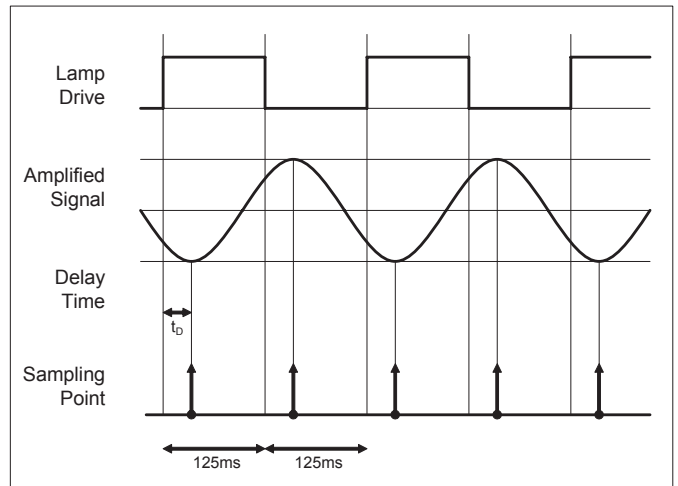
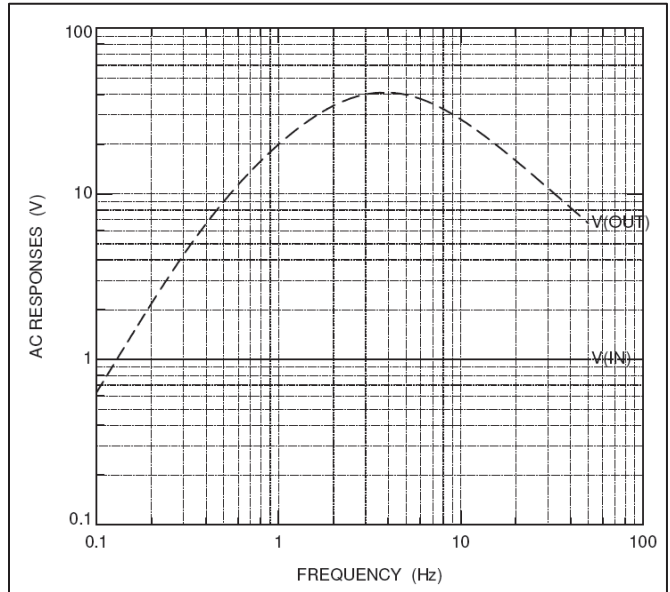

On some sensors where there is a difference in output level between the active and reference channels there will be a difference in delay time for each channel. In this situation the delay time should be set to the average value. The following section explains how to set the ADC measurement delay time and other sensor specific parameters.

9 Sensor Set-up

Sensor specific settings are set up in the 'Coefficient Editor' which can be found on the 'Calibration' tab. The Coefficient Editor can only be entered in 'Device Setup Mode'. In the Coefficient Editor the following parameters can be set up:

Sensor Channels	'Single': Single gas sensor plugged into S1 (reference and one active channel) 'Dual': Dual gas sensor plugged into S2 (reference and two active channels)	
Time Delay (ms)	Delay from bulb switch to ADC sampling point. See Section 8	
Temperature Sensor	There are three different types of temperature sensors fitted to e2v infrared gas sensors. It is important to select the correct type so that the temperature readings are accurate. Some sensors have no integrated temperature sensor and so the PCB mounted sensor should be selected. The following options are available: <ul style="list-style-type: none"> • External IC - uses IC temperature sensor on the IR-EK2 PCB • Internal Thermistor (Twin Gas) – thermistor on twin gas devices • Internal Thermistor (Single Gas) – thermistor on some single gas devices • Internal IC – IC sensor used on some single gas devices 	
Concentration Range 1/2/3	Some of the calibration coefficients for measuring concentration over a wide range (e.g. 100% CO ₂) will be slightly different to those used for a narrow range (e.g. 5% CO ₂) to give the optimum accuracy. The evaluation kit can store three sets of calibration coefficients for each gas channel. The 'Select' button allows you to select which range is in use.	
Concentration range (ppm)	The upper limit of each concentration range. Note: 1000 ppm = 0.1% volume	
a	Linearisation coefficient	For more information about calibration coefficients and how to calculate them see Infrared Sensor Applications Notes 2 and 5 available from www.e2v.com
n	Linearisation coefficient	
Betapos	Span variation over positive temperature	
Betaneg	Span variation over negative temperature	
Alphapos	Zero variation over positive temperature	
Alphaneg	Zero variation over negative temperature	
Span concentration	The concentration of the calibration gas used when performing the 'span' calibration	

Button Functions

Load File:	Loads a set of coefficients from the indicated file on the PC
Refresh List:	Updates the list of available coefficient files
Send to Unit:	Sends the data from the Coefficient Editor to the Evaluation Kit
Get Parameters From Unit:	Reads the data currently stored in the Evaluation Kit and displays it on the Coefficient Editor
Save Data to File:	Saves the data from the Coefficient Editor to a file on the PC
Exit:	Exits the Coefficient Editor

When the software is installed, coefficient files for a number of devices will be available on the PC. See the e2v website for any updates if available. These coefficients have typically been generated for a 5V bulb voltage but if a different lamp voltage, delay time or change in electronics is used then the coefficients may not be accurate. Customers are strongly advised to recalculate their own coefficients to suit the performance of their own instrument design. See IR Application Notes on the SGX website for more information about coefficients.

10 Calibration

Before performing calibration, the following activities should have already been completed:

- Set lamp drive voltage, VR3 (Section 7)
- Set the channel gains, VR0, VR1, VR2 (Section 8)
- Set the sensor type, temperature sensor type and coefficients (Section 9)

A two point calibration is performed by setting the 'zero' and 'span' levels when in 'Measurement Mode'. It is recommended that the Evaluation Kit be turned on and driving the sensor for at least 30 minutes so that the system can temperature stabilise before calibrating.

Set Zero A source of dry nitrogen should be used to set the zero level. Once the gas is passing over the sensor, press the 'Set Zero' button on the 'Calibration' tab.

Set Span A source of the target gas with known concentration is required to set the span. Note that the concentration does not need to be the same as the span range. The 'Span Concentration' level in the Coefficient Editor should be adjusted to be equal to the concentration of the calibration gas. Once the gas is passing over the sensor, press the 'Set Span' button on the 'Calibration' tab.

Each zero and span calibration will take about 10 seconds as averaging is used to increase accuracy. This period is independent of the averaging time set in the PC software.

The above procedure should be repeated for the second gas if a twin-gas sensor is used. The gas sensing system is now calibrated and the correct level of gas concentrations will be displayed on the PC screen.

11 Analog Outputs

The outputs of two 12 bit digital to analog converters (DACs) are provided on the expansion port PL2. Each analogue output is buffered by an operational amplifier and can give outputs in the range 0 V (000 hex) to 2.048 V (FFF hex). The analog outputs can be configured on the 'I/O' tab which is only available in 'Device Setup Mode'.

Button Functions (I/O Tab)

Write Value:	Fixes the DAC output at a fixed voltage level set on the PC Software
Reference Pk-Pk:	DAC tracks the Reference Peak to Peak value (Note: DAC 0 V - 2.048 V output corresponds to 0 V – 3 V input range)
Channel A/B Pk-Pk:	DAC tracks the Active Channel Peak to Peak value (Note: DAC 0 V - 2.048 V output corresponds to 0 V – 3 V input range)
Channel A/B Conc:	DAC tracks the Concentration value (Note: DAC 0 V - 2.048 V output corresponds to Zero – Span input range)

12 Alarm Outputs and LEDs

Four open collector alarm outputs are provided on the expansion port PL2. Each alarm has an associated LED (D1-D4) to indicate the status of the alarm output.

To use the open collector outputs, a resistor or other load should be connected to the desired external voltage. The 9 V input and 3V3 microcontroller supply are also available on the expansion connector for this purpose.

LED ON = alarm enabled (open collector driven - low)
LED OFF = alarm disabled (open collector released – high)

The 'Alarms' tab is only visible when in 'Device Setup Mode'
Each of the four alarm outputs can be set to one of the following options:

- Monitor Gas
The alarm can be set to come on when the concentration is above or below a particular concentration level on either Channel A or Channel B.
- Force Alarm ON
- Force Alarm OFF
- Follow Input
The alarm will follow the value of the corresponding digital input (used for testing)

Click 'Refresh Settings' to read the current settings from the PCB.

Click 'Write All Alarm Settings' to write new alarm settings to the PCB.

Note that when the alarms are set to monitor concentration levels they use the one second averaged values, independent of what averaging is set on the PC data logging software.

13 Digital Inputs

Four digital inputs are provided on the expansion port PL2. They can be used by engineers writing their own application software to run on the Evaluation Kit. The status of each digital input can be viewed on the 'I/O' tab which is only present in 'Device Setup Mode'

14 Appendix: Evaluation Kit PCB Schematic Diagram

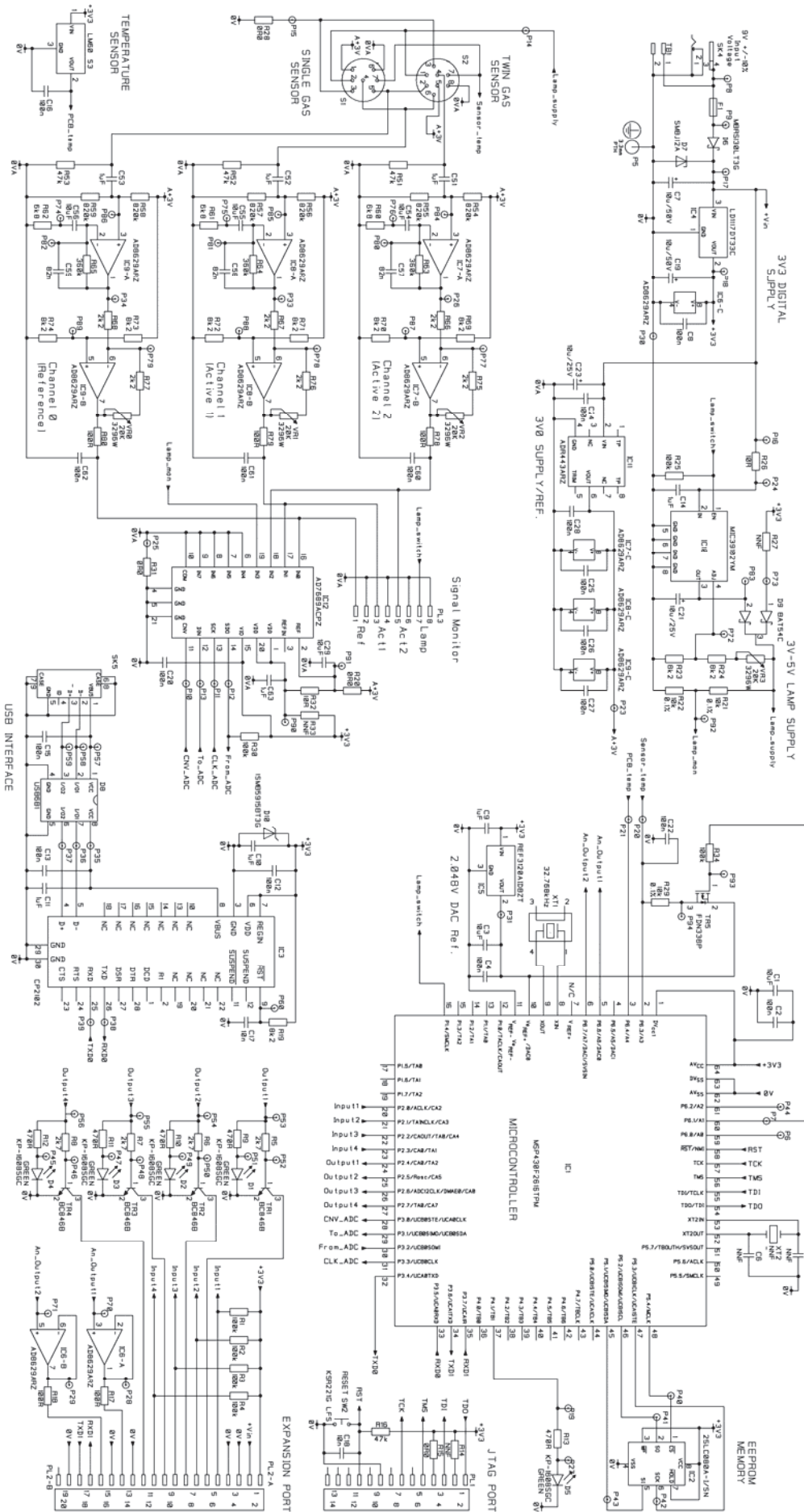

15 Appendix: Evaluation Kit PCB Parts List

Item	Description	Manufacturer	Part No.	Qty	Reference
1	Blank PCB, DPP767434AA Issue 2	Any manufacturer		1	HW1
2	Feet, stick on, black, 11.1mm dia.	3M	SJ5003BLACK	4	HW2, HW3, HW4, HW5
3	Resistor 0603 0.063W 1% 0R0	Any manufacturer		2	R15, R20
4	Resistor 0603 0.063W 1% 10R	Any manufacturer		1	R32
5	Resistor 0603 0.063W 1% 100R	Any manufacturer		5	R17, R18, R78, R79, R80
6	Resistor 0603 0.063W 1% 470R	Any manufacturer		5	R9, R10, R11, R12, R13
7	Resistor 0603 0.063W 1% 2k2	Any manufacturer		6	R66, R67, R68, R75, R76, R77
8	Resistor 0603 0.063W 1% 2k7	Any manufacturer		4	R5, R6, R7, R8
9	Resistor 0603 0.063W 1% 6k8	Any manufacturer		3	R60, R61, R62
10	Resistor 0603 0.063W 1% 8k2	Any manufacturer		9	R19, R23, R24, R69, R70, R71, R72, R73, R74
11	Resistor 0603 0.063W 1% 47k	Any manufacturer		4	R16, R51, R52, R53
12	Resistor 0603 0.063W 1% 100k	Any manufacturer		7	R1, R2, R3, R4, R25, R30, R34
13	Resistor 0603 0.063W 1% 360k	Any manufacturer		3	R63, R64, R65
14	Resistor 0603 0.063W 1% 820k	Any manufacturer		6	R54, R55, R56, R57, R58, R59
15	Resistor 0603 0.063W 0.1% 25ppm 10k	Any manufacturer		3	R21, R22, R29
16	Resistor 0805 0.1W 1% 0R0	Any manufacturer		2	R28, R31
17	Resistor 1206 0.125W 1% 10R	Any manufacturer		1	R26
18	Resistor Variable 20k 0.5W Multiturn	Bourns	3296W-1-203LF	4	VR0, VR1, VR2, VR3
19	Capacitor Cer. 0603 X7R 50V 10% 10nF	Any manufacturer		2	C17, C18
20	Capacitor Cer. 0603 X7R 16V 10% 82nF	Any manufacturer		3	C57, C58, C59
21	Capacitor Cer. 0603 X7R 50V 10% 100nF	Any manufacturer		17	C2, C4, C8, C12, C13, C15, C16, C20, C22, C24, C25, C26, C27, C28, C60, C61, C62
22	Capacitor Cer. 0603 X7R 16V 10% 1uF	Any manufacturer		8	C9, C10, C11, C14, C51, C52, C53, C63
23	Capacitor Cer. 1206 X7R 6.3V 10% 10uF	Any manufacturer		6	C1, C3, C29, C54, C55, C56
24	Capacitor Alum. Elec 50V 20% 10uF	Panasonic	EEE1HA100SP	2	C7, C19
25	Capacitor Tant. TPSC 25V 10% 10uF	AVX	TPSC106K025R0500	2	C21, C23
26	Diode Schottkyx2 SOT23-5 BAT54C	Any manufacturer	BAT54C	1	D9
27	Diode LED Green SMD	Kingbright	KP-1608SGC	5	D1, D2, D3, D4, D5
28	Diode Schottky 1A 30V SMB	On-Semi	MBRS130LT3G	1	D6
29	Diode TVS 12V 600W	Any manufacturer	SMBJ12A	1	D7
30	Diode Pack TVS 6V 500W	ST-Micro	USB6B1	1	D8
31	Diode Zener 3V9 3W	OnSemiconductor	1SMB5915BT3G	1	D10
32	Transistor NPN SOT23	NXP	BC846B	4	TR1, TR2, TR3, TR4
33	IC Micro 16 bit 64LQFP	Texas **	MSP430F2616TPM	1	IC1
34	IC Serial Eeprom SO8	Microchip	25LC80A-I/SN	1	IC2
35	IC USB to UART Bridge MLP-28	Silicon Labs	CP2102	1	IC3
36	IC Regulator 3V3 DPAK	ST	LD1117DT33C	1	IC4
37	IC Reference 2.048V SOT23	Texas	REF3120AIDBZT	1	IC5
38	IC Op-amp Rail-to-rail I/O SO8	Analog	AD8629ARZ	4	IC6, IC7, IC8, IC9
39	IC Regulator Adj SO8	Micrel	MIC39102YM	1	IC10
40	IC Reference 3.0V SO8	Analog	ADR443ARZ	1	IC11
41	IC ADC 8x16bit 20QFN	Analog	AD7689ACPZ	1	IC12
42	Connector Press Mount Socket	Wearnes Cambion	450-1804-01-03-00	15	S1 (7 off), S2 (8 off)
43	IC Temp. Sensor SOT23	National	LM60BIM3	1	S3
44	Connector SKT DC Power 2.5mm	Lumberg	1613 14	1	SK4
45	Connector SKT USB Mini Type B	Molex	675031020	1	SK5
46	Connector PLG 14 Way Box Header	Amp	1-1634688-4	1	PL1
47	Connector 2x10 Way 2.54mm	Harwin	M20-9981045	1	PL2
48	Connector 8 Way Vertical Friction Lock	Molex	22-27-2081	1	PL3
49	Fuse Polyswitch 500mA Hold	Tyco	MICROSMD050F	1	F1
50	Terminal Block 2 Way	Elkay	15001/2	1	TB1
51	Switch Push button SMD	C&K	KSR221G LFS	1	SW2
52	Crystal SMD 32.768kHz	Epson Toyocom	MC-146 32.768kHz +/-20ppm 7.0pF	1	XT1
53	Transistor MOSFET P-Channel SOT23	Fairchild	FDN338P	1	TR5
	Components not fitted:				
	Capacitor Ceramic 0603			2	C5, C6
	Resistor SMD 0603			1	R14, R33
	Resistor SMD 0805			1	R27
	Crystal HC49/4H			1	XT2

16 Appendix: Serial Message Protocol

Enquire Status	Command	Response	Notes	Available in Mode
PCB	[WHO]	[EK2 aa.bb cccc dddd]	aa.bb Software version cccc Software checksum dddd Serial number	Set-up
Lamp	[EK2 LMP ENQ]	[EK2 LMP aaa]	aaa Lamp setting: OFF, ONX, PLS	Set-up
Analog Out (DAC)	[EK2 DA1 ENQ]	[EK2 DA1 aaa bbb]	aaa DAC setting: 000-FFF, M00, M01, M02	Set-up
	[EK2 DA2 ENQ]	[EK2 DA2 aaa bbb]	bbb DAC output: 000-FFF	Set-up
Alarms (individual)	[EK2 AL1 ENQ]	[EK2 AL1 aaa bbb ccccccc]	aaa Alarm status ONX, OFF bbb Alarm setting: MAN, FOL, 1GT, 1LT, 2GT, 2LT cccccccc Alarm threshold 0000000-1000000 (ppm)	Set-up
	[EK2 AL2 ENQ]	[EK2 AL2 aaa bbb ccccccc]		Set-up
	[EK2 AL3 ENQ]	[EK2 AL3 aaa bbb ccccccc]		Set-up
	[EK2 AL4 ENQ]	[EK2 AL4 aaa bbb ccccccc]		Set-up
Alarms (all)	[EK2 AL0 ENQ]	[EK2 AL0 aaa bbb ccc ddd]	aaa Alarm 1 output ONX, OFF bbb Alarm 2 output ONX, OFF ccc Alarm 3 output ONX, OFF ddd Alarm 4 output ONX, OFF	Set-up
Digital Inputs	[EK2 DIN ENQ]	[EK2 DIN abcd]	a Digital Input 1 status: 0, 1 b Digital Input 2 status: 0, 1 c Digital Input 3 status: 0, 1 d Digital Input 4 status: 0, 1	Set-up
Calibration Table	[EK2 CAx ENQ]	[EK2 CAx aaaaaa aaaaaa aaaaaa bbcc bbcc bbcc ddde ddde ddde fgggh ijijk lmmmn lmmmn lmmmn opppq opppq opppq rrrs ttu vvvvvv www xxx y z]	x Channel A or B aaaaaa Concentration range (3 for each chan) bbcc A coefficient bbb x 10 ^{-c} (3 for each ch) ddde N coefficient, as above fgggh Alphapos (f = +/-), as above ijijk Alphaneg lmmmn Betapos opppq Betaneg rrrs Zero (to 3 significant figures) ttu Span (to 3 significant figures) vvvvvv Span gas concentration www Delay time (ms) xxx Current Range y Temp sensor type z S or D (single or duel type sensor)	Set-up
Zero Value (greater accuracy)	[EK2 CAx ZERO ENQ]	[EK2 CAx ZERO aa.aaaaa]	X Channel A or B aa.aaaaa Value to 6 decimal places	Set-up
Span Value (greater accuracy)	[EK2 CAx SPAN ENQ]	[EK2 CAx SPAN aa.aaaaa]	X Channel A or B aa.aaaaa Value to 6 decimal places	Set-up
Set Lamp	Command	Response	Notes	
Lamp off	[EK2 LMP OFF]	[ACK]		Set-up
Lamp on	[EK2 LMP ONX]	[ACK]		Set-up
Lamp pulsing	[EK2 LMP PLS]	[ACK]		Set-up
Set Mode	Command	Response	Notes	
Measurement Mode	[EK2 SEN MEA]	Output every second [EK2 SEN aaaa bbbb cccc ddddddd eeeeeee ffff gggg]	aaaa Reference pk-pk 1s mean: 0000-FFFF (hex) bbbb Active ChA pk-pk 1s mean: 0000-FFFF (hex) cccc Active ChB pk-pk 1s mean: 0000-FFFF (hex) ddddddd Concentration ChA 1s (ppm) eeeeeee Concentration ChB 1s (ppm) ffff Temperature reading °C: -99.9 to +99.9 or ERR gggg Bulb Voltage pk-pk 1s mean: 0000-FFFF (hex)	Set-up
Set-up Mode	[EK2 SEN SET]	[ACK]		All
Set DAC	Command	Response	Notes	
Fixed value	[EK2 DA1 aaa]	[ACK]	aaa 000-FFF	Set-up
	[EK2 DA2 aaa]	[ACK]		Set-up
Automatic mode	[EK2 DA1 Maa]	[ACK]	aa 00: Track reference ADC 01: Track Active ADC 02: Track Concentration	Set-up
	[EK2 DA2 Maa]	[ACK]		Set-up
Set Alarms	Command	Response	Notes	Available in mode
Manual On (individual: 1-4) (all together: 0)	[EK2 AL1 MAN ONX]	[ACK]		Set-up
	[EK2 AL2 MAN ONX]	[ACK]		Set-up

	[EK2 AL3 MAN ONX]	[ACK]		Set-up
	[EK2 AL4 MAN ONX]	[ACK]		Set-up
	[EK2 AL0 MAN ONX]	[ACK]		Set-up
Manual Off (individual: 1-4) (all together: 0)	[EK2 AL1 MAN OFF]	[ACK]		Set-up
	[EK2 AL2 MAN OFF]	[ACK]		Set-up
	[EK2 AL3 MAN OFF]	[ACK]		Set-up
	[EK2 AL4 MAN OFF]	[ACK]		Set-up
	[EK2 AL0 MAN OFF]	[ACK]		Set-up
Follow digital inputs (individual: 1-4) (all together: 0)	[EK2 AL1 FOL]	[ACK]		Set-up
	[EK2 AL2 FOL]	[ACK]		Set-up
	[EK2 AL3 FOL]	[ACK]		Set-up
	[EK2 AL4 FOL]	[ACK]		Set-up
	[EK2 AL0 FOL]	[ACK]		Set-up
On if Channel a concentration is Greater Than bbbbbbb (individual: 1-4) (all together: 0)	[EK2 AL1 aGT bbbbbbb]	[ACK]	a Channel: 1 or 2	Set-up
	[EK2 AL2 aGT bbbbbbb]	[ACK]	bbbbbbb Concentration	Set-up
	[EK2 AL3 aGT bbbbbbb]	[ACK]		Set-up
	[EK2 AL4 aGT bbbbbbb]	[ACK]		Set-up
	[EK2 AL0 aGT bbbbbbb]	[ACK]		Set-up
On if Channel a concentration is Less Than bbbbbbb (individual: 1-4) (all together: 0)	[EK2 AL1 aLT bbbbbbb]	[ACK]		Set-up
	[EK2 AL2 aLT bbbbbbb]	[ACK]		Set-up
	[EK2 AL3 aLT bbbbbbb]	[ACK]		Set-up
	[EK2 AL4 aLT bbbbbbb]	[ACK]		Set-up
	[EK2 AL0 aLT bbbbbbb]	[ACK]		Set-up
System	Command	Response	Notes	
Invalid command	Invalid command	[NAK]		Set-up
Calibration	Command	Response	Notes	
Set temp sensor type	[EK2 CAL TEM aa]	[ACK]	aa Sets the temp sensor type – e.g. 00= Use PCB temperature sensor 01 = Twin Gas Thermistor 02 = IrxxEx Thermistor 03 = LM60 internal to sensor (IRxxGx)	Set-up
Set the zero	[EK2 CAX ZERO]	[ACK]	x A = Channel A B = Channel B	
Set the span	[EK2 CAX SPAN]	[ACK]	x A = Channel A B = Channel B	
Set span concentration gas	[EK2 CAX SCG aaaaaaa]	[ACK]	aaaaaaa span concentration gas (ppm)	Set-up
Set number of sensor channels	[EK2 CAL aCH]		a 1 or 2	Set-up
Set concentration Range	[EK2 CAX RA1 aaaaaaa]	[ACK]	aaaaaaa Sets concentration range to aaaaaaa ppm	Set-up
	[EK2 CAX RA2 aaaaaaa]	[ACK]	x A = Channel A B = Channel B	Set-up
	[EK2 CAX RA3 aaaaaaa]	[ACK]		Set-up
Set A coefficient	[EK2 CAX A1 aab]	[ACK]	aaab co-efficient a = $aaa \times 10^{-b}$	Set-up
	[EK2 CAX A2 aab]	[ACK]	A = Channel A B = Channel B	Set-up
	[EK2 CAX A3 aab]	[ACK]		Set-up
Set n coefficient	[EK2 CAX N1 aaaa]	[ACK]	aaa co-efficient n = $aaa \times 10^{-b}$ x A = Channel A B = Channel B	Set-up
Set n coefficient	[EK2 CAX N2 aaaa]	[ACK]	aaab co-efficient n = $aaa \times 10^{-b}$	Set-up
	[EK2 CAX N3 aaaa]	[ACK]	x A = Channel A B = Channel B	Set-up

Set Alphapos coefficient	[EK2 Cx ALPHA saaaa]	[ACK]	aaab s x	co-efficient alpha = $aaa \times 10^{-b}$ Sign +/- A = Channel A B = Channel B	Set-up
Set Alphaneg coefficient	[EK2 Cx ALPHAN saaaa]	[ACK]	aaab s x	co-efficient alpha = $aaa \times 10^{-b}$ Sign +/- A = Channel A B = Channel B	Set-up
Set Beta coefficient	[EK2 Cx BETA1 saaaa]	[ACK]	aaab s x	co-efficient beta = $aaa \times 10^{-b}$ Sign +/- A = Channel A B = Channel B	Set-up
	[EK2 Cx BETA2 saaaa]	[ACK]			Set-up
	[EK2 Cx BETA3 saaaa]	[ACK]			Set-up
Set Betaneg coefficient	[EK2 Cx BETA1N saaaa]	[ACK]	aaab s x	co-efficient beta = $aaa \times 10^{-b}$ Sign +/- A = Channel A B = Channel B	Set-up
	[EK2 Cx BETA2N saaaa]	[ACK]			Set-up
	[EK2 Cx BETA3N saaaa]	[ACK]			Set-up
Use medium concentration range parameters	[EK2 Cx RMI]	[ACK]	x	A = Channel A B = Channel B	Set-up
Use high concentration range parameters	[EK2 Cx RHI]	[ACK]	x	A = Channel A B = Channel B	Set-up

17 Appendix: China RoHS Declaration



	零件项目(名称) (Component Name) IR-EK2 Evaluation Kit	有毒有害物质或元素 (Hazardous Substances or Elements)					
		铅 Lead (Pb)	汞 Mercury (Hg)	镉 Cadmium (Cd)	六价铬 Chromium VI Compounds (Cr6+)	多溴联苯 Poly- brominated Biphenyls (PBB)	多溴二苯醚 Poly- brominated Diphenyl Ethers (PBDE)
1	印制电路配件 (Printed Circuit Assemblies) DAS767434AA Evaluation Kit PCB	O	O	O	O	O	O
2	外接电(线)缆 (External Cables) E100918 USB Lead	O	O	O	O	O	O
3	电源供应器 (Power Supply Unit) DAS766693AA Power Supply Unit	O	O	O	O	O	O
4	文件说明书 (Paper Manuals) DF767801A Quick Start Guide	O	O	O	O	O	O
5	光盘说明书 (CD Manual) CD-ROM Manual/Software	O	O	O	O	O	O
<p>O: 表示该有毒有害物质在该部件所有均质材料中的含量均在 SJ/T 11363-2006标准规定的限量要求以下。 O: Indicates that this toxic or hazardous substance contained in all of the homogeneous materials for this part is below the limit requirement in SJ/T11363-2006.</p> <p>X: 表示该有毒有害物质至少在该部件的某一均质材料中的含量超出 SJ/T 11363-2006标准规定的限量要求。 X: Indicates that this toxic or hazardous substance contained in at least one of the homogeneous materials used for this part is above the limit requirement in SJ/T11363-2006</p>							

18 Appendix: Updating the IR-EK2 Embedded Software

From time to time SGX may release updates to the PC datalogging software or the embedded software (firmware) which runs on the IR-EK2 microprocessor. These will normally be available for download from the SGX website www.SGX.com. To install a new version of embedded software on the IR-EK2, follow these instructions very carefully:

1. Download the firmware zip file. Unzip and save the text file (ir_ek2_.....txt) to the computer hard drive.
2. Connect up the IR-EK2 evaluation kit to the PC via the USB lead and connect the power.
3. Run the PC software (installed from the supplied CD)
4. Make sure the device is shown as connected.
5. Change the mode to 'Device Setup Mode'
6. Select the 'Hardware' menu, then 'Update Firmware'
7. Click 'Start Update'
8. Select the firmware file (ir_ek2_.....txt) on the computer hard drive
9. Click OK

****** Warning: Do not disconnect device during update ******

10. When the progress bar has completed, the installation is complete. The new version number will be shown on the PC screen.

Please read any compatibility notes provided in the readme.txt file supplied in the zip file. It may be necessary to upgrade to a later version of PC software at the same time.