

This application note contains additional information on the characteristics of the MiCS-2610 ozone gas sensor. A typical application consists of measuring the ozone level indoors close to an ozone-generating source or outdoors to detect disturbing or harmful concentrations of ozone in the air. The sensor is usually placed inside a housing to protect the sensing element from water and dust projections. Ambient air containing ozone reaches the sensing element by gas diffusion. A change of the electric resistance of the sensing layer can be converted into a voltage change. This voltage change can then be used to calculate an equivalent concentration of ozone by using a microcontroller or simply to display or sound an alarm by comparing the voltage from the sensor with a pre-set threshold voltage (see Fig. 1).

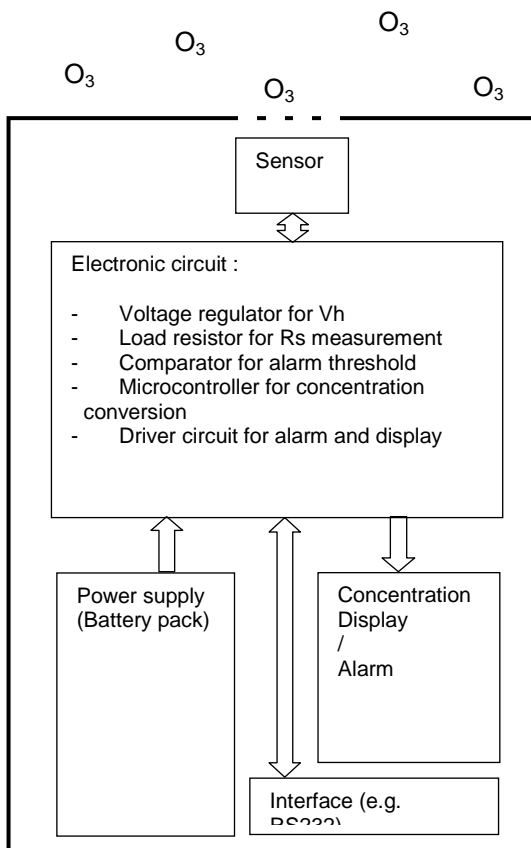

**Fig. 1: Schematic of a portable ozone detection system with built-in alarm**

## OPERATING CONDITIONS

The MiCS-2610 ozone gas sensor is designed to meet the requirements listed in the table below:

Parameter	Symbol	Typ	Min	Max	Unit
Life time	tl	5	5	-	year
Switch on/off cycles	n <sub>cycle</sub>	100'000	100'000	-	-
Heating power	P <sub>H</sub>	70	-	-	mW
Relative humidity range	RH	50	5	95	%RH
Ambient operating temperature	T <sub>amb</sub>	20	-40	70	°C

## MEASUREMENT CIRCUIT

The sensor module can be powered with 5 V as shown in Fig. 2. In order to obtain a nominal heating power of 70 mW, a resistor R<sub>serial</sub> of 88 Ω is connected in series with the heating resistor R<sub>heater</sub>. R<sub>S</sub> can then be calculated by the following expression:

$$R_S = R_L / (V_{CC} - V_S) \times V_S$$

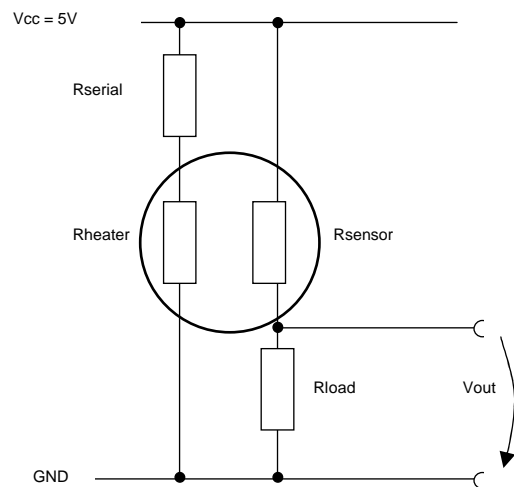

**Fig. 2: Electronic circuit to power the heating resistor and to measure the sensing resistor**

This simple circuit compensates heating power variations caused by changes of  $R_{heater}$  as demonstrated by the graph in Fig. 3. The relative heating power variation is  $\pm 2\%$  for heating resistor values between 60 and 120  $\Omega$ .

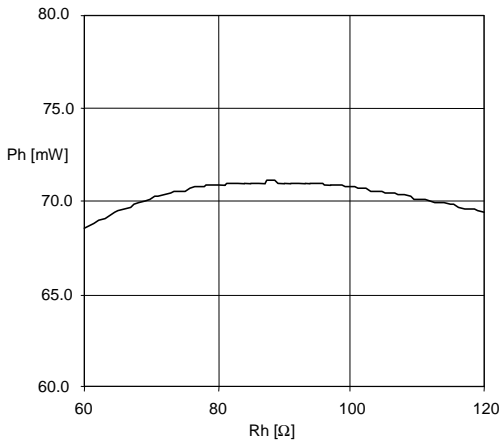

Fig. 3:  $P_h$  as a function of  $R_h$ .  $R_{series} = 88 \Omega$  and  $V_{cc} = 5 V$

### HEATING RESISTOR

The temperature of the sensing layer depends on the heating power and on the ambient temperature. To obtain good sensitivity and fast response times, the sensing layer temperature should stay within a temperature range of 350 °C to 400 °C. Below 350 °C the sensitivity decreases and the sensor response becomes significantly slower. Above 400 °C the sensitivity also decreases and at temperatures above 475 °C the sensor structure can deteriorate due to overheating. Fig. 4 shows the relationship between the applied heating power  $P_h$  and the resulting temperature increase  $\Delta T$  with respect to the ambient temperature.

The heating resistor tends to increase slowly during operating life as shown in Fig. 5. Consequently, the heating power decreases if a constant heater voltage is applied. By using a power compensation circuit as shown in Fig. 2, the power loss can be contained within narrow limits. After 10,000 hours of power-on time,  $R_h$  increases by about 40%. The resulting heating power change is less than 2%.

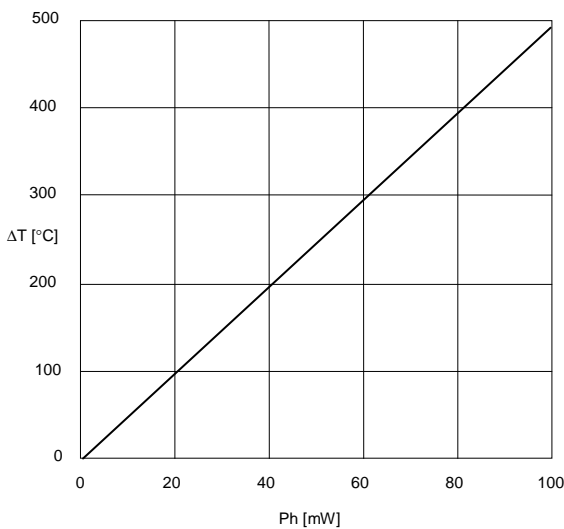

Fig. 4:  $\Delta T$  as a function of  $P_h$

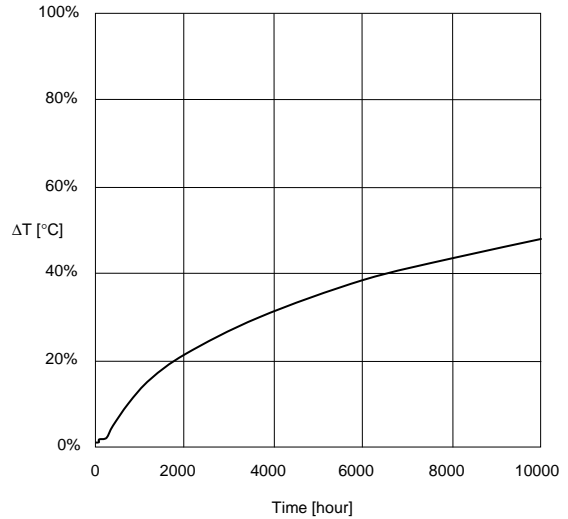

Fig. 5: Relative increase of  $R_h$  as a function of power-on time at ambient temperature

### GAS SENSITIVITY

Fig. 6 shows the sensitivity of the MiCS-2610 to CO, H<sub>2</sub>, CH<sub>4</sub> (HC), and ethanol (VOC). Ozone is an oxidising gas and causes an increase of the sensing resistance, whereas most interfering gases are reducing gases and cause the resistance to decrease.

Temperature and humidity also affect the resistance value of the sensor. Humidity is water (H<sub>2</sub>O) in gas phase, which reacts with the sensing layer like a reducing gas. Increasing humidity produces a decrease of the sensing resistance. As for the temperature, the effect is the same as for the humidity, i.e. decreasing resistance with increasing temperature. This negative temperature coefficient is due to the semiconductor properties of the sensing layer material.

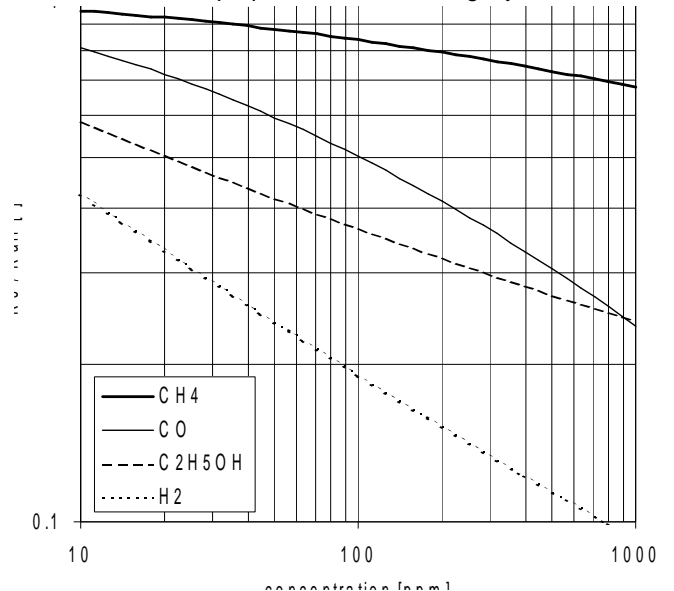
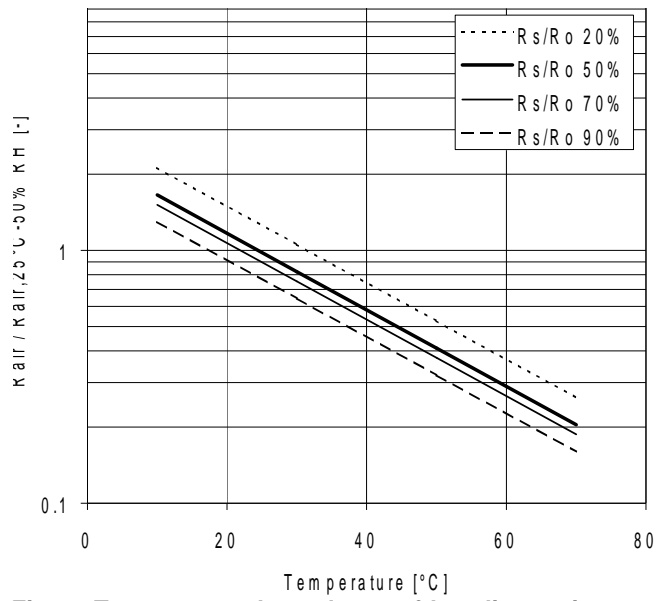

Fig. 6: Sensitivity to CO, H<sub>2</sub>, CH<sub>4</sub>, and C<sub>2</sub>H<sub>5</sub>OH at 25 °C and 50% RH



**Fig. 7: Temperature dependence of baseline resistance  $R_{air}$  for 20%, 50%, 70% and 90% RH**