

Broadband Pulsed Infrared Light Sources

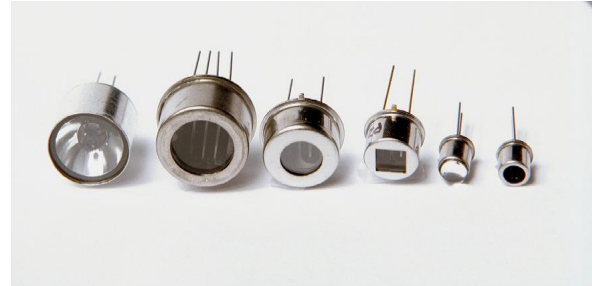



- Broadband IR light from 2-20 μm
- Consistent Pulsed Operation
- Large Temperature Modulation
- Many Package and Window options
- Evaluation Kit for Rapid Prototyping



Steven Sepvest offers a unique class of electrically pulsed, high intensity infrared radiators for gas analysis, spectroscopy, calibration and tactical infrared friend or foe applications. These radiators feature a low thermal-mass filament tailored for high emissivity. The filament is fabricated using a patented process that supplies more IR power output above 4 μm than while operating much cooler. This lower temperature operation reduces the chance of igniting combustible gasses, improves power efficiency, and reduces the parasitic heating of the optics and detectors. These IR sources are typically pulsed at rates from 1/2 to 10 Hz with several hundred degrees of temperature modulation, allowing the design of smaller and simpler systems that do not require the added complexity of a mechanical chopper.

For demonstration and system design, Steven Sepvest provides an Evaluation Kit that includes the light source of your choosing. The Evaluation Kit drive card produces a flat-topped current pulse of adjustable amplitude, length, and frequency that runs with pre-programmed settings, or is connected to a PC for user control via Windows™.

PART NUMBERS/WINDOW OPTIONS:

	Parabola	TO-8	TO-5	TO-46
				
Windowless	reflectIR-P1N	NL8LNC	NL5LNC	NL46LNX
Sapphire 2 to 5.25 μm	reflectIR-P1S	NM8ASC	NM5NSC	N/A
Germanium 7 to 12 μm	N/A	N/A	NL5NGC	N/A
Calcium Flouride 2 to 9.5 μm	reflectIR-P1C	NL8ACC	NL5NCC	N/A

SPECIFICATIONS:





INFRARED LIGHT SOURCES

Parabola

TO-8

TO-5

TO-46

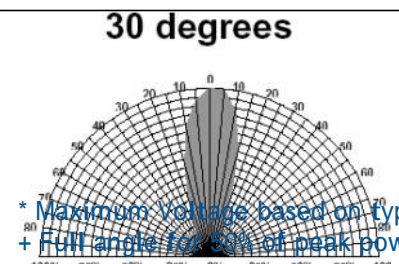
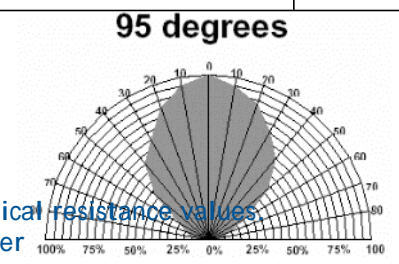
				
Rated Temperature	850 C	850 C	850 C	850 C
Minimum Resistance	1.4 Ohms	2.8 Ohms	2.5 Ohms	0.4 Ohms
Maximum Resistance	2.0 Ohms	4.5 Ohms	3.7 Ohms	1.0 Ohms
Maximum Input Voltage*	1.75 VDC	2.8 VDC	2.6 VDC	0.9 VDC
Output Radiation Pattern+				

* Maximum Voltage based on typical resistance values
 + Full angle for 30% of peak power

PULSED OPERATION

Although capable of running at duty cycles of up to 100 % (DC) most users run the filaments with duty cycles of less than 50%. Square-waveform constant current or constant voltage drive schemes are the simplest and most cost effective means of powering the sources. For constant current drives, the power delivered to the source goes as I²R. As the source heats up, its resistance increases slightly, causing the power delivered to the source to increase during the “ON” portion of a pulse. For constant voltage drives, delivered power goes as V²/R; therefore the power delivered to the source tends to decrease slightly during the length of a pulse. Other drive schemes can also be employed; constant power or DC for example.

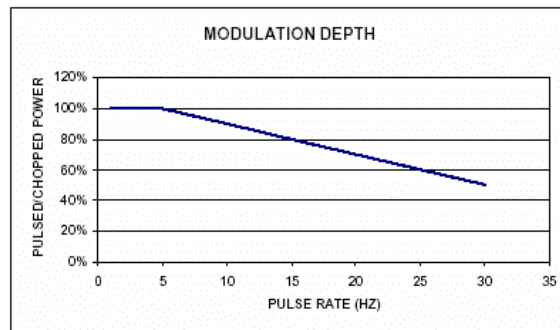

Owing to the extremely low thermal mass of pulsed IR emitters, shot-to-shot stability is directly related to drive circuit stability. Variations in drive pulses will translate into variations in output.

To determine this we used a liquid nitrogen cooled InSb detector available in our laboratory for detecting energy in the 2-5 μm range. The pulsed IR source was driven with a constant-voltage drive circuit that ensures pulse-to-pulse repeatability (standard deviation) of 5.3×10^{-4} . Measurements of the InSb detector reading from 16 seconds of 10 Hz operation was measured to have a comparable standard deviation of 6.8×10^{-4} .

SOURCE LIFETIME

The following graph shows the results (to date) from an ongoing extended life test experiment using an Steven Sepvest NM8ASC source. The source is being driven

by a constant current drive board at 1 Hz, 30% duty cycle at an approximate temperature of 650°C. Two pyroelectric detectors are monitoring the source output at two distinct wavelengths. In the following chart, the circles show the source output at 4.29 microns (CO₂) while the diamonds show the output at 3.9 microns (reference). The detectors are mounted about four inches from the front face of the source and a dry nitrogen purge is used to prevent water vapor and carbon dioxide in the lab air from affecting the measurement. The temperature in the lab is not very well controlled however, and much of the variation (specifically the bump at ≈ 2000 hours) is due to room temperature swings.

The definition of failure, and thus the definition of lifetime, is very subjective as each system has unique sensitivity to drift (largely related to the A/D bandwidth). We have encountered several applications which define failure as >15% drift from the original power level, so we will adopt this definition for the purposes of this computation. The graph below shows that the median signal level from the 3.9 and 4.29 μm detectors is roughly 4 volts; the linear regression fits to the raw data indicate that both of these signals are decreasing at a rate of 1×10^{-5} volts/hour. With our assumed signal drift tolerance of 15% and 4 volt signal level, we require a 0.6 volt signal change to signal failure of the light source [0.15×4]. With our measured rate of change being 1×10^{-5} volts/hour it will take approximately

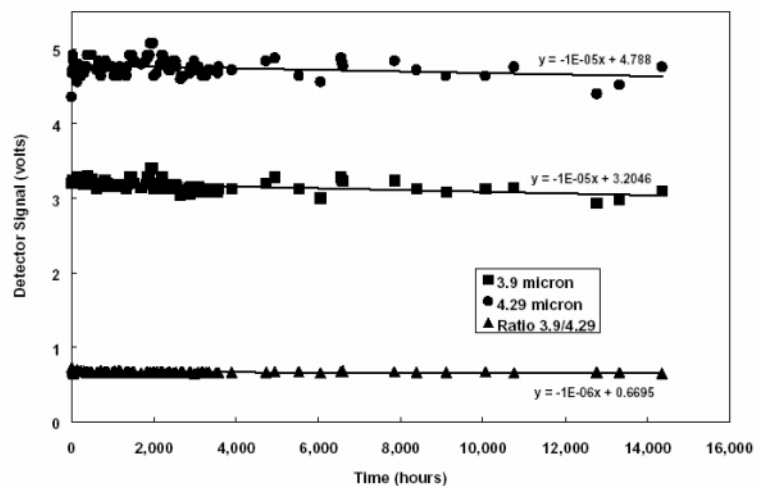

6.85 years of continuous operation to obtain a 15% signal change $[(0.6v)/(1 \times 10^{-5}v/hr)/(8760hrs/yr)]$. Since many systems utilize the ratio of the gas measurement to a reference, they are sensitive not to signal changes, but to change in the ratio of the two signals. With a measured slope of 1×10^{-6} volts/hour and a 0.75 volt signal the same computation yields a lifetime of 12.84 years.

Since all of the known filament degradation mechanisms are temperature dependent, the time to 15% failure is strongly dependent upon operating temperature or electrical power applied. Therefore, caution should be used in extrapolating these results to your application.

REFLECTIR PACKAGE DIMENSIONS

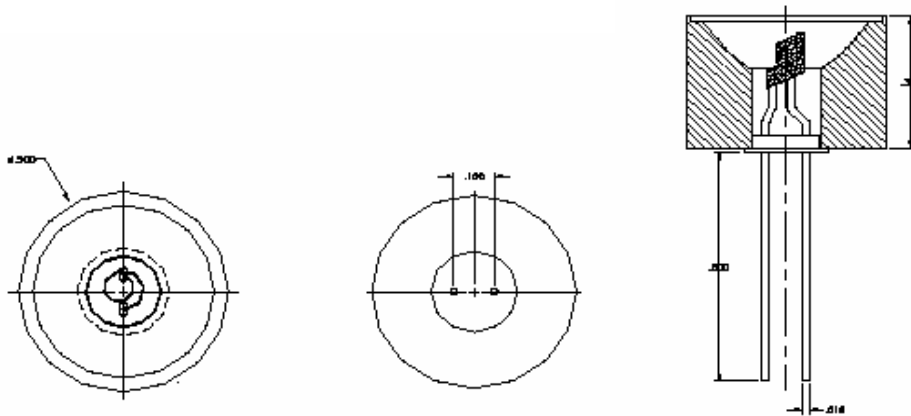

TO-8 PACKAGE DIMENSIONS

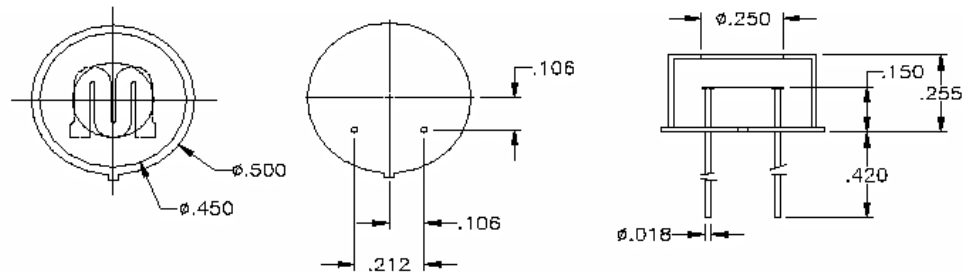

TO-5 PACKAGE DIMENSIONS

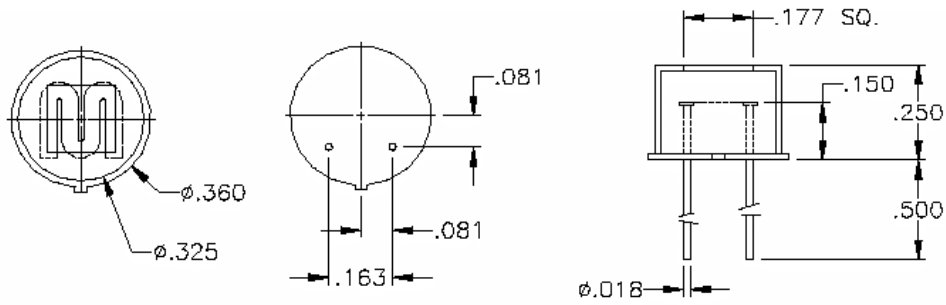

TO-46 PACKAGE DIMENSIONS

