

SOLID STATE RELAY

MAXIMUM LOAD CURRENT 1 A

SJ SERIES

■ FEATURES

- UL, CSA recognized
- Extremely small and light weight
 - Size: 10.0 (W) × 20.2 (L) × 12.8 (H) mm
 - Weight: approximately 5.5g
- High reliability, long life and maintenance free
- High isolation (between input and output)
 - Dielectric strength: 2,500 Vrms
- Compatible with JY Relay in size and terminal arrangement

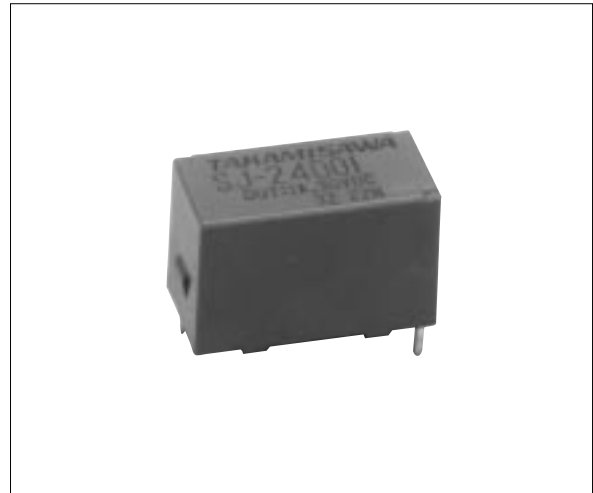

■ ORDERING INFORMATION

[Example] $\frac{SJ}{(a)} - \frac{12}{(b)} \frac{D}{(c)} \frac{01}{(d)} \frac{HZ}{(e)} \frac{R}{(f)} \frac{N}{(g)}$

(a)	Series Name	SJ : SJ Series
(b)	Nominal Voltage (Input side)	3 : 3 VDC (only AC type) 5 : 5 VDC 12 : 12 VDC 24 : 24 VDC
(c)	Load Voltage	A : AC type D : DC type
(d)	Load Current	01 : 1 A
(e)	Kinds of Inverse Connection Protecting Element (only DC type)	Nil : Diode HZ : Zener diode type
(g)	Terminal Classification	Nil : Socket mounting N : PC Board mounting type
(f)	Output Polarity (DC Type)	Nil : Standard Polarity R : Reverse Polarity

■ SAFETY STANDARD AND FILE NUMBERS

UL508 (File No. E45026)

C22.2 No. 0, No.14 (File No. LR35579)

Please request when the approval markings are required on the cover

Type	INPUT Nominal Voltage	OUTPUT Load Voltage
SJ-() A01	5 VDC to 24 VDC	1 A 265 VAC resistive
SJ-() D01	5 VDC to 24 VDC	1 A 30 VDC resistive

■ SPECIFICATIONS

Item		AC	DC	Remarks
		TYPE 1A	TYPE 1A	
INPUT side	Nominal Voltage (DC)	3 V, 5 V, 12 V, 24 V	5 V, 12 V, 24 V	
	Operate Range	±20% of nominal voltage		
	Must Operate Voltage	80% of nominal voltage		
	Must Release Voltage	Minimum 1 V (minimum 0.5 V*)		*3 VDC type
	Input Impedance	3 VDC Type	120Ω ±10%	—
5 VDC Type		360Ω ±10%	430Ω ±10%	
12 VDC Type		1.0 kΩ ±10%	1.2 kΩ ±10%	
24 VDC Type		2.0 kΩ ±10%	2.4 kΩ ±10%	
OUTPUT side	Load Voltage Range	24 to 265 Vrms	3 to 30 VDC	see CHARACTERISTIC DATA
	Maximum Load Current	1.0 Arms	1.0 A	
	Minimum Load Current	10 mArms	1 mA	
	1 Cycle Surge Current	50 A (60 Hz)	3 A (10 ms)	
	Max. Off-state Leakage Current	0.75 mArms (at 100 Vrms 60 Hz) 1.50 mArms (at 200 Vrms 60 Hz)	0.1 mA (at 30 VDC)	
	Max. Off-state Voltage Drop	1.2 Vrms	1.2 V	at max. load current
Max. Operate Time		1 ms		
Max. Release Time		1/2 cycle + 1 ms	1 ms	
Insulation Resistance		Minimum 1,000 MΩ (at 500 VDC)		for input-output
Dielectric Strength		2,500 Vrms for 1 minute		for input-output
Operating Temperature Range		-30°C to + 85°C		
Storage Temperature Range		-40°C to + 100°C		
Case Color		Black	Green	
Weight		Approximately 5.5 g		

■ BLOCK DIAGRAM

LOAD	INSULATION	CIRCUITS	Input/Output waveform (resistive load)
AC	Photo-triac coupler		
DC	Photo-transistor coupler		

■ CHARACTERISTIC DATA

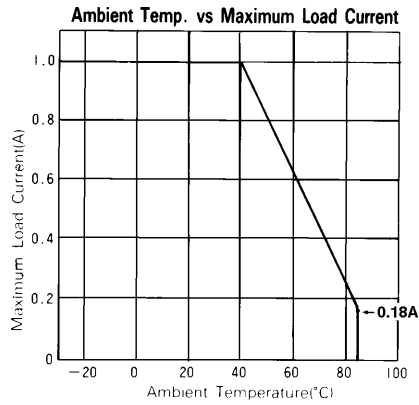

■ REFERENCE DATA

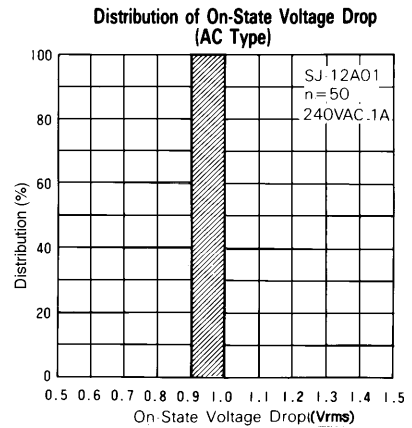
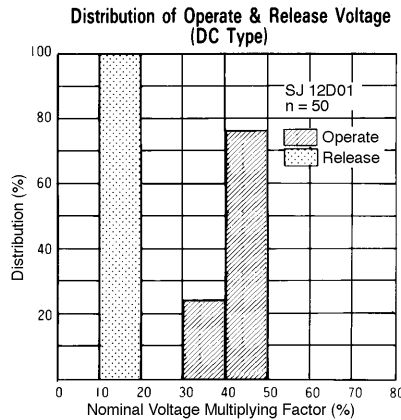
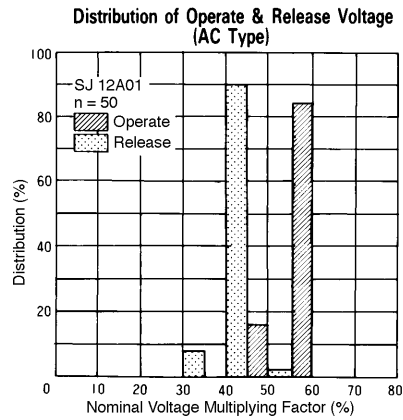

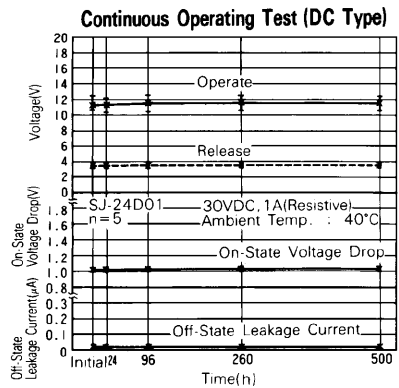
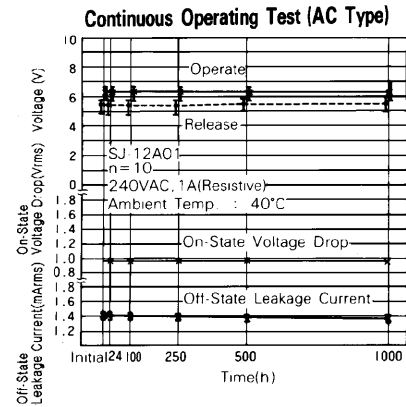
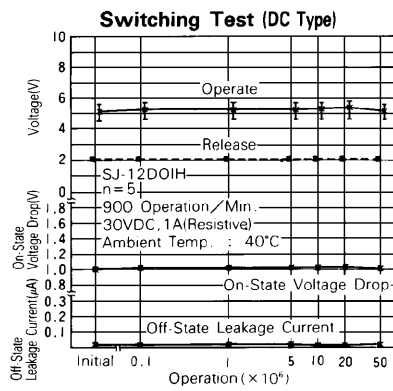
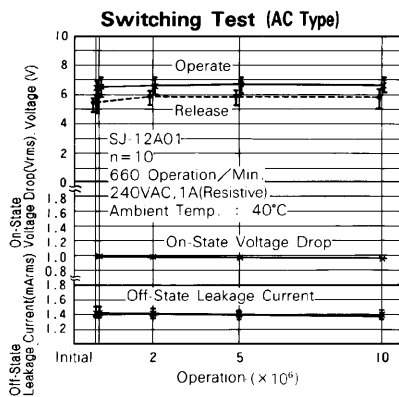
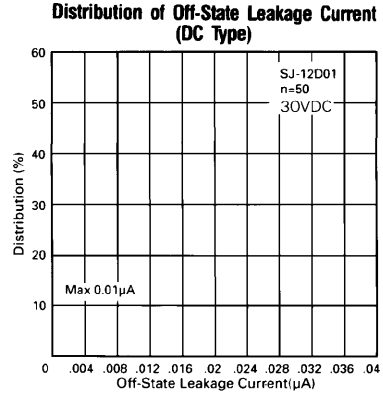
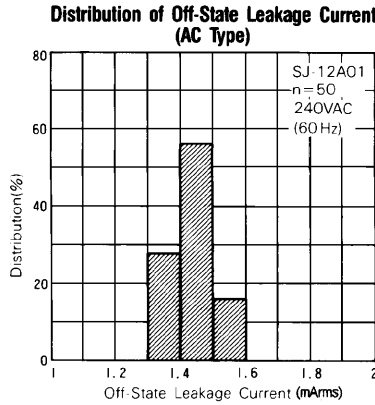
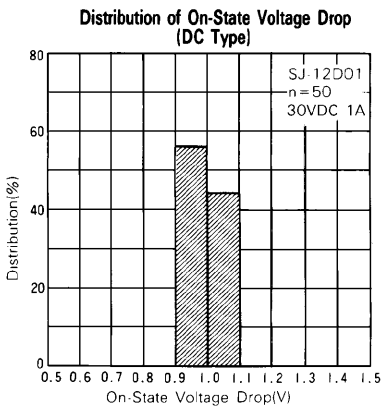

DIMENSIONS

● Dimensions

SJ-()A Type

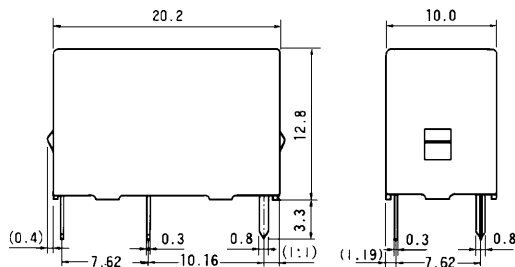

● Schematics (BOTTOM VIEW)

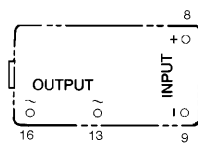

● PC board mounting hole layout (BOTTOM VIEW)

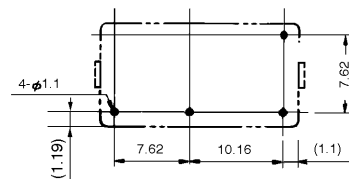

Unit: mm

● **Dimensions**

● **Schematics**
(BOTTOM VIEW)

● **PC board mounting hole layout**
(BOTTOM VIEW)

SJ-()D type

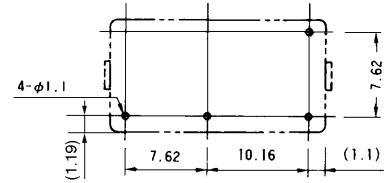
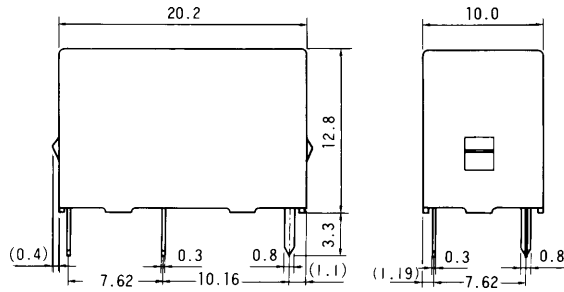

SJ-()AN type

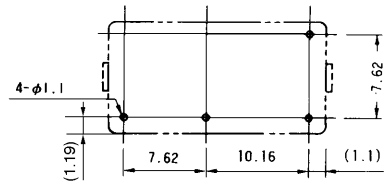
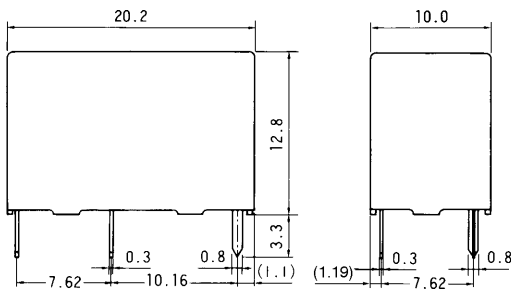

SJ-()DN type

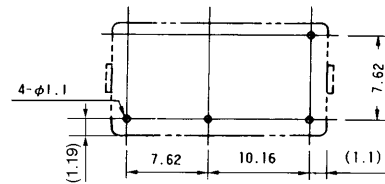
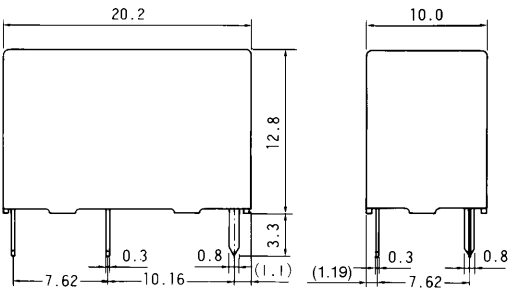

Unit: mm

■ **SOCKET DIMENSIONS**

■ **NOTES**

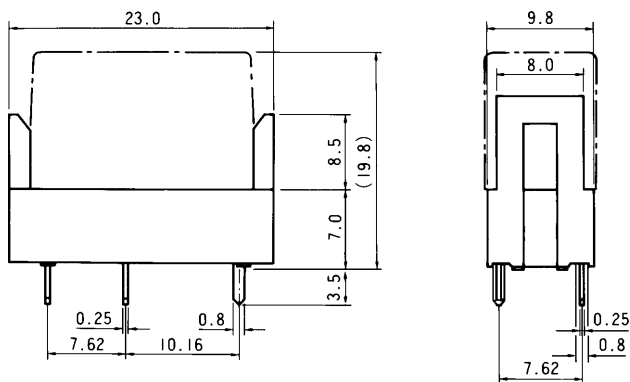

1. Polarity of terminals are pre-determined. Please design your circuit accordingly.
2. Socket ordering code: JK-4N
3. Standard IC socket is not recommended. Please use socket "JK-4N"

Unit: mm

**Fujitsu Takamisawa
International
Headquarter
Offices**

www.fujitsu.takamisawa.com

Japan

Fujitsu Takamisawa Component Limited
Global Marketing and Sales
Gotanda-Chuo Building
3-5, Higashigotanda 2-chome, Shinagawa-ku
Tokyo 141, Japan
Tel: (81-3) 5449-7010
Fax: (81-3) 5449-2626

North and South America

Fujitsu Takamisawa America, Inc.
250 E. Caribbean Drive
Sunnyvale, CA 94089 U.S.A.
Tel: (1-408) 745-4900
Fax: (1-408) 745-4970

Europe

Fujitsu Takamisawa Europe B.V.
Diamantlaan 25
2132 WV Hoofddorp
Netherlands
Tel: (31-23) 5560910
Fax: (31-23) 5560950

Asia Pacific

Fujitsu Takamisawa Asia Pacific Pte. Ltd.
102E Pasir Panjang Road
#04-01 Citilink Warehouse Complex
Singapore 118529
Tel: (65) 375-8560
Fax: (65) 273-3021