

MINIATURE RELAY

2 POLES—1 to 2 A (FOR SIGNAL SWITCHING)

FBR46 SERIES

■ FEATURES

- Miniature size
About 50% smaller in volume compared with the FBR240 series used mainly in communication equipment.
- High surge voltage
2,500 V minimum of surge strength (Bellcore standard), and 1,500 VAC minimum of dielectric strength between coil and contact (-15, -16 type).
- Low power consumption
85 mW of operate power (150 mW of nominal power consumption) by built-in permanent magnet.
- Shipping tube package

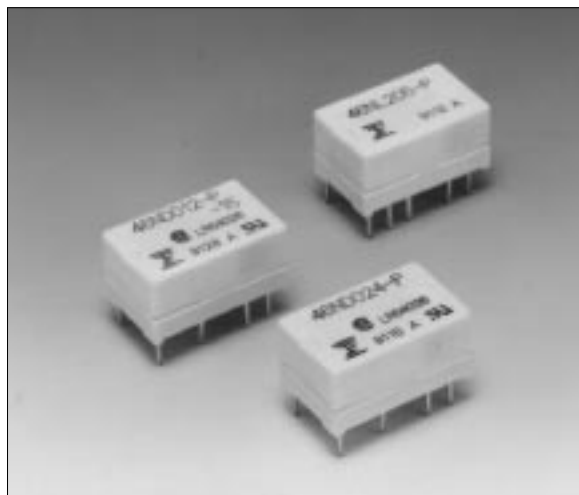

■ ORDERING INFORMATION

[Example] FBR46 N D 012 -P -15 -CSA
 (a) (b) (*) (c) (d) (e) (f)

(a)	Series Name	FBR46: FBR46 Series
(b)	Enclosure	N : Plastic sealed
(*)	Coil Type	D : Standard, -15, -16 (DC coil) G : 65% Operate type L1 : Single winding latching type L2 : Double winding latching type (refer to the SPECIFICATIONS)
(c)	Nominal Voltage	(Example) Standard, -15, -16 type (Example) Latching type 005: 5 VDC 05: 5 VDC 012: 12 VDC 12: 12 VDC (refer to the COIL DATA CHART)
(d)	Contact Material	-P : Gold-overlay silver-palladium
(e)	Dielectric Strength	Nil : Between coil and contacts 1,000 VAC, between contacts 750 VAC -15 : Between coil and contacts 1,500 VAC, between contacts 750 VAC -16 : Between coil and contacts 1,500 VAC, between contacts 1,000 VAC
(f)	Safety Specification	Nil : Standard (UL114 recognized) -CSA : UL114 + CSA recognized

Note: The designation name is stamped on the top of the relay case as follows:
 (Example) Designation ordered: FBR46ND012-P
 Stamp: 46ND012-P

■ SAFETY STANDARD AND FILE NUMBERS

UL114 (File No. E63615)

C22.2 No. 14 (File No. LR40304 or LR64026)

Nominal voltage	Contact rating
1.5 to 24 VDC	1 A 30 VDC resistive 0.5 A 120 VAC resistive

* Excluding latching type FBR46L

■ SPECIFICATIONS

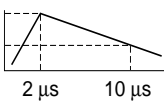
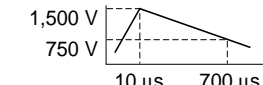
Item		D type, G type	-15 type	-16 type	Latching	
Contact	Arrangement and Style	2 form C (DPDT), bifurcated				
	Material	Gold-overlay silver-palladium				
	Resistance (initial)	Maximum 100 mΩ (at 0.1 A 6 VDC)				
	Ratings (resistive)	0.5 A 120 VAC or 1 A 30 VDC				
	Maximum Carrying Current	1.25 A				
	Maximum Switching Power	60 AV or 30 W				
	Max. Switching Voltage* ¹	125 V				
	Maximum Switching Current	1 A				
	Minimum Switching load* ²	0.01 mA 10 mVDC (reference)				
	Electrostatic Capacity (reference)	Approximately 2 pF (between coil and contacts) Approximately 1 pF (between open contacts)				
Coil	Nominal power (at 20°C)	0.15 to 0.2 W 0.25 W	0.2 to 0.25 W		0.2 W	
	Operate power (at 20°C)	0.085 to 0.112 0.106 W maximum	0.112 to 0.14 W maximum		0.128 W maximum	
	Operating Temperature	-30°C to +70°C (no frost) (refer to the CHARACTERISTIC DATA)				
	Operating Humidity	45 to 85%RH				
Time Value	Operate (at nominal voltage)	Maximum 5 ms				
	Release (at nominal voltage)	Maximum 2 ms				
Insulation	Resistance (initial)	Minimum 1000 MΩ (at 500 VDC)				
	Dielectric Strength (for 1 minute)	between coil and contacts between adjacent contacts	1,000 VAC	1,500 VAC		1,000 VAC
		between open contacts	750 VAC		1,000 VAC	750 VAC
		between set-reset-coil	—			250 VAC
Surge Strength	between coil and contacts between adjacent contacts	1,500 V (at 10 × 700 μs)	2,500 V (at 2 × 10 μs), 250 V		1,500 V (at 10 × 700 μs)	
	between open contacts	1,500 V (at 10 × 700 μs)				

Continued

Item		D type, G type	-15 type	-16 type	Latching
Life	Mechanical	50 × 10 ⁶ operations minimum			
	Electrical (refer to the REFERENCE DATA)	DC	2 × 10 ⁵ operations minimum (at contact rating)		
		AC	1 × 10 ⁵ operations minimum (at contact rating)		
Other	Vibration Resistance		10 to 55 Hz (double amplitude of 1.5 mm)		
	Shock Resistance	Misoperation	500 m/s ² (11 ± ¹ ms)		
		Endurance	1,000 m/s ² (11 ± ¹ ms)		
	Weight		Approximately 2.5 g		

*1 If the switching voltage exceeds the rated contact voltage, reduce the current. The current values vary according to the type of load.

*2 Values when switching a resistive load at normal room temperature and humidity and in a clean environment. The minimum switching load varies with the switching frequency and operation environment.

■ COIL DATA CHART

1. STANDARD (D type)

MODEL	Nominal voltage	Coil resistance (±10%)	Nominal current (at nominal voltage) approx.	Must operate voltage*1	Must release voltage*1	Nominal power	Operate power	Coil temperature rise
FBR46ND003-P	3 VDC	60 Ω	50 mA	75% max. of nominal voltage	5% min. of nominal voltage	Approx. 150 mW (at nominal voltage)	Approx. 85 mW max.	Approx. 25 deg (at nominal voltage)
FBR46ND005-P	5 VDC	167 Ω	30 mA					
FBR46ND006-P	6 VDC	240 Ω	25 mA					
FBR46ND009-P	9 VDC	540 Ω	17 mA					
FBR46ND012-P	12 VDC	960 Ω	13 mA					
FBR46ND024-P	24 VDC	2,880 Ω	8 mA	200 mW	112 mW	30 deg		

*1: Specified values are subject to pulse wave voltage.

Note: All values in the table are measured at 20°C

2. 65% OPERATE TYPE (G type)

MODEL	Nominal voltage	Coil resistance (±10%)	Nominal current (at nominal voltage) approx.	Must operate voltage*1	Must release voltage*1	Nominal power	Operate power	Coil temperature rise
FBR46NG003-P	3 VDC	36 Ω	83 mA	65% max. of nominal voltage	10% min. of nominal voltage	Approx. 250 mW (at nominal voltage)	Approx. 106 mW max.	Approx. 35 deg (at nominal voltage)
FBR46NG005-P	4.5 VDC	81 Ω	56 mA					
FBR46NG006-P	6 VDC	144 Ω	41 mA					
FBR46NG009-P	9 VDC	324 Ω	27 mA					
FBR46NG012-P	12 VDC	576 Ω	20 mA					
FBR46NG024-P	24 VDC	2,304 Ω	10 mA					

*1: Specified values are subject to pulse wave voltage.

Note: All values in the table are measured at 20°C

3. HIGH DIELECTRIC STRENGTH TYPE (-15, -16 type)

MODEL		Nominal voltage	Coil resistance ($\pm 10\%$)	Nominal current (at nominal voltage) approx.	Must operate voltage*1	Must release voltage*1	Nominal power	Operate power	Coil temperature rise
-15 type	-16 type								
FBR46ND003-P-15	FBR46ND003-P-16	3 VDC	45 Ω	67 mA	75% max. of nominal voltage	5% min. of nominal voltage	Approx. 200 mW (at nominal voltage)	Approx. 112 mW max.	Approx. 30 deg (at nominal voltage)
FBR46ND005-P-15	FBR46ND005-P-16	5 VDC	125 Ω	40 mA					
FBR46ND006-P-15	FBR46ND006-P-16	6 VDC	180 Ω	33 mA					
FBR46ND009-P-15	FBR46ND009-P-16	9 VDC	405 Ω	22 mA					
FBR46ND012-P-15	FBR46ND012-P-16	12 VDC	720 Ω	17 mA					
FBR46ND024-P-15	FBR46ND024-P-16	24 VDC	2,304 Ω	10 mA			250 mW	140 mW	35 deg

*1: Specified values are subject to pulse wave voltage.

Note: All values in the table are measured at 20°C.

4. LATCHING TYPE (L1, L2 type)

MODEL		Nominal voltage	Coil resistance ($\pm 10\%$)	Nominal current (at nominal voltage) approx.	Must operate voltage*1	Must release voltage*1	Nominal power	Operate power
Single winding latching type	Double winding latching type							
FBR46NL103-P	FBR46NL203-P	3 VDC	45 Ω	67 mA	80% max. of nominal voltage	80% max. of nominal voltage	Approx. 200 mW (at nominal voltage)	Approx. 128 mW max.
FBR46NL105-P	FBR46NL205-P	5 VDC	125 Ω	40 mA				
FBR46NL106-P	FBR46NL206-P	6 VDC	180 Ω	33 mA				
FBR46NL109-P	FBR46NL209-P	9 VDC	405 Ω	22 mA				
FBR46NL112-P	FBR46NL212-P	12 VDC	720 Ω	17 mA				

*1: Specified values are subject to pulse wave voltage.

Note: All values in the table are measured at 20°C.

CHARACTERISTIC DATA

Range of operation temperature and voltage [D type]

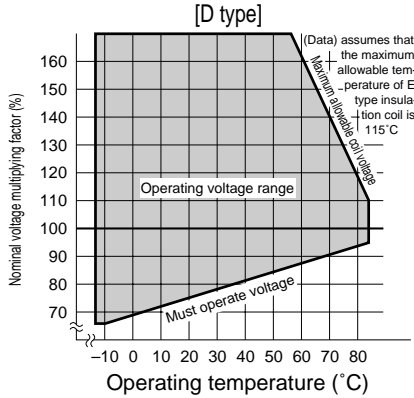

Range of operation temperature and voltage [G type]

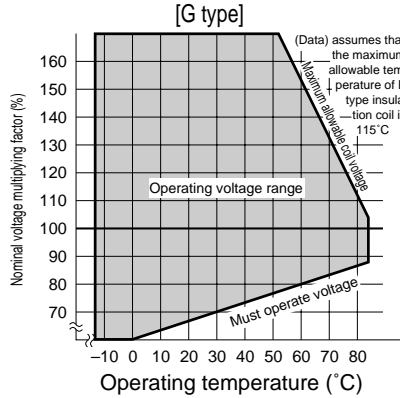

Range of operation temperature and voltage [-15,-16 type]

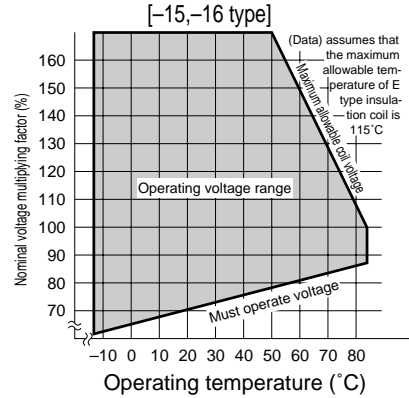

Maximum switching capacity

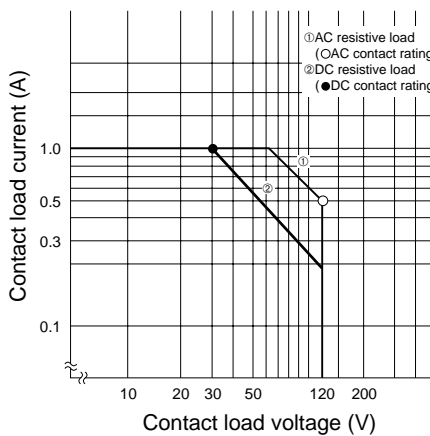

Life curve

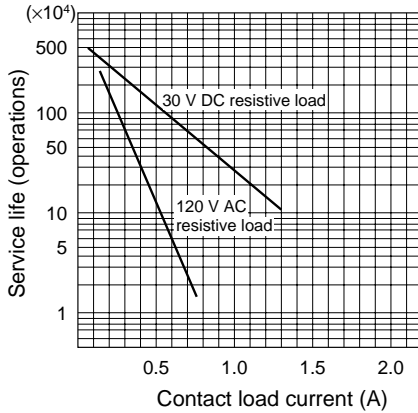

REFERENCE DATA

Distribution of operate and release voltage

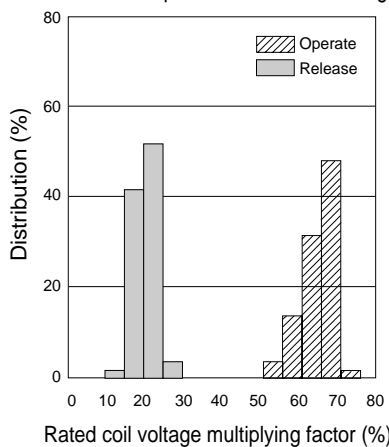

Distribution of operate and release time

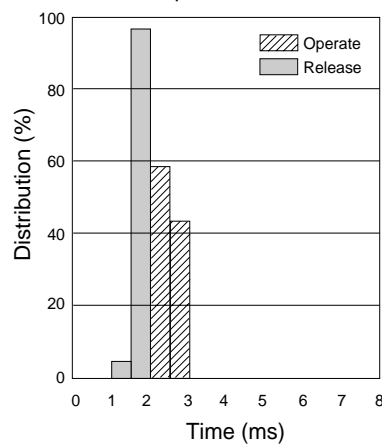

Distribution of contact resistance

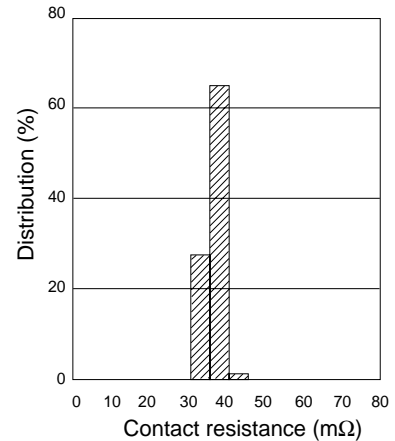

FBR46 SERIES

■ DIMENSIONS

●Dimensions

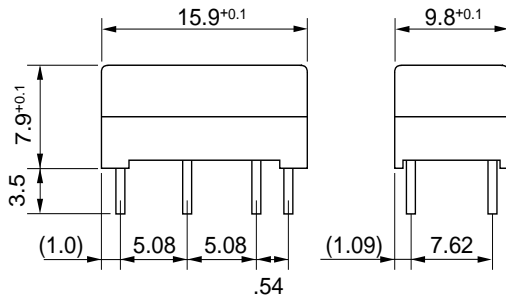

●Schematics (BOTTOM VIEW)

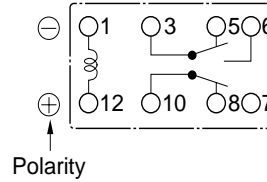

●PC board mounting hole layout (BOTTOM VIEW)

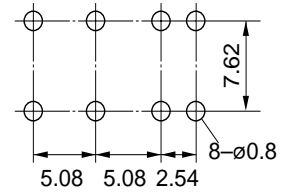

●Tube carrier

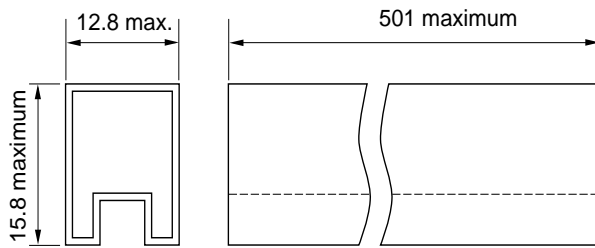

●Dimensions (Latching type)

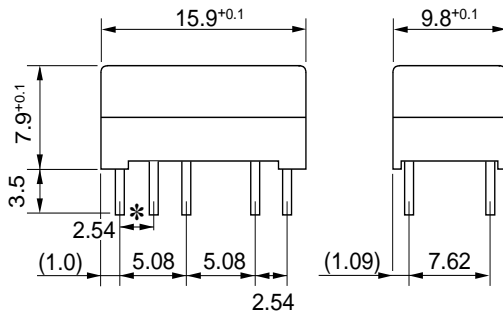

●Schematics (BOTTOM VIEW)

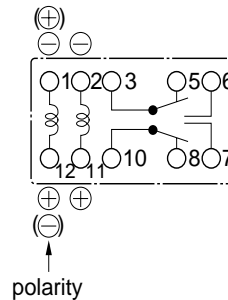

●PC board mounting hole layout (BOTTOM VIEW)

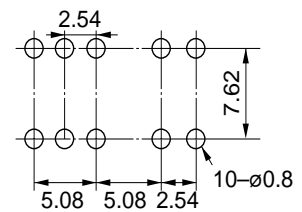

●Tube carrier

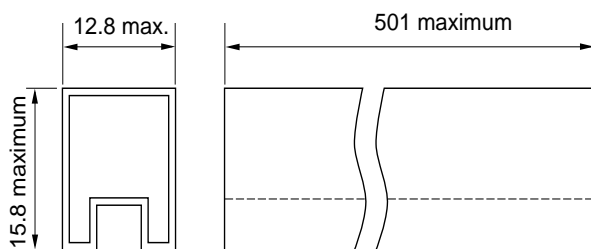

Note: ·No 2, 11 terminals are for double winding latching type only.
 ·(⊕) (⊖) are reset polarity for single winding latching type.
 ·The terminal number is not shown on the relay.

Unit: mm

Fujitsu Takamisawa International Headquarter Offices

www.fujitsu.takamisawa.com

Japan

Fujitsu Takamisawa Component Limited
Global Marketing and Sales
Gotanda-Chuo Building
3-5, Higashigotanda 2-chome, Shinagawa-ku
Tokyo 141, Japan
Tel: (81-3) 5449-7010
Fax: (81-3) 5449-2626

North and South America

Fujitsu Takamisawa America, Inc.
250 E. Caribbean Drive
Sunnyvale, CA 94089 U.S.A.
Tel: (1-408) 745-4900
Fax: (1-408) 745-4970

Europe

Fujitsu Takamisawa Europe B.V.
Diamantlaan 25
2132 WV Hoofddorp
Netherlands
Tel: (31-23) 5560910
Fax: (31-23) 5560950

Asia Pacific

Fujitsu Takamisawa Asia Pacific Pte. Ltd.
102E Pasir Panjang Road
#04-01 Citilink Warehouse Complex
Singapore 118529
Tel: (65) 375-8560
Fax: (65) 273-3021