

# Y214S

## HIGH VOLTAGE, PHOTO MOS RELAY

### COSMO

#### FEATURES

- Normally Open, Single Pole Single Throw
- Control 400VAC or DC Voltage
- Switch 130mA Loads
- LED control Current, 5mA
- Low ON-Resistance
- $dv/dt, >500V/ms$
- Isolation Test Voltage, 1500VACrms

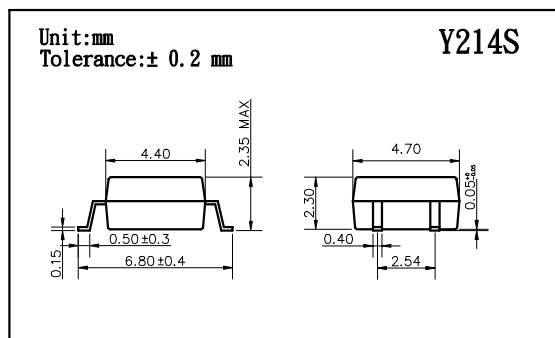

#### Absolute Maximum Ratings(Ta=25°C)

##### Emitter(Input)

Reverse Voltage .....	5.0V
Continuous Forward Current .....	50mA
Peak Forward Current .....	1A
Power Dissipation .....	100mW
Derate Linearly from 25°C .....	1.3mW/°C

##### Detector(Output)

Output Breakdown Voltage .....	± 400V
Continuous Load Current .....	± 130mA
Power Dissipation .....	500mW

##### General Characteristics

Isolation Test Voltage .....	1500VACrms
Isolation Resistance $V_{io}=500V, T_a=25°C$ .....	$\geq 10^{10}\Omega$
Total Power Dissipation .....	550mW
Derate Linearly from 25°C .....	2.5mW/°C
Storage Temperature Range .....	-40°C to +125°C
Operating Temperature Range .....	-30°C to +85°C
Junction Temperature .....	100°C
Soldering Temperature, 2mm from case, 10 sec .....	260°C

• Turn on/Turn off time

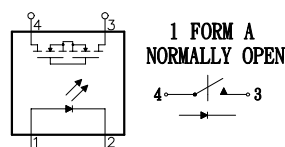
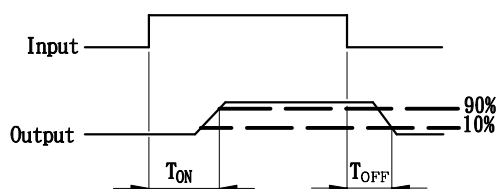

# Y214S

## HIGH VOLTAGE, PHOTO MOS RELAY

### Characterisitcs

(Ta=25°C)

Description	Symbol	Min.	Typ.	Max.	Unit	Test Condition
<b>Emitter(Input)</b>						
Forward Voltage	VF		1.2	1.5	V	IF=10mA
Operation Input Current	IFON			5	mA	VL=± 20V, IL=100mA t=10mS
Recovery Input Current	IFOFF	0.2			mA	VL=± 20V, IL<=5uA
<b>Detector (output)</b>						
Output Breakdown Voltage	VB	400			V	IB=50uA
Output Off-State Leakage	IT(OFF)		0.2	1	uA	VT=100V, IF=0mA
I/O Capacitance	CISO		6		pF	IF=0, f=1MHz
ON Resistance	RON		20	30	Ω	IL=100mA, IF=10mA
Turn-on Time	TON		0.3	1.0	ms	IF=10mA, VL=± 20V
Turn-off Time	TOFF		0.7	1.5	ms	t=10ms, IL=± 100mA

### Mos Relay Schematic and Wiring Diagrams

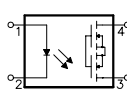
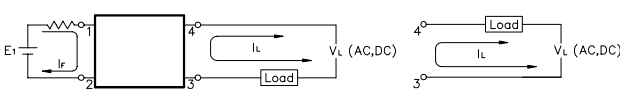
Type	Schematic	Output configuration	Load	Con- nection	Wiring Diagrams
Y214S		1a	AC/DC	A	

### DATA CURVE

Load current vs. ambient temperature  
Allowable ambient temperature:  
-40°C to +85°C

On resistance vs. ambient temperature  
Across terminals 3 and 4 pin  
LED current: 5mA  
Continuouse load current: 130mA(DC)

Trun on time vs. ambient temperature  
Load voltage 400V(DC)  
LED current: 5mA  
Continuouse load current: 130mA(DC)

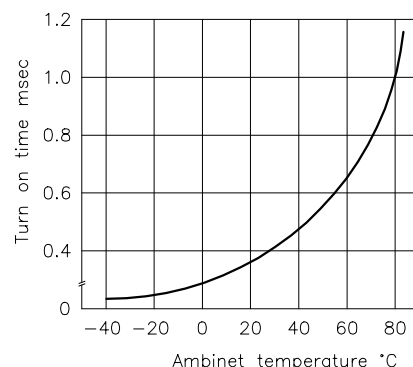
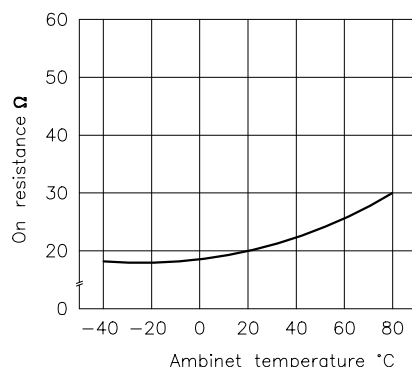
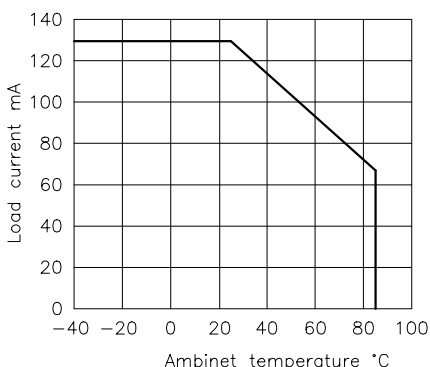

# Y214S

## HIGH VOLTAGE, PHOTO MOS RELAY

### Y214S

Turn off time vs. ambient temperature  
LED current: 5mA; Load voltage: 400V(DC)  
Continuous load current: 130mA(DC)

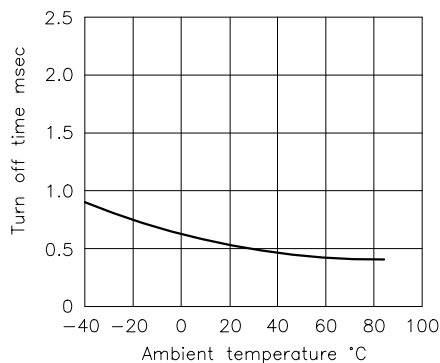

LED operate vs. ambient temperature  
Load voltage: 400V(DC)  
Continuous load current: 130mA(DC)

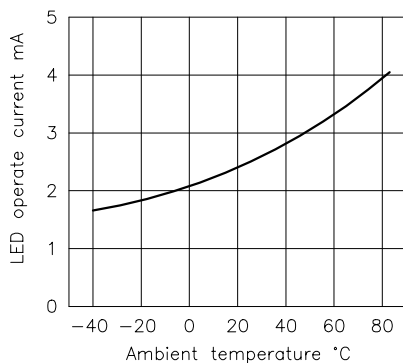

LED turn off current vs. ambient temperature  
Load voltage: 400V(DC)  
Continuous load current: 130mA(DC)

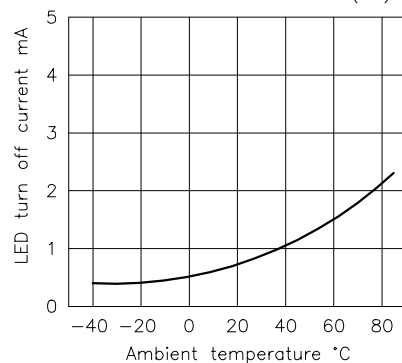

LED dropout voltage vs. ambient temperature  
LED current: 5 to 50mA

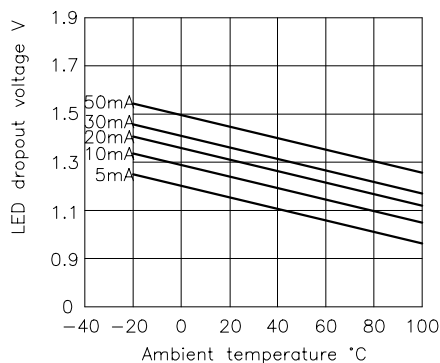

Voltage vs. current characteristics of output at MOS FET portion  
Measured portion: across terminals 3 and 4 pin  
Ambient temperature: 25°C

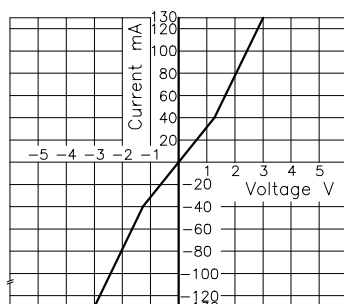

Off state leakage current  
Across terminals 3 and 4 pin  
Ambient temperature: 25°C

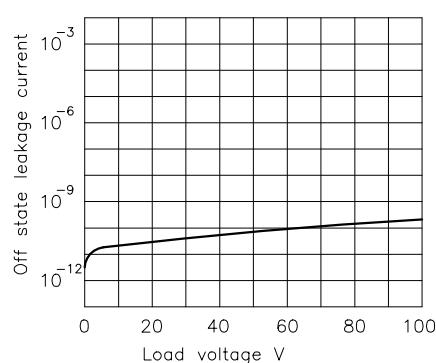

LED forward current vs. turn on time  
Across terminals 3 and 4 pin; Load voltage: 400V(DC); Continuous load current: 130mA(DC); Ambient temperature: 25°C

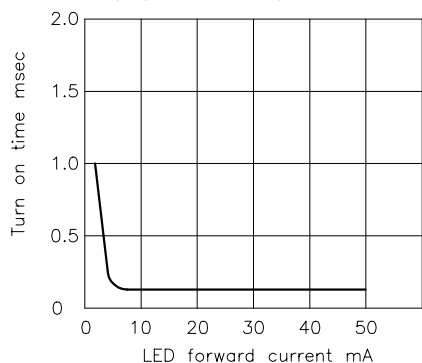

LED forward current vs. turn off time  
Across terminals 3 and 4 pin; Load voltage: 400V(DC); Continuous load current: 130mA(DC); Ambient temperature: 25°C

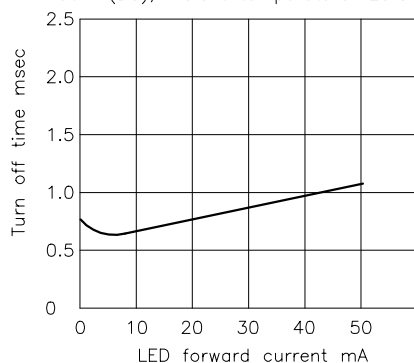

Applied voltage vs. output capacitance  
Across terminals 3 and 4 pin  
Frequency: 1MHz; Ambient temperature: 25°C

