

W614S

HIGH VOLTAGE, PHOTO MOS RELAY

COSMO

FEATURES

- Normally Open and Close, Single Pole Single Throw
- Control 400VAC or DC Voltage
- Switch 130mA Loads
- LED control Current, 5mA
- Low ON-Resistance
- $dv/dt, >500V/ms$
- Isolation Test Voltage, 1500VACrms

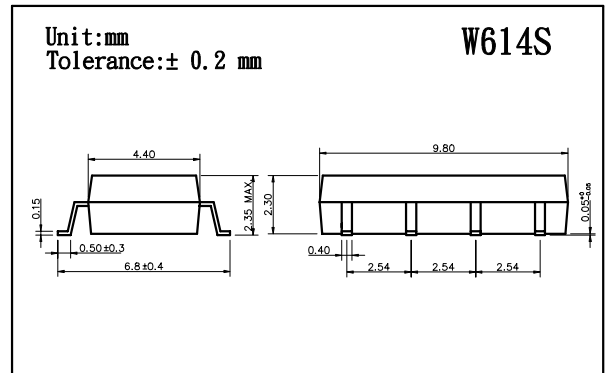

Absolute Maximum Ratings(Ta=25°C)

Emitter(Input)

Reverse Voltage	5.0V
Continuous Forward Current	50mA
Peak Forward Current	1A
Power Dissipation	100mW
Derate Linearly from 25°C	1.3mW/°C

Detector(Output)

Output Breakdown Voltage	± 400V
Continuous Load Current	± 130mA
Power Dissipation	500mW

General Characteristics

Isolation Test Voltage	1500VACrms
Isolation Resistance $V_{io}=500V, T_a=25°C$	$\geq 10^{10} \Omega$
Total Power Dissipation	550mW
Derate Linearly from 25°C	2.5mW/°C
Storage Temperature Range	-40°C to +125°C
Operating Temperature Range	-30°C to +85°C
Junction Temperature	100°C
Soldering Temperature, 2mm from case, 10 sec	260°C

● Turn on/Turn off time Normally Open

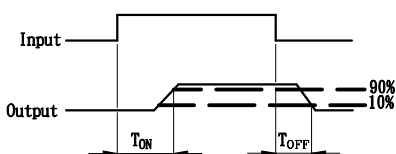

● Operate/Reverse time Normally Close

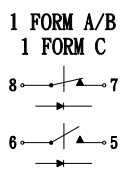
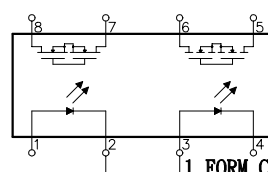
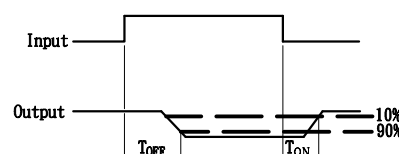

W614S

HIGH VOLTAGE, PHOTO MOS RELAY

Characterisitcs

(Ta=25°C)

Description	Symbol	Min.	Typ.	Max.	Unit	Test Condition
Emitter(Input)						
Forward Voltage	VF		1.8	2.0	V	IF=10mA
Operation Input Current	IFON(N. O) IFOFF(N. C)			5	mA	VL=± 20V, IL=100mA(N. O) VL=± 20V, IL≤5uA(N. C) t=10mS
Recovery Input Current	IFOFF(N. O) IFON(N. C)	0.2			mA	VL=± 20V, IL≤5uA(N. O) VL=± 20V, IL=100mA(N. C) t=10mS

Detector (output) normally open						
Output Breakdown Voltage	VB	400			V	IB=50uA
Output Off-State Leakage	IT(OFF)		0.2	1	uA	VT=100V, IF=0mA
I/O Capacitance	CISO		6		pF	IF=0, f=1MHz
ON Resistance	RON		20	30	Ω	IL=100mA, IF=10mA
Turn-on Time	TON		0.3	1.0	ms	IF=10mA, VL=± 20V
Turn-off Time	TOFF		0.7	1.5	ms	t=10ms, IL=± 100mA

Detector (output) normally close						
Output Breakdown Voltage	VB	400			V	IB=50uA
Output Off-State Leakage	IT(OFF)		0.2	2	uA	VT=100V, IF=10mA
I/O Capacitance	CISO		6		pF	IF=0, f=1MHz
ON Resistance	RON		40	50	Ω	IL=100mA, IF=0mA
Reverse(ON) Time	TON		0.6	1.5	ms	IF=10mA, VL=± 20V
Operate(OFF) Time	TOFF		0.3	1.0	ms	t=10ms, IL=± 100mA

Mos Relay Schematic and Wiring Diagrams					
Type	Schematic	Output configuration	Load	Con- nection	Wiring Diagrams
W614S		1a1b	AC/DC	-	<p>(1)Two independent 1 Form A & 1 Form B use</p> <p>(2)1 Form A 1 Form B use</p>

W614S

HIGH VOLTAGE, PHOTO MOS RELAY

W614S Normally Open Characteristics

DATA CURVE

Load current vs. ambient temperature
Allowable ambient temperature:
-40°C to +85°C

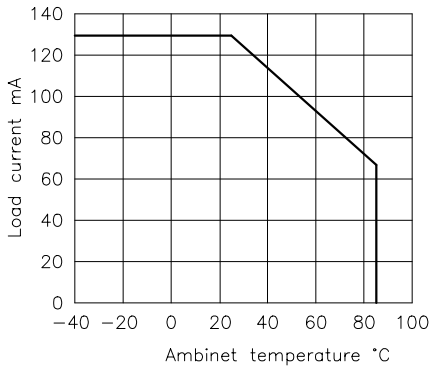

On resistance vs. ambient temperature
Across terminals 5 and 6 pin
LED current: 5mA
Continuous load current: 130mA(DC)

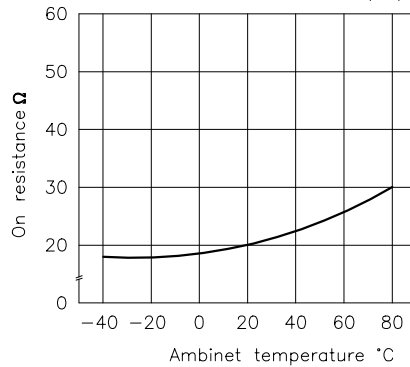

Turn on time vs. ambient temperature
LED current: 5mA; Load voltage: 400V(DC)
Continuous load current: 130mA(DC)

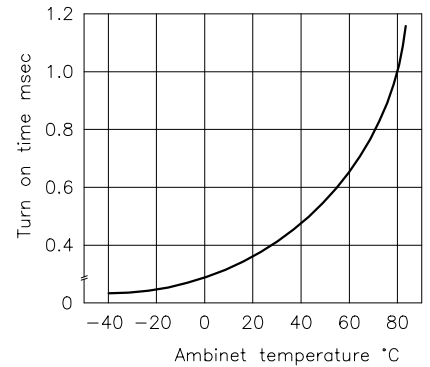

Turn off time vs. ambient temperature
LED current: 5mA; Load voltage: 400V(DC)
Continuous load current: 130mA(DC)

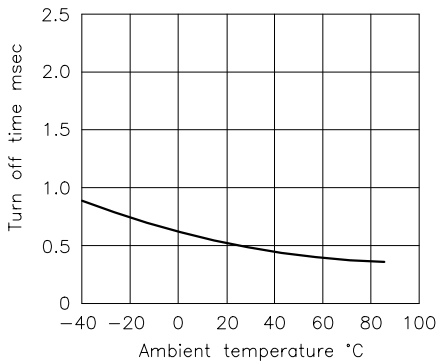

LED operate vs. ambient temperature
Load voltage: 400V(DC)
Continuous load current: 130mA(DC)

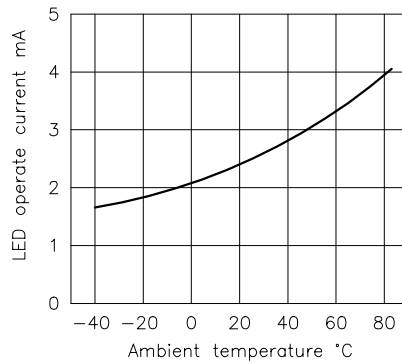

LED turn off current vs. ambient temperature
Load voltage: 400V(DC)
Continuous load current: 130mA(DC)

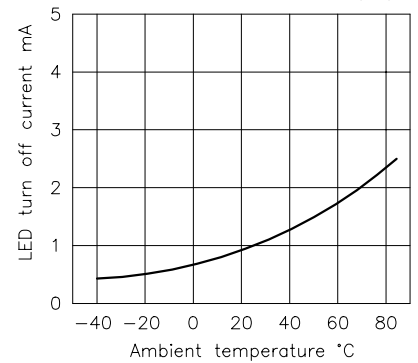

LED dropout voltage vs. ambient temperature
LED current: 5 to 50mA

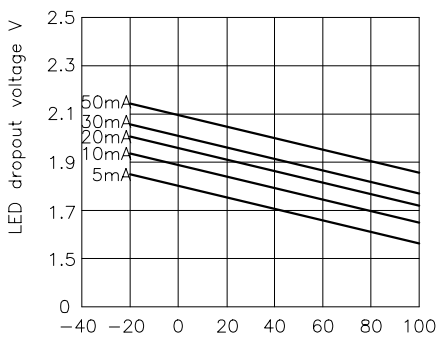

Voltage vs. current characteristics of output at MOS FET portion
Measured portion: across terminals 5 and 6 pin
Ambient temperature: 25°C

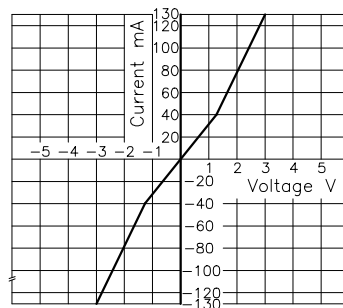

Off state leakage current
Across terminals 5 and 6 pin
Ambient temperature: 25°C

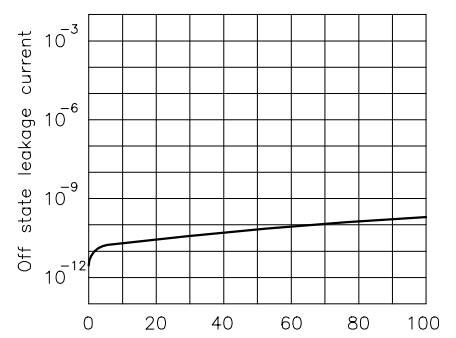

W614S

HIGH VOLTAGE, PHOTO MOS RELAY

W614S Normally Open Characteristics

LED forward current vs. turn on time
Across terminals 5 and 6 pin; Load voltage: 400V(DC); Continuous load current: 130mA(DC); Ambient temperature: 25°C

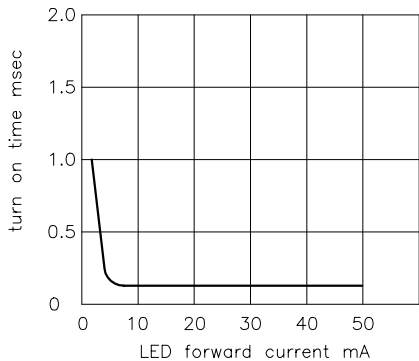

LED forward current vs. turn off time
Across terminals 5 and 6 pin; Load voltage: 400V(DC); Continuous load current: 130mA(DC); Ambient temperature: 25°C

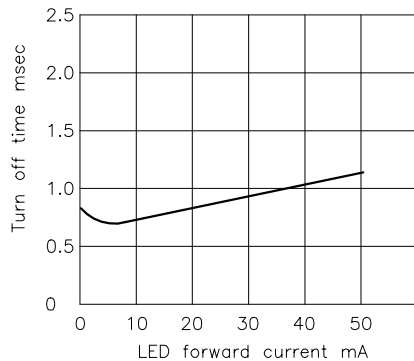

Applied voltage vs. output capacitance
Across terminals 5 and 6 pin
Frequency: 1MHz; Ambient temperature: 25°C

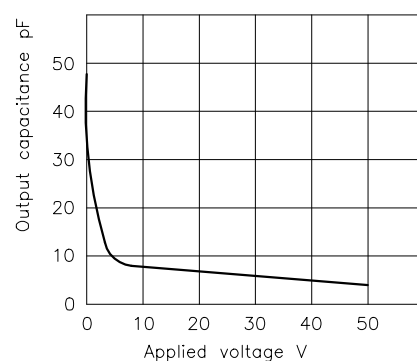

W614S Normally Close Characteristics

DATA CURVE

Load current vs. ambient temperature
Allowable ambient temperature:
-40°C to +85°C

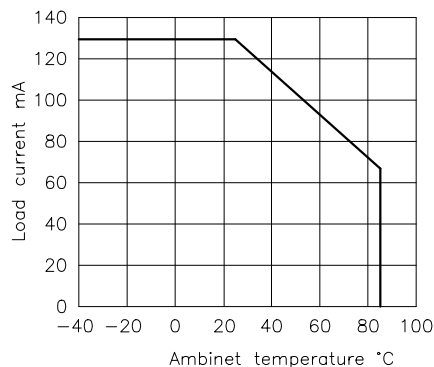

On resistance vs. ambient temperature
Across terminals 7 and 8 pin
LED current: 0mA
Continuous load current: 130mA(DC)

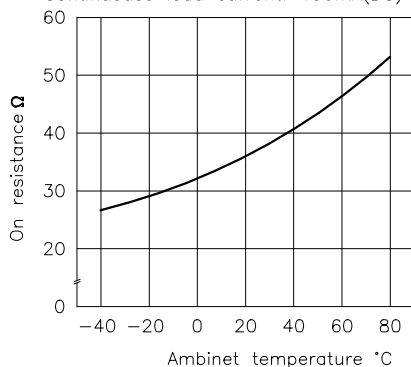

Operate(OFF) time vs. ambient temperature
LED current: 5mA; Load voltage
400V(DC) Continuous load current:
130mA(DC)

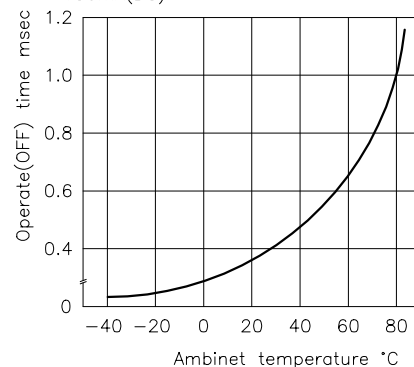

Reverse(ON) time vs. ambient temperature
LED current: 5mA; Load voltage: 400V(DC)
Continuous load current: 130mA(DC)

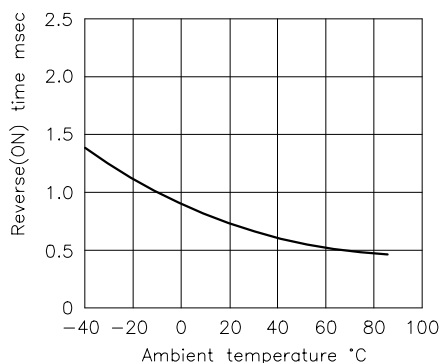

LED operate(OFF) vs. ambient temperature
Load voltage: 400V(DC)
Continuous load current: 130mA(DC)

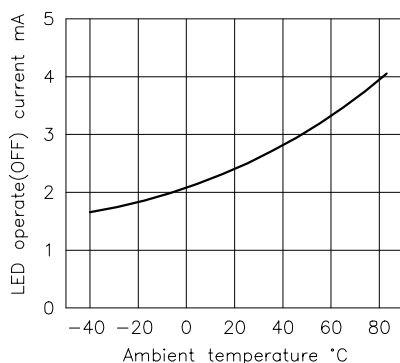

LED reverse(ON) current vs. ambient temperature
Load voltage: 400V(DC)
Continuous load current: 130mA(DC)

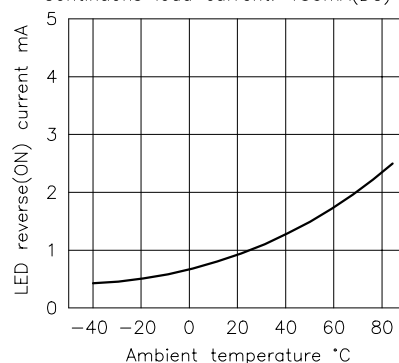

W614S

HIGH VOLTAGE, PHOTO MOS RELAY

W614S Normally Close Characteristics

LED dropout voltage vs. ambient temperature
LED current: 5 to 50mA

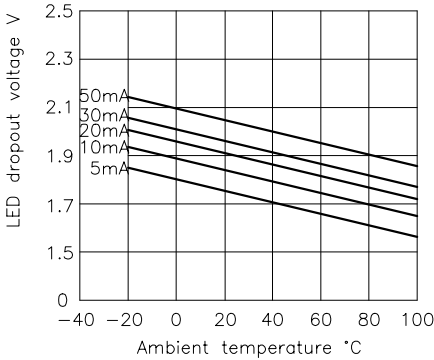

Voltage vs. current characteristics of output at MOS FET portion
Measured portion: across terminals 7 and 8 pin
Ambient temperature: 25°C

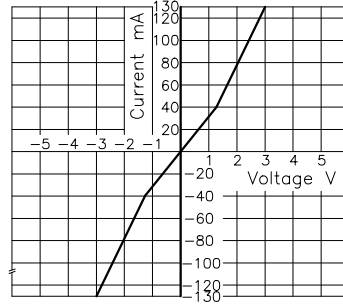

Off state leakage current
Across terminals 7 and 8 pin
Ambient temperature: 25°C

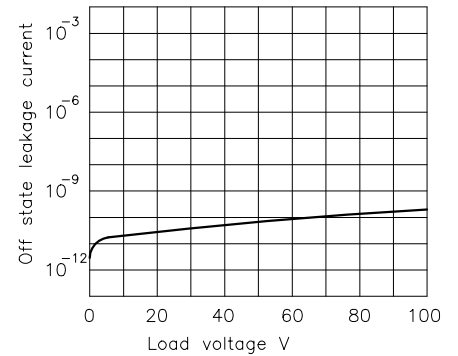

LED forward current vs. operate(OFF) time
Across terminals 7 and 8 pin; Load voltage: 400V(DC); Continuous load current: 130mA(DC); Ambient temperature: 25°C

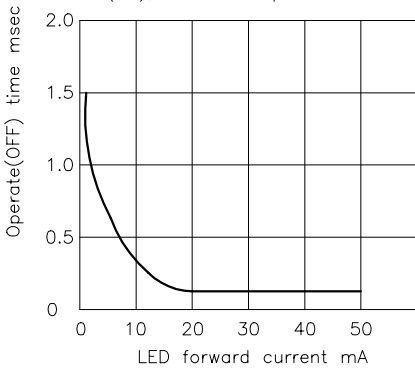

LED forward current vs. reverse(ON) time
Across terminals 7 and 8 pin; Load voltage: 400V(DC); Continuous load current: 130mA(DC); Ambient temperature: 25°C

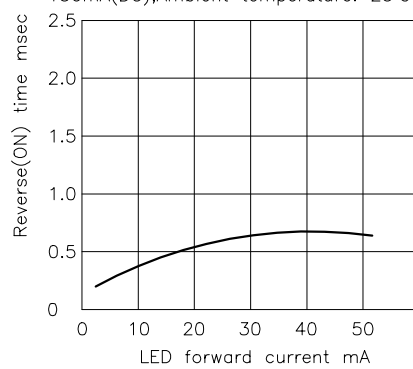

Applied voltage vs. output capacitance
Across terminals 7 and 8 pin
Frequency: 1MHz; Ambient temperature: 25°C

