 <p>NEMOTO</p>	<p><b>Nemoto &amp; Co Ltd Sensor Division</b></p>	<p>Nemoto (Europe) B.V. Burgemeester Haspelslaan 53 1181NB, Amstelveen The Netherlands Tel +31 20 670 3858 Fax +31 20 670 2709 <a href="http://www.nemoto.eu">www.nemoto.eu</a></p>
---	---	---

## Operating Characteristics and Handling Manual for the NAP-505 Carbon Monoxide Gas Sensor

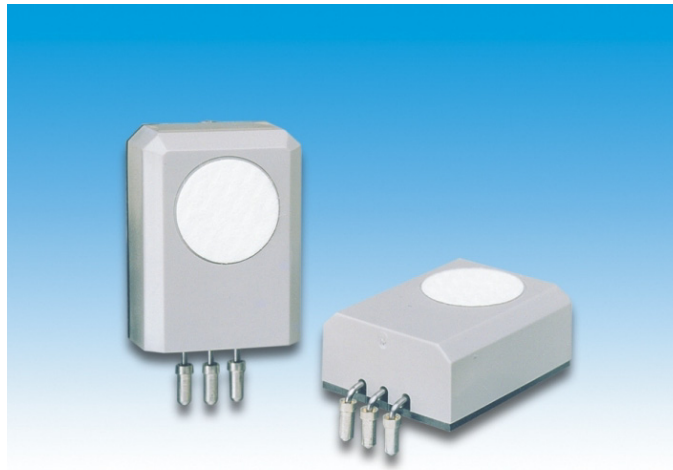

Nemoto has a policy of continuous development and improvement of its products. As such the specification for the device outlined in this document may be changed without notice.



## Contents

<b>Electrochemical Carbon Monoxide Gas Sensors – General.....</b>	<b>3</b>
Principles of Operation	3
Comparison with Other Technologies	4
<b>Features and Specifications.....</b>	<b>5</b>
Features	5
Specifications	6
Dimensions, Drawing	7
<b>Performance Measurements.....</b>	<b>8</b>
Gas Sensitivity	8
Cross-Sensitivity to Other Gases	8
Response Time Characteristics	9
Response Times at Different Temperatures	9
Pressure Dependence and Altitude	10
Initial Start-up time	11
Temperature Dependence	12
Wind and Flow-Rate Influences	13
Long Term Stability	14
<b>Tolerance to Environmental Extremes.....</b>	<b>16</b>
Storage in Extreme Temperature and Humidity	16
Transient Temperature Changes (Heat Shock)	18
Tolerance to Over-Range Levels of CO	19
Tolerance to Corrosive Gases	20
Tolerance to Solvents	21
Tolerance to Silicones	22
Vibration	22
Physical Shocks	23
<b>Characteristics Relating to Specific Standards.....</b>	<b>24</b>
UL2075 Stability Test	24
EN50291 Over-Range Exposure Test	25
<b>Basic Recommended Measuring Circuits.....</b>	<b>26</b>
Basic Recommended Circuit	26
Low Power Circuitry	26
Battery Operation	27
Lists of suitable Operational Amplifiers	28
<b>Notes on Instrument Design and Handling Considerations.....</b>	<b>29</b>
Long Term Stability Considerations	29
Seasonal Variations	29
Storage Conditions	29
Connection and Positioning on a PCB	29
Soldering	29
Other Handling Considerations	29



## Principles of Operation

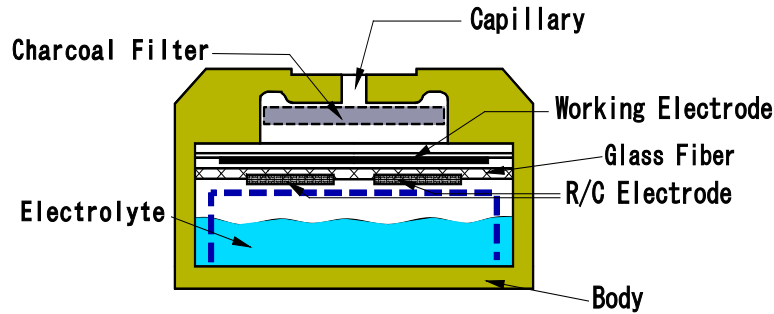

The NAP-505 consists of 3 porous noble metal electrodes separated by an acidic aqueous electrolyte, housed within a plastic (PPO) enclosure. Gas enters the cell via a gas phase diffusion barrier (capillary) and a charcoal based filter that removes unwanted gases which might interfere with the sensors performance or give a false signal. An electrolyte reservoir ensures an excess of electrolyte is available at all times, and the sensor is vented to ensure that the internal and external pressure of the sensor is in equilibrium.

In operation, gas enters the cell via the capillary and filter, and comes into contact with the 'working' electrode. Any carbon monoxide present undergoes the following (oxidation) reaction:

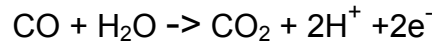

The  $\text{CO}_2$  generated vents away from the cell via the capillary, whilst the hydrogen ions ( $\text{H}^+$ ) migrate into the electrolyte within the cell. The electrons ( $\text{e}^-$ ) generated at the working electrode are collected by the external circuit via a metal strip in contact with it, in the form of a small (nA) electric current.

The reaction at the working electrode is balanced by a reciprocal (reduction) reaction at the 'counter' electrode, using Oxygen from the surrounding atmosphere.

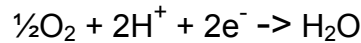

The electrons consumed in this reaction are supplied by the external circuit via a metal strip in contact with the counter electrode.

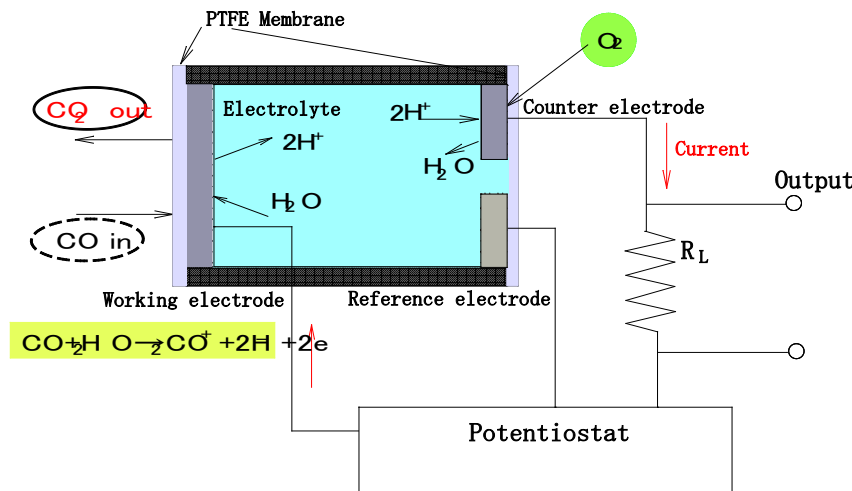



Thus water is consumed whilst Hydrogen ions are generated at the working electrode, whilst the water is re-created and hydrogen ions are consumed at the counter electrode. At the same time, the reaction at the working electrode generates electrons, whilst the reaction at the counter electrode consumes electrons. By connecting the working and counter electrodes together via a special circuit, flow of electrons between the two electrodes is measured as a nA level current signal proportional to the carbon monoxide concentration.

The 'reference' electrode maintains the healthy operation of the cell. It is surrounded by electrolyte, sees no gas and no current is allowed to be drawn from it. Its electrochemical potential hence always remains constant at a level known as the "rest air potential" and this is used to regulate the potential of the working electrode, regardless of the current it is generating during operation. The use of a reference electrode in this way (i.e. three-electrode operation) helps to extend the working range of the sensor, improves linearity and results in a number of performance benefits compared with similar sensors working with 2-electrodes only.

## Comparison of Electrochemical Sensors with other sensor types

Electrochemical gas sensors have the following superiority to conventional semiconductor type and biomemetic type gas sensors.

- ❖ Linear output in proportion to gas concentration
- ❖ High reproducibility
- ❖ Highly gas specific
- ❖ Unaffected by humidity
- ❖ Stable output for long periods
- ❖ Low power consumption because no heater is used (can be battery operated)
- ❖ Small and lightweight (can be used in portable devices)
- ❖ Highly resistant to shocks and vibrations.

Detection Principle	Electrochemical type	Semi-conductive type	Biomemetic type
Criteria			
Linearity	Linear	Logarithmic	Non-Linear
Response and Recovery Time	Fast	Very Fast	Very Slow
Selectivity	Excellent	Poor	Good
Humidity dependence	No influence	Large Influence	Very Sensitive (Frequent cause of false alarms)
Mechanical Durability	Excellent	Poor (internal components prone to breakage)	Excellent
Power consumption	Self Powering.	High Power Consumption 15 - 150mW typical depending on mode of operation	Fairly Low Power required by LED



## Features and Specifications of the NAP-505

### Features

NAP-505 has been developed from our accumulation of technologies in production of hot-wire type gas sensors, long research experience into catalysts, fine printing, and assembling of sensors. The NAP-505 is small and less-expensive, but has high sensitivity, long life, and leak-free performance even under severe operating conditions.

**Small-size:** The NAP 505 is one of the smallest electrochemical sensors in the world to accommodate the design and manufacture of smaller gas detection products and allowing space for additional features.

**Air vent:** The electrolyte used for chemical sensors is hygroscopic, i.e. it has affinity for water, and its volume varies depending on ambient temperature and humidity. This variation causes pressure inside the sensor to rise and fall. In the worst case the electrolyte may leak out of the sensor and damage the circuitry around it.

To prevent this, the NAP-505 combines small size with an air vent capability. This maintains equilibrium between internal and external pressures and allows the sensor to be used in any orientation and under high temperature and humidity conditions.

**Solderable:** Conventional electrochemical sensors cannot be soldered directly to pins because the rapid temperature increase causes thermal deformation of the plastic housing and subsequent leakage of electrolyte. The NAP-505 uses a unique electrode pin and socket design to dissipate heat and minimize the affect of high temperature. This simplifies the assembling process as the NAP-505 can be soldered directly to a PCB (see notes on page 29).

**Excellent Tolerance of high CO concentrations:** The NAP-505 has been developed using the same electrode technology used for Nemoto's Industrial range of CO sensors. This results in the ability of the NAP-505 to retain its linearity and measurement performance even at concentrations up to 1% Carbon monoxide, for short periods, and no damage will result from short exposures to high concentrations. The linearity plot below illustrates this:

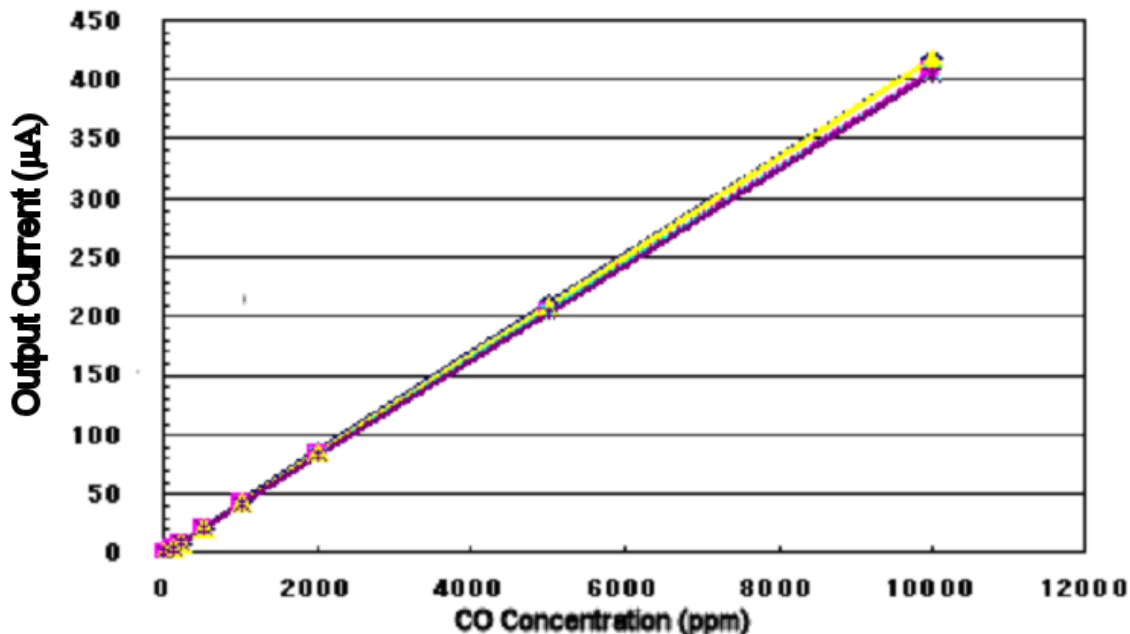



## General Specifications:

<b>Operating Specifications:</b>	
<b>Detected Gas</b>	Carbon Monoxide
<b>Standard concentration range</b>	0 - 1000ppm
<b>Output Sensitivity</b>	40nA ± 10nA/ppm
<b>Zero Offset at 20°C</b>	0 to 5ppm equivalent
<b>Response Time (Measured as T90T)</b>	<30 secs
<b>Accuracy (Measured as Repeatability)</b>	± 2%of Signal
<b>Temperature Dependence (Zero)</b>	± 10ppm between -20°C and +50°C
<b>Long Term Sensitivity Drift</b>	Less than 5% per year
<b>Expected Lifetime in the field</b>	7 Years. (In an appropriate Residential or Light commercial application)
<b>Environmental Specifications:</b>	
<b>Temperature Range</b>	-20 to +50 degree C
<b>Standard constant Humidity Range</b>	15 to 90%RH
<b>Standard Constant Pressure Range</b>	1atm ± 10%
<b>Recommended storage Temperature Range</b>	0 to 20 degree C
<b>Recommended Maximum Storage Time</b>	6 months
<b>Mechanical Data</b>	
<b>Enclosure Material</b>	PPO
<b>Enclosure Colour</b>	Grey
<b>Weight</b>	2.6g
<b>Total Volume</b>	2.4cm <sup>3</sup>
<b>Conformity to International Standards</b>	
<b>UL2075 Approval Details:</b>	Approved as a component. File No.E2406971, Nov 2004
<b>Test Conducted and Approved:</b>	Normal Operation (UL 2075) Sensitivity UL 2075 / with UL 2034 CO Sensitivity Limits Overload (UL 2075) Circuit Measurements (UL 2075) 15ppm CO for 1year Operation (UL 2075) Selectivity
<b>EN 50291</b>	No Component certification is possible for this standard, but detectors fitted with the NAP-505 have been approved.
<b>JIA (Japan)</b>	Conformity to the standard for use as a commercial incomplete combustion alarm.  Conformity to the standard for use within a battery operated incomplete combustion alarm



## Dimensions

### Direct Soldering Models

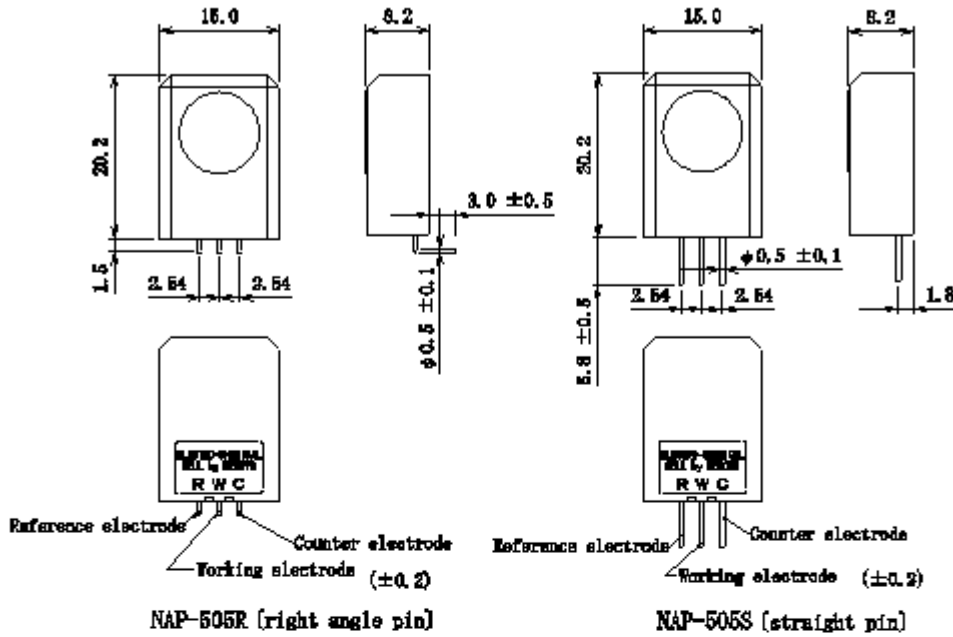

### Socket Models

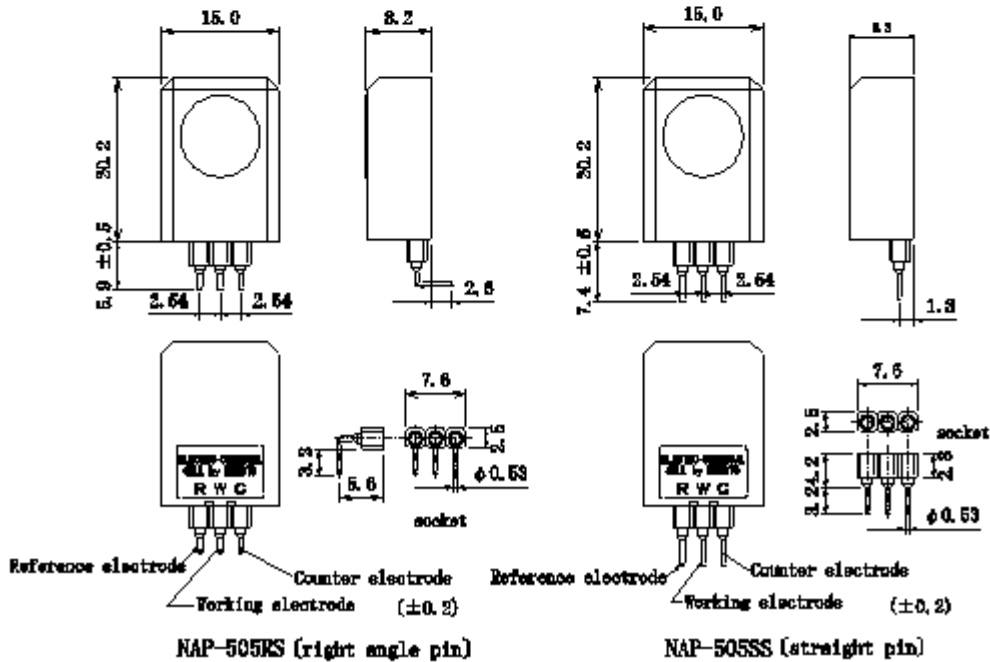



## Performance Measurements

### Gas sensitivity

The Graph below shows the sensitivity characteristics for various gases:

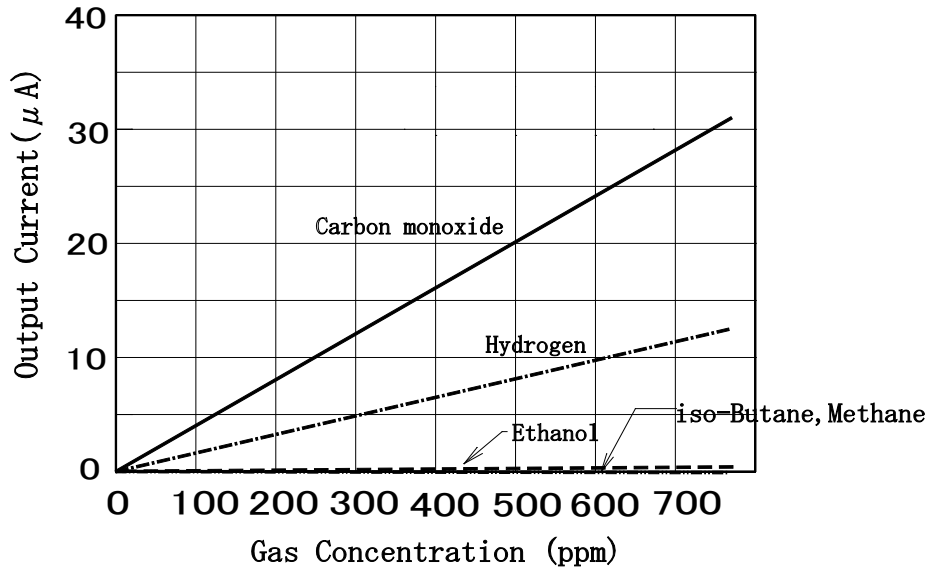

### Cross Sensitivities to other Gases:

Test gas	Gas Concentration Tested (ppm)	Typical carbon-monoxide reading (ppm) Equivalent
Carbon monoxide	100	100
Hydrogen	500	200
Methane	5000	0
Iso-butane	2500	0
Carbon dioxide	5000	0
Sulfur dioxide	25	0
Hydrogen sulfide	10	0
Nitrogen monoxide	30	<10
Nitrogen dioxide	30	0
Ammonia	100	0
Ethyl acetate	200	0
Heptane	500	0
Ethanol	2000	< 30 (30 min Exposure)
HMDS (Silicone)	10	0 (40 min exposure)





## Response Characteristics

The Figure below shows the typical response and recovery characteristics to CO gas on NAP-505.

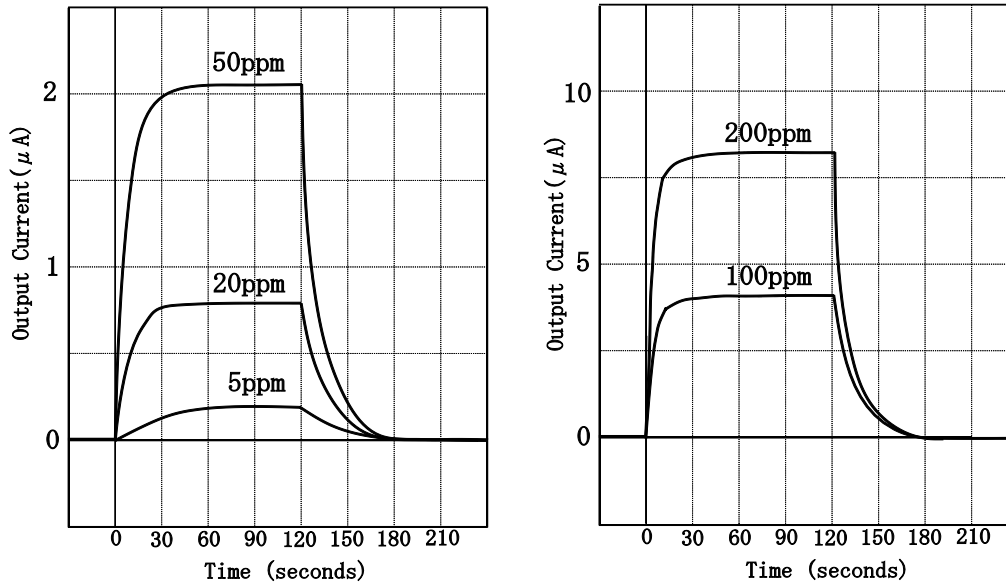

## Response Time at Different Temperatures

The Table below shows the effect of Temperature on Response Time. The Gas used was 200ppm CO / air.

Response	Response time (s)				
	-20 °C	-10 °C	0 °C	20 °C	40 °C
<b>T 60</b>	6	Less than 5	Less than 5	Less than 5	Less than 5
<b>T 90</b>	52	30	18	12	9
<b>T 95</b>	112	60	36	21	12



## Pressure Dependence and Altitude

The figure below illustrates the typical pressure dependence of the NAP-505:

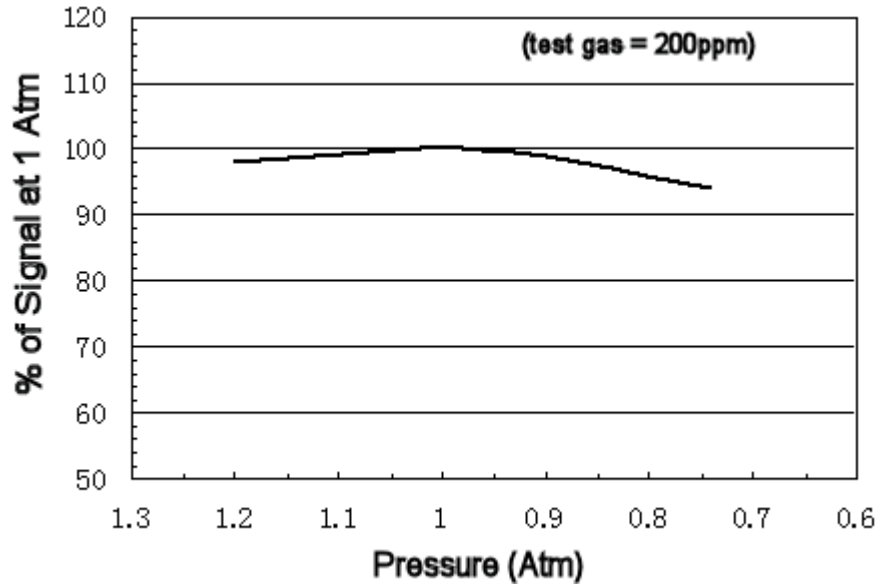

The Figure below represents the effect of altitude on the sensitivity of the NAP-505:

Effect of Altitude on Sensitivity, NAP-505

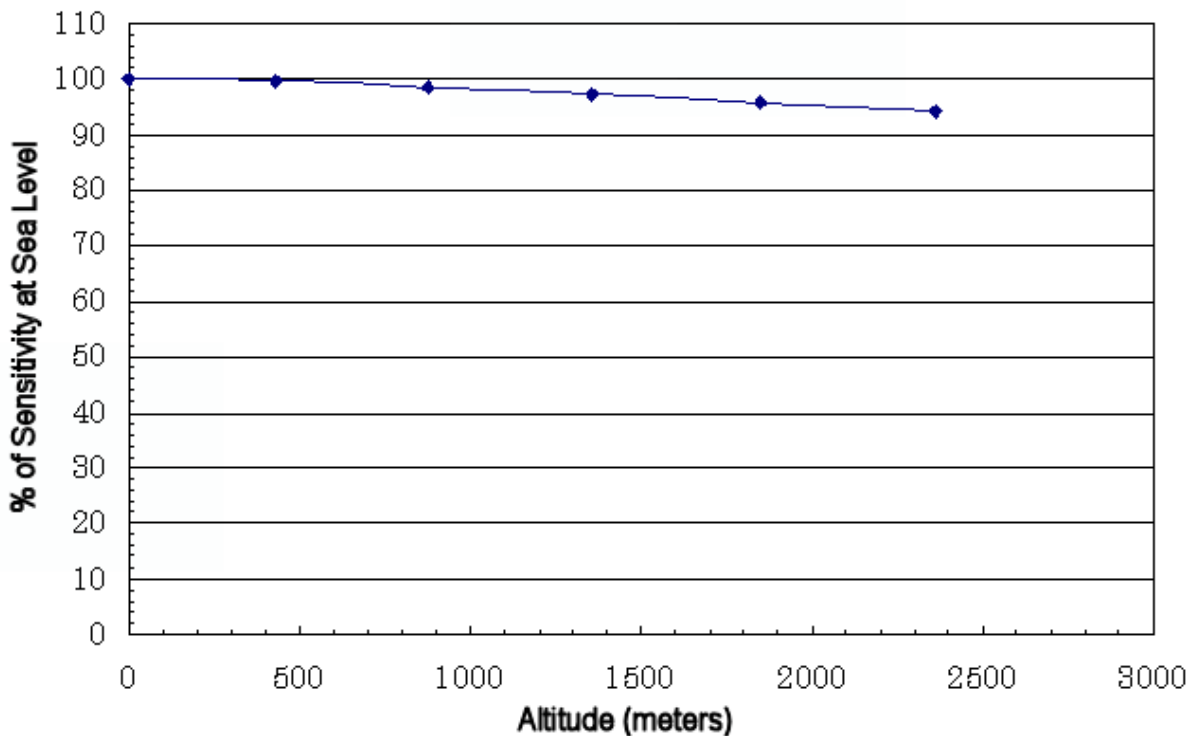



## Initial Start-up Time

During storage, the electrical potential between the electrodes of the NAP-505 drifts. When the sensor is first fitted to its circuit, this potential dissipates quickly, resulting in an initial spike of current, which will be less than 300mA and of very short duration (nS). The output of the sensor then quickly settles to zero within a few seconds (assuming no CO is present). The time taken for the sensor to settle down on initial switch-on varies slightly according to how long the sensor has been stored without power. The plots below illustrate the typical start-up profile for a sensor stored for 1 month and 6 months.

After 1 month of storage:

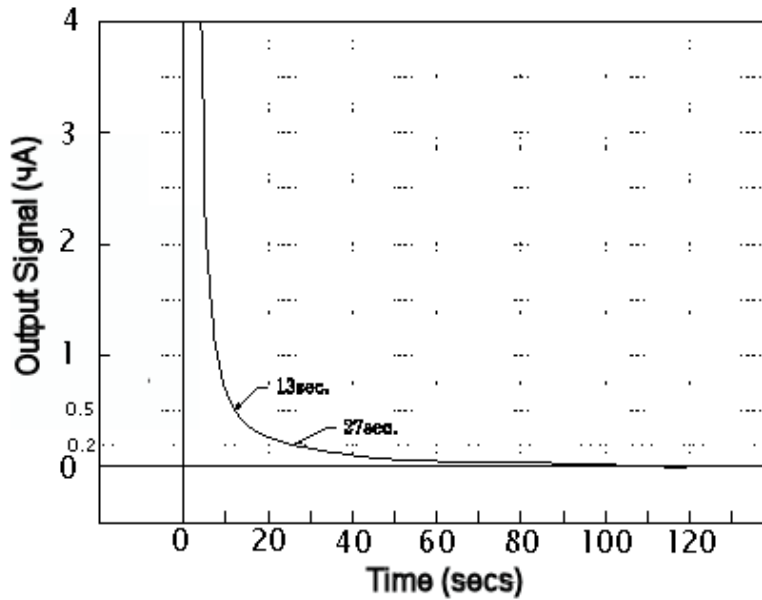

After 6 months of storage:

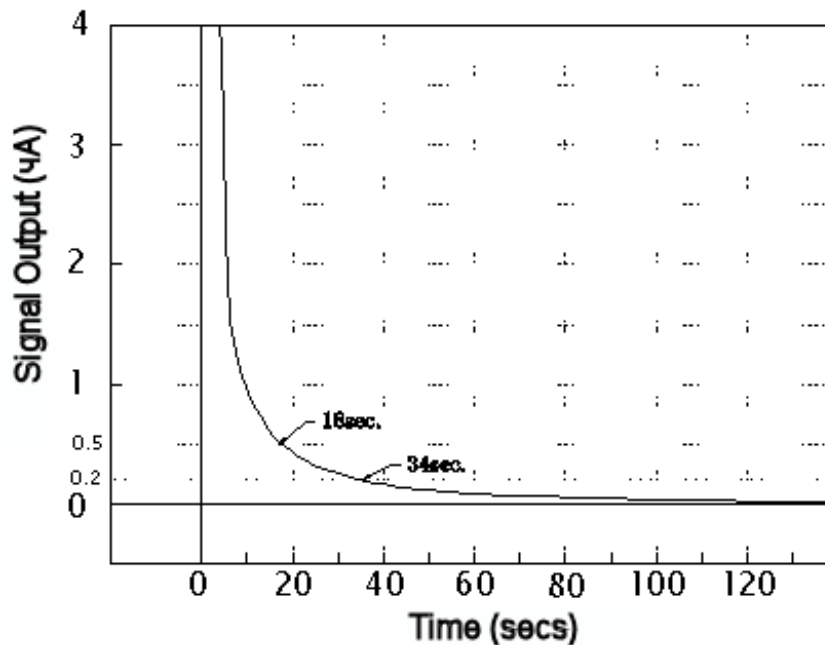



## Temperature dependence

**Effect on Signal Sensitivity:** The figure below shows the mean variation of signal sensitivity with temperature, between -20 and +50 deg C, with  $+2\sigma$  and  $-2\sigma$  limits. The value at 20 deg C is assumed to represent 100%. The instrument designer may decide that temperature correction is required for a particular application. Nemoto provides guidance on analogue temperature compensation circuits later in this manual.

(n=70)

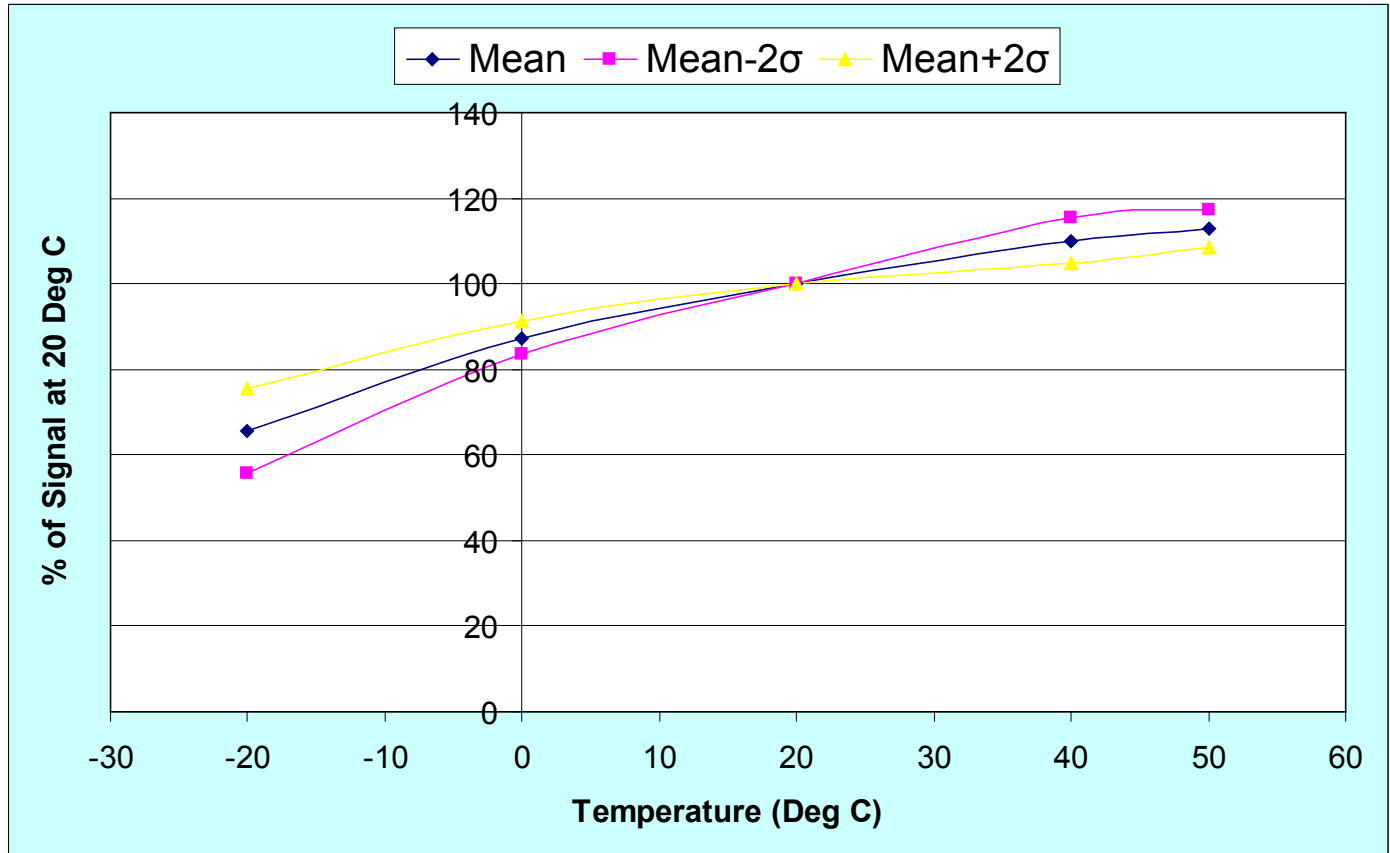

**Effect on Zero.** The figure below (next page) shows the variations of zero offset in nA with temperature, between -20 and +50 deg C, for a statistically significant sample of sensors.

It can be seen clearly that there is a relationship between the fundamental zero offset (the offset measured at 20 degrees C) and the subsequent observed zero drift with temperature. Sensors with higher fundamental zero offsets tend to also exhibit higher offset drift with temperature. The instrument designer may decide that temperature correction is required for a particular application. Nemoto provides guidance on analogue temperature compensation circuits later in this manual.

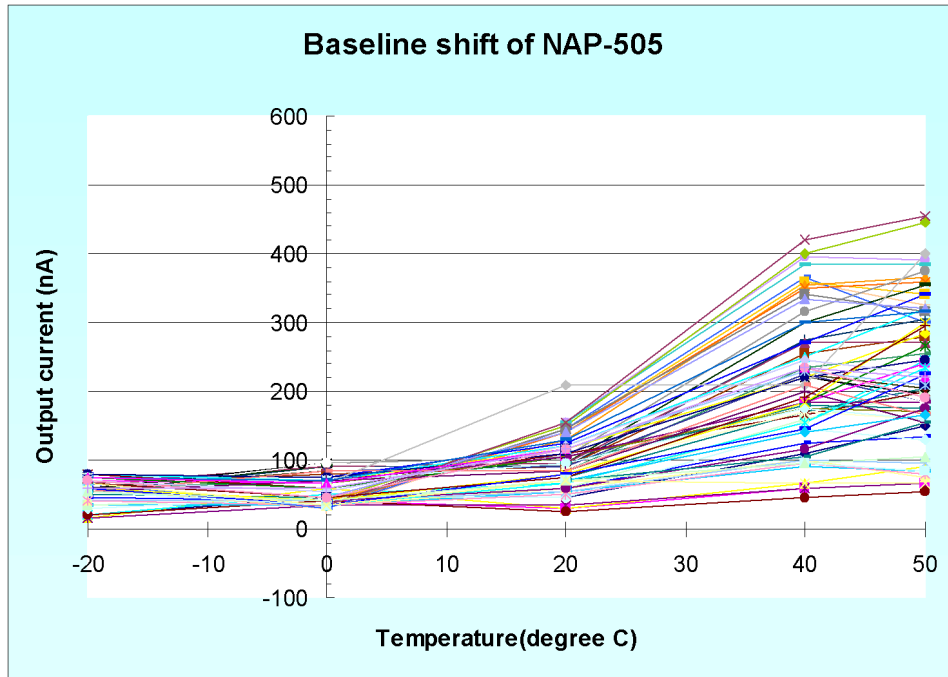

## Wind and Flow-Rate Influences

The NAP-505 is designed to work best in "diffusion mode". This means that the sensor samples the air around it by diffusion with no wind effects causing the air to be "blown through" the capillary into the sensor. The external porous ptfе layer covering the capillary both protects the sensor against contamination by dust and liquids, and also acts as a buffer against the mass transport of gas through the capillary.

Placing the sensor in direct draughts with no protection against wind effects will have a small effect on the sensitivity of the sensor. The figure below illustrates the effect of a wind imposed on the sensor, directed straight at the sensor's capillary, up to a maximum wind speed of 2m/sec.

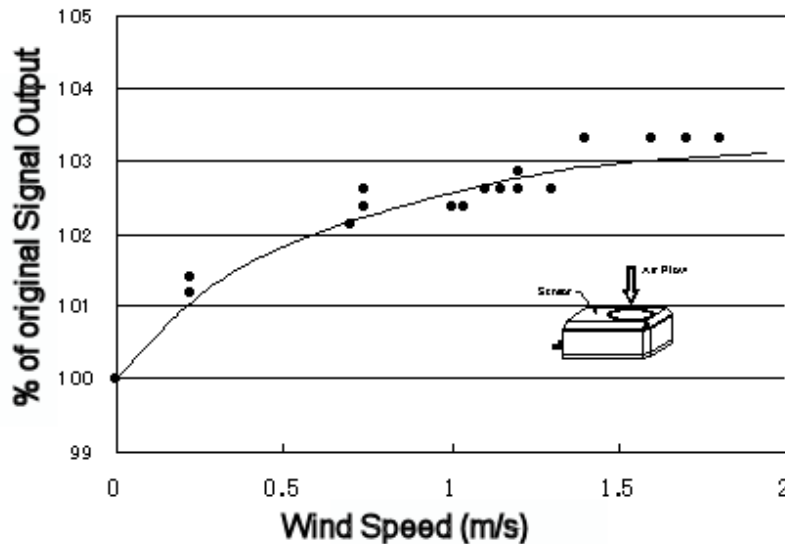



## Long Term Stability

The Figure below illustrates the typical long term zero stability over three years, with  $-2\sigma$  and  $+2\sigma$  limits:

(n=20)

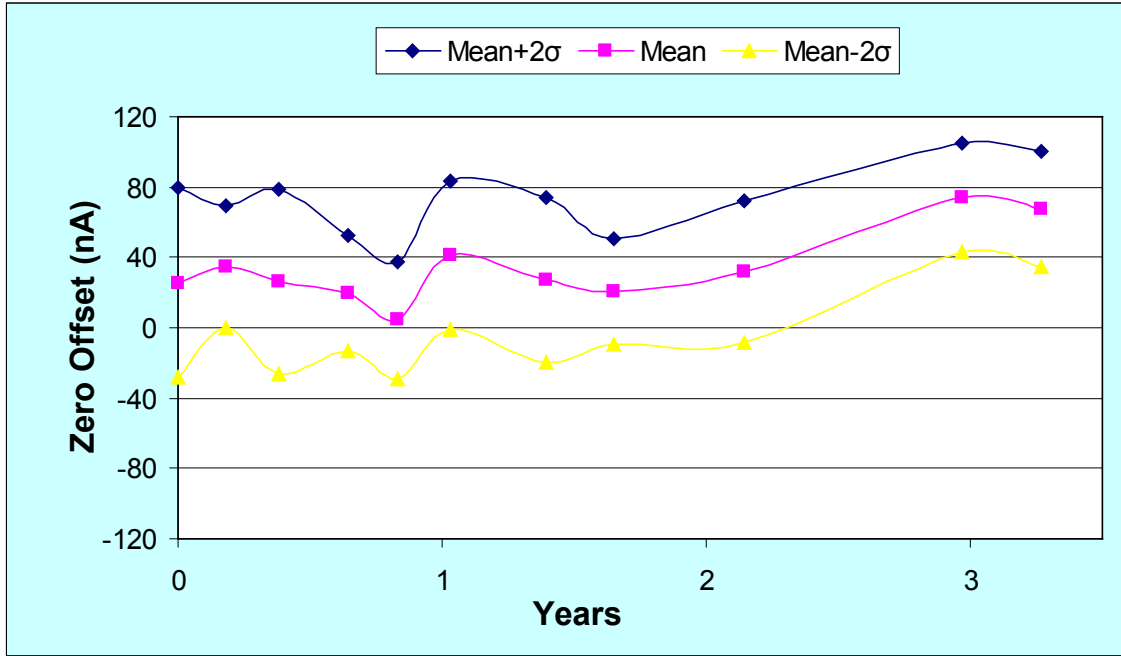

The Figure below illustrates the typical long term span (gas signal) stability over 6 years, with  $-2\sigma$  and  $+2\sigma$  limits:

(n=20)

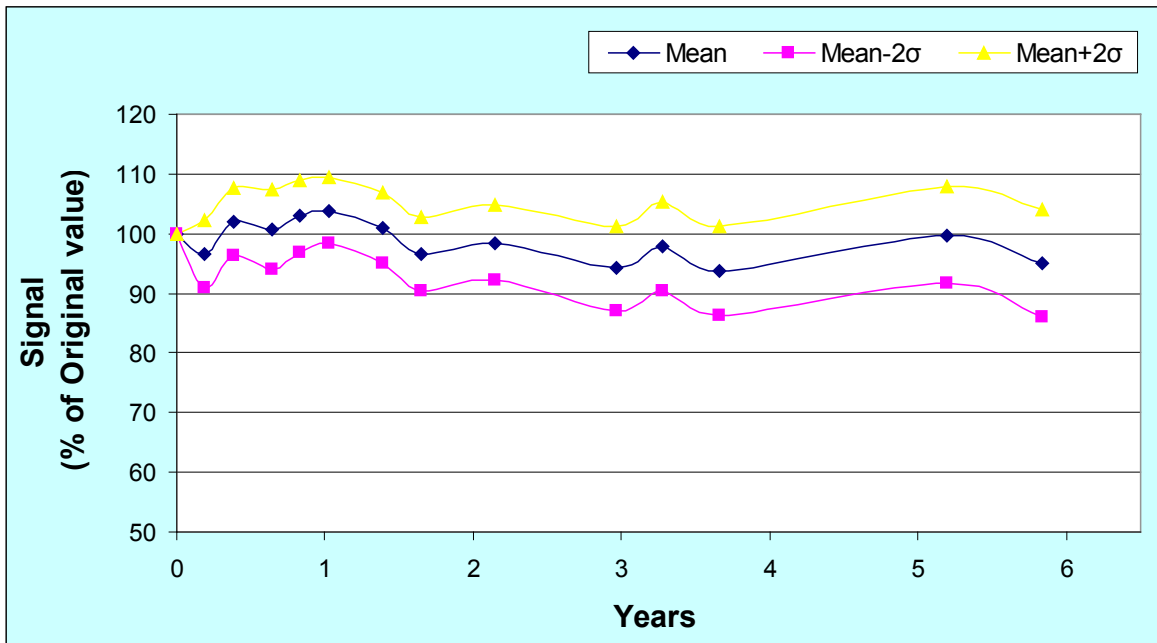



## Long Term Stability - Variation between Production Lots

The three figures below represent long term Span stability results for a sample of sensors from three different production runs:

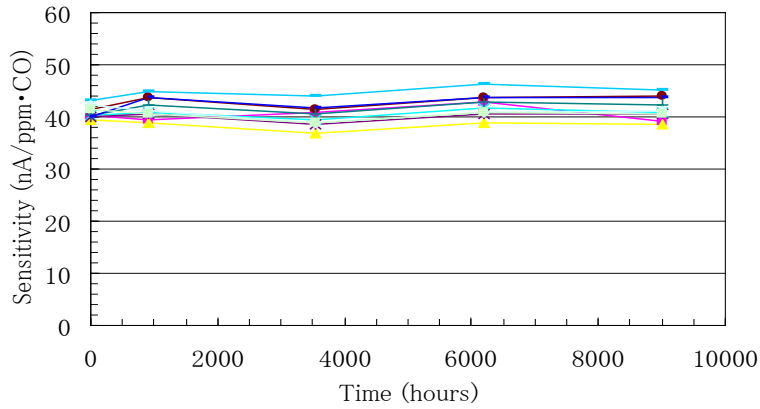

Lot A

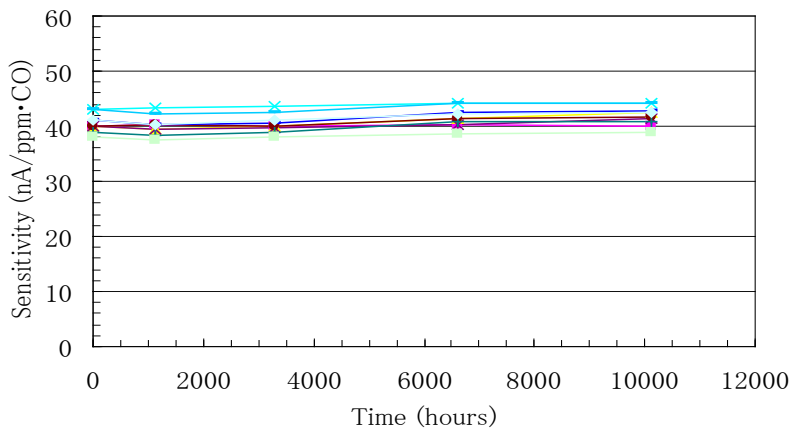

Lot B

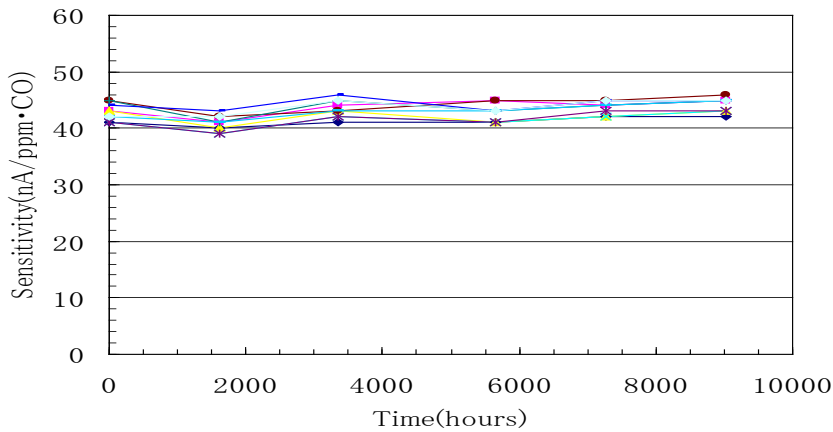

Lot C



## Tolerance to Environmental Extremes

### Storage in High Temperature and Humidity:

Nemoto recommends that sensors are stored sensibly in a cool (between 0 and +20 deg C) place, with normal ambient humidity. They should not be stored in a refrigerator, since the cooling mechanism can remove water from the atmosphere, resulting in very low storage humidity.

However, Nemoto Gas Sensors have been designed to be highly resistant to abusive storage conditions, so if the sensors are accidentally stored in less than ideal conditions (within reason), no significant loss of performance in service will result.

The figure below illustrates the change in sensitivity output of the NAP-505 when stored continuously at 50 deg C and a humidity of 90% RH, for 6 months:

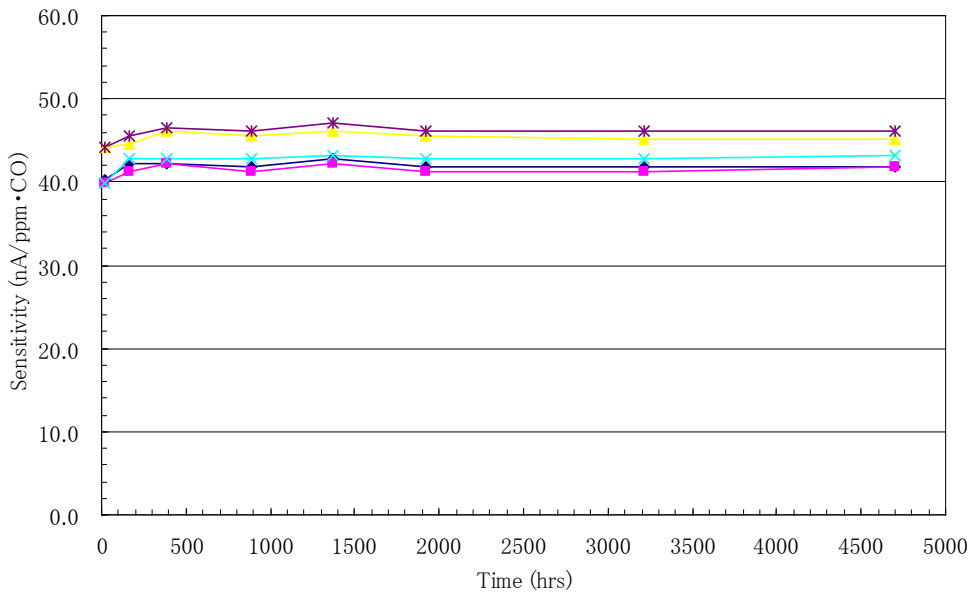

The sensors in this test were then stored in normal room condition to allow the electrolyte to re-establish a normal equilibrium. After a further 4 weeks in these conditions, the sensors were retested to confirm that the sensors had suffered no significant effect on their performance. The sensitivity signal of the sensors before and after the test is shown in the table below:

No.	Sensitivity to CO (nA/ppm CO)		Change ratio (%)
	Before test	After test	
1	40.3	40.5	0.5
2	39.8	41.5	4.1
3	44.2	44.4	0.5
4	39.8	41.5	4.1
5	44.2	44.4	0.5





### Storage in High Temperature and Low Humidity

The figure below illustrates the change in sensitivity output of the NAP-505 when stored continuously at 50 deg C and a humidity of less than 15% RH, for 6 months:

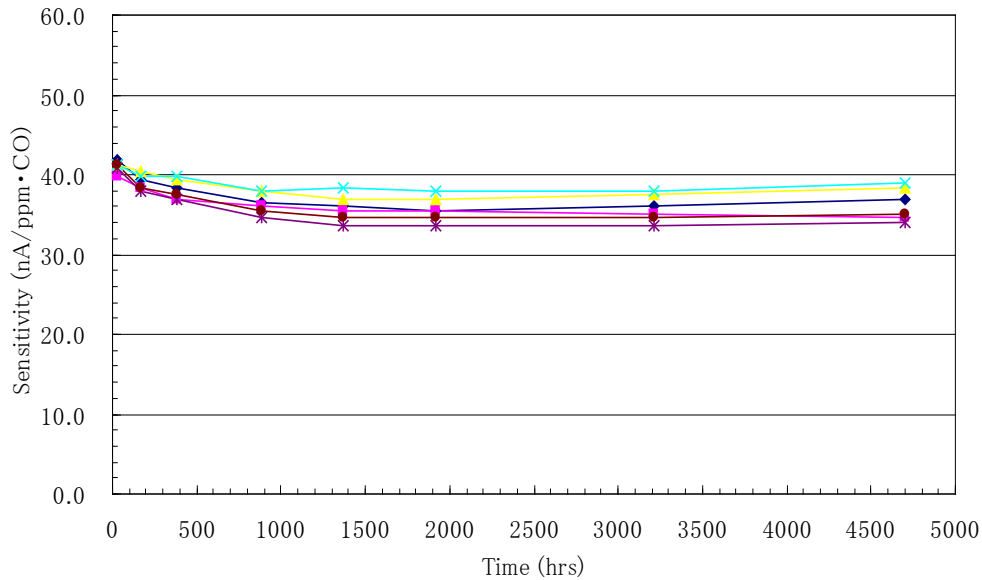

The sensors in this test were then stored in normal room condition to allow the electrolyte to re-establish a normal equilibrium. After a further 4 weeks in these conditions, the sensors were retested to confirm that the sensors had suffered no significant effect on their performance. The sensitivity signal of the sensors before and after the test is illustrated in the table below:

No.	Sensitivity to CO (nA/ppm CO)		Change ratio (%)
	Before test	After test	
1	41.8	39.7	-5.0
2	39.8	38.4	-3.5
3	41.3	39.7	-3.9
4	41.3	40.7	-1.5
5	40.8	37.8	-7.4
6	41.3	38.4	-7.0



### Storage in Low Temperature

The figure below illustrates the change in sensitivity output of the NAP-505 when stored continuously at -20 deg C for 6 weeks:

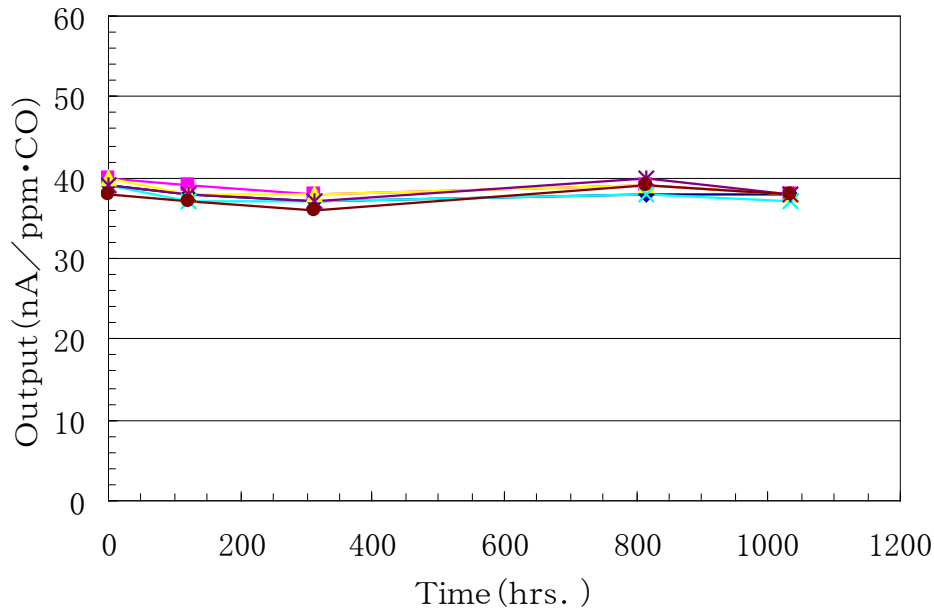

### Transient Temperature cycling tests (Heat Shock)

The table below illustrates the effect on the sensors when cycled between low and high temperatures. The sensors were maintained at -20 deg C for 30 minutes, and then suddenly moved to a chamber at +50 deg C for 30 minutes. This was repeated 10 times. The sensors were tested for zero offset and sensitivity signal before and after the cycling.

No.	CO gas sensitivity characteristics (micro A)			
	Before Cycling		After Cycling	
	Zero offset	CO sensitivity	Zero offset	CO sensitivity
1	0.10	4.1	-0.10	4.1
2	0.12	4.3	-0.03	4.2
3	0.08	4.1	-0.05	4.0
4	0.08	4.2	-0.07	4.2
5	0.15	4.2	+0.04	4.2



## Tolerance to Over-Range Concentrations of CO

One of the many benefits enjoyed by three electrode CO sensors compared with two electrode designs is the ability to perform during, and tolerate, over-range conditions. The table below illustrates the effect of exposure to 5,000 ppm CO continuously for 15 hours. In each case the sensors were tested for zero offset and sensitivity signal, before and after the exposure, using 200ppm CO test gas.

Sensor No.	Before Exposure to 5000ppm CO / 15 hours				After Exposure to 5000ppm CO / 15 hours			
	Zero Offset (μA)	Signal for 200ppm CO (μA)	Signal - Zero (μA)	Sensitivity (nA/ppm CO)	Zero Offset (μA)	Signal for 200ppm CO (μA)	Signal - Zero (μA)	Sensitivity (nA/ppm CO)
1	0.09	8.15	8.06	40.3	0.02	8.10	8.08	40.4
2	0.06	8.41	8.35	41.8	0.02	8.50	8.48	42.4
3	0.04	8.44	8.40	42.0	-0.06	8.30	8.36	41.8
4	0.08	8.16	8.08	40.4	0.02	8.02	8.00	40.0
5	0.10	7.97	7.87	39.4	0.03	7.76	7.73	38.7
6	0.08	8.28	8.20	41.0	-0.05	8.07	8.12	40.6
7	0.14	8.02	7.88	39.4	0.01	7.75	7.74	38.7
8	0.14	8.55	8.41	42.1	0.05	8.37	8.32	41.6
9	0.06	8.41	8.35	41.8	0	8.22	8.22	41.1
10	0.08	8.69	8.61	43.1	-0.01	8.48	8.49	42.5

The table below illustrates the effect of exposure to 594 ppm CO continuously for 10 days. In each case the sensors were tested for zero offset and sensitivity signal, before and after the exposure, using 200ppm CO test gas.

Sensor No.	Before Exposure to 594ppm CO / 10 days				After Exposure to 594 ppm CO / 10 days			
	Zero Offset (μA)	Signal for 200ppm CO (μA)	Signal - Zero (μA)	Sensitivity (nA/ppm CO)	Zero Offset (μA)	Signal for 200ppm CO (μA)	Signal - Zero (μA)	Sensitivity (nA/ppm CO)
1	0.19	8.24	8.05	40.3	0.07	8.34	8.27	41.4
2	0.03	8.03	8.00	40.0	0.06	8.30	8.24	41.2
3	0.07	8.18	8.11	40.6	0.06	8.44	8.38	41.9
4	0.03	8.24	8.21	41.1	0.05	8.45	8.40	42.0
5	0.06	8.12	8.06	40.3	0.05	8.35	8.30	41.5
6	0	8.12	8.12	40.6	0.12	8.49	8.37	41.9
7	-0.18	7.67	7.85	39.3	0.05	8.16	8.11	40.6
8	0.07	8.06	7.99	40.0	0.08	8.30	8.22	41.1
9	-0.03	8.13	8.16	40.8	0.07	8.46	8.39	42.0
10	0.04	8.10	8.06	40.3	0.10	8.39	8.29	41.5



## Tolerance to Corrosive / Interfering Gases

### Sulphur Dioxide

The following table illustrates the NAP-505's tolerance to corrosive levels of SO<sub>2</sub>. 4 sensors were exposed to 500ppm of SO<sub>2</sub> at room temperature and humidity, for 30 minutes. The sensors were tested for sensitivity to CO, using 100ppm CO gas, both during the exposure to SO<sub>2</sub>. (ie whilst the SO<sub>2</sub>. was present), and also in clean air following the exposure.

Sensor No.	Sensitivity characteristics. Exposure to SO <sub>2</sub>			
	CO sensitivity before Exposure (µA)	Zero change during exposure	CO sensitivity during exposure (µA)	CO sensitivity after exposure (µA)
1	4. 2	0	4. 1	4. 2
2	4. 2	0	4. 0	4. 1
3	4. 1	0	4. 0	4. 1
4	4. 4	0	4. 3	4. 3

It was founds that the effect of SO<sub>2</sub>. on the sensor, both during and following the exposure, was negligible.

### Nitrogen Dioxide

The following table illustrates the NAP-505's tolerance to corrosive levels of NO<sub>2</sub>. 4 sensors were exposed to 800ppm of NO<sub>2</sub> at room temperature and humidity. The sensors were tested for sensitivity to CO, using 100ppm CO gas, both during the exposure to SO<sub>2</sub> (ie whilst the NO<sub>2</sub> was present), and also in clean air following the exposure.

Sensor No.	Sensitivity characteristics. Exposure to NO <sub>2</sub>			
	CO sensitivity before Exposure (µA)	Zero change during exposure (µA)	CO sensitivity during exposure (µA)	CO sensitivity after exposure (µA)
1	4. 0	1. 4	5. 1	4. 0
2	4. 2	1. 2	5. 6	4. 2
3	4. 2	1. 6	6. 0	4. 2
4	3. 9	1. 3	5. 0	3. 9

It was found that during this exposure there was a small effect on the zero of the sensor (approx 5% with respect to the CO sensitivity), and the exposure also had a small effect on the sensitivity to CO during the exposure, but following the test the effect on the sensor's performance was negligible.



## Acetone

The following table illustrates the NAP-505's tolerance to high levels of Acetone. 3 sensors were exposed to 1,500 ppm of Acetone at room temperature and humidity for 60 minutes. The sensors were tested for zero change during the exposure and sensitivity to CO, using 100ppm CO gas, before and after the exposure.

Sensor No.	Sensitivity characteristics. Exposure to Acetone (1,500ppm)		
	CO sensitivity before Exposure ( $\mu\text{A}$ )	Zero Offset Change during exposure ( $\mu\text{A}$ )	CO sensitivity after Exposure ( $\mu\text{A}$ )
1	4.5	0	4.6
2	4.4	0	4.5
3	4.3	0	4.4

It was found that the effect of Acetone on the sensor, both during and following the exposure, was negligible.

## Ethanol

The following table illustrates the NAP-505's tolerance to high levels of Ethanol. 5 sensors were exposed to 2,000 ppm of Ethanol at room temperature and humidity, for 30 minutes. The sensors were tested for zero change during the exposure and sensitivity to CO, using 100ppm CO gas, before and after the exposure.

Sensor No.	Sensitivity characteristics. Exposure to Ethanol (2,000ppm)			
	CO sensitivity before Exposure ( $\mu\text{A}$ )	Zero Offset Change at 30 minutes Exposure ( $\mu\text{A}$ )	Maximum Zero Offset Change in clean air after Exposure ( $\mu\text{A}$ )	CO sensitivity after Exposure ( $\mu\text{A}$ )
1	4.3	0	0.4	4.4
2	4.4	-0.4	0.6	4.4
3	4.6	-0.5	0.8	4.7
4	4.5	-0.3	0.9	4.5
5	4.3	-0.2	0.5	4.4

It was found that the zero offset of the NAP-505 drifted slightly negative during the exposure, and drifted slightly positive following the exposure, but the zero returns to its previous value after a short while. The sensor's performance returned to previous values following the exposure.



## Hexamethyldisiloxane (HMDS)

The following table illustrates the NAP-505's tolerance to high levels of HMDS, a commonly encountered silicone vapour. 8 sensors were exposed to 100 ppm of HMDS at room temperature and humidity, for 60 minutes. The sensors were tested for zero change and output sensitivity, using 100ppm CO gas, before and after the exposure, and the sensors were tested again after 24 hour in clean air.

Note that for this test the sensors used were fabricated without the in-board filter. In reality the filter would remove HMDS, but for this test it was considered that to test the sensors without the filter would be more meaningful.

Sensor No.	Characteristics before exposure		Characteristics following exposure		Characteristics 24 hours after exposure	
	Zero offset in clean air ( $\mu\text{A}$ )	CO gas sensitivity ( $\mu\text{A}$ )	Zero offset in clean air ( $\mu\text{A}$ )	CO gas sensitivity ( $\mu\text{A}$ )	Zero offset in clean air ( $\mu\text{A}$ )	CO gas sensitivity ( $\mu\text{A}$ )
1	0.18	4.3	0.27	4.3	0.10	4.3
2	0.19	4.3	0.34	4.2	0.10	4.3
3	0.18	4.2	0.29	4.2	0.07	4.2
4	0.15	4.3	0.23	4.2	0.06	4.2
5	0.14	4.4	0.18	4.3	0.08	4.3
6	0.17	4.2	0.21	4.2	0.09	4.2
7	0.17	4.3	0.13	4.2	0.08	4.2
8	0.19	4.2	0.17	4.2	0.09	4.2

It was found that HMDS has no significant effect on the sensor either during or after the exposure

## Tolerance to Vibration

In this test, 5 sensors were exposed to vigorous vibration for 2 hours. The vibrations were of amplitude 1.5mm, with a sweep time of 10 – 55 – 10 Hz, in the all three planes X, Y and Z. Humidity and Temperature during this test were normal ambient conditions. The sensors were tested for CO gas sensitivity, using 100ppm CO test gas, before and after the vibration.

The results are illustrated in the table below. No significant effect was detected.

Sensor No.	CO gas sensitivity ( $\mu\text{A}$ )	
	Before test	After test
1	4.2	4.2
2	4.3	4.4
3	4.3	4.4
4	4.2	4.2
5	4.3	4.5
6	4.3	4.4



## Tolerance to Shock (Drop Test)

In this test, 10 sensors were dropped from a height of 1m onto a concrete floor. The sensors were dropped three times. The sensors were tested for zero offset and CO gas sensitivity, using 100ppm CO test gas, before and after the shocks were applied.

The results are illustrated in the table below. No significant effect was detected.

Sensor No.	Gas sensitivity characteristics			
	Before test		After test	
	Zero offset in clean air ( $\mu\text{A}$ )	CO gas sensitivity ( $\mu\text{A}$ )	Zero offset in clean air ( $\mu\text{A}$ )	CO gas sensitivity ( $\mu\text{A}$ )
1	0.12	4.1	0.12	4.1
2	0.09	4.1	0.07	4.1
3	0.09	4.1	0.13	4.1
4	0.06	4.1	0	4.1
5	0.12	4.2	0.09	4.3
6	0.09	4.2	0.12	4.2
7	0.10	4.1	0.11	4.2
8	0.12	4.0	0.09	4.0
9	0.11	3.8	0.06	3.9
10	0.16	4.1	0.15	4.1



## Tests Specific to International Standards:

### Continuous exposure to 15ppm of CO for 1 year (UL 2075):

As part of component recognition to UL standard to UL2075, it is required that the sensor is exposed to 15ppm CO continuously for 1 year. The sensitivity of the NAP-505 in nA/ppm, for the duration of the test, is shown in the plot below:

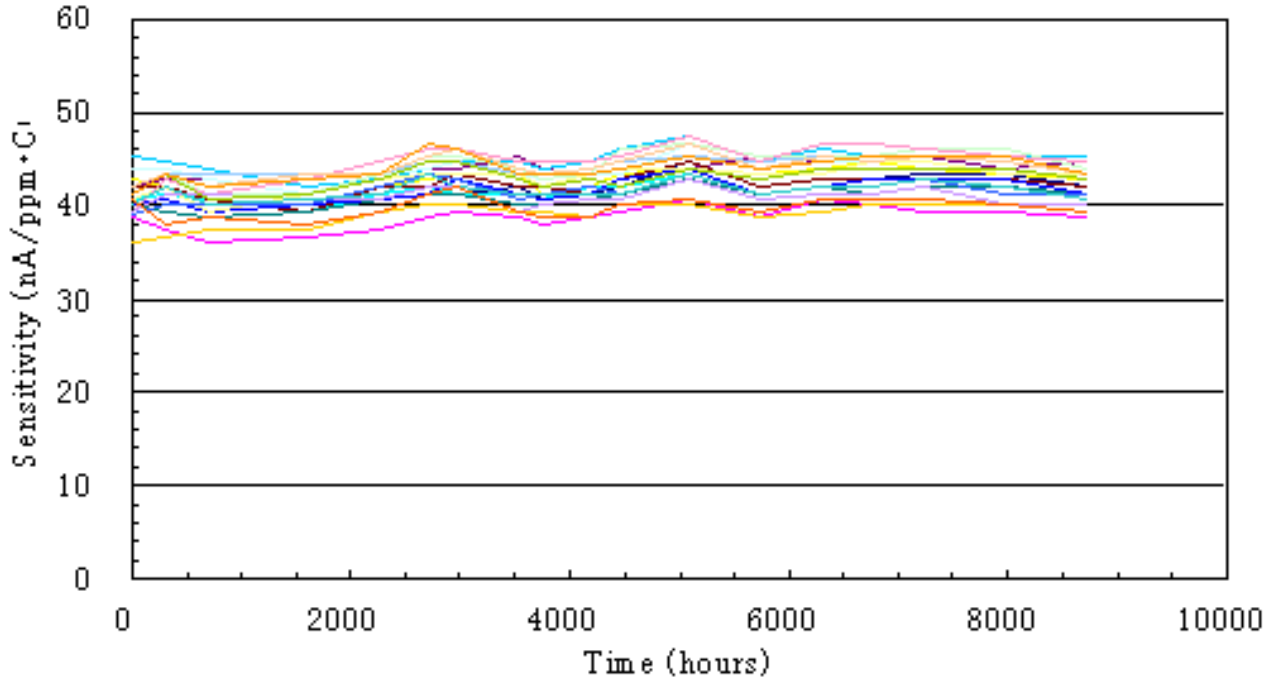

The sensitivity of the sensor before and after the test is also illustrated in the table below:

CO test gas Concentration (ppm)	30	70	150	400
Initial Sensitivity (nA/ppm) Dated 18/10/2003	40.3	40.5	40.1	40.9
Sensitivity after test (nA/ppm) Dated 29/10/2004	41.4	40.2	39.8	39.4
% Change	+2.7	-0.7	-0.7	-3.7
Max/Min % Change	+7.6 / +2.4	-3.6 / +0.3	-3.2 / +0.3	-6.4 / -2.8

24 samples were used for this test. During the test, the temperature was maintained at 25 +/- 3 deg C, and the humidity maintained at 50 +/- 20%RH. The test gases used were as defined in UL2034





### 5000ppm CO over-range exposure (EN50291)

It is a requirement of the EN50291 standard that the sensor recovers to a steady initial zero following an exposure to 5000ppm CO for 15 minutes. Many sensors, including some 2-electrode electrochemical types, struggle to pass this test, exhibiting a negative zero drift following the exposure.

Being a three electrode design, the NAP-505 has no difficulty passing this test, the sensor being ready to reliably detect hazardous levels of CO within 60 minutes following the over-range exposure. The results are illustrated in the plot below:

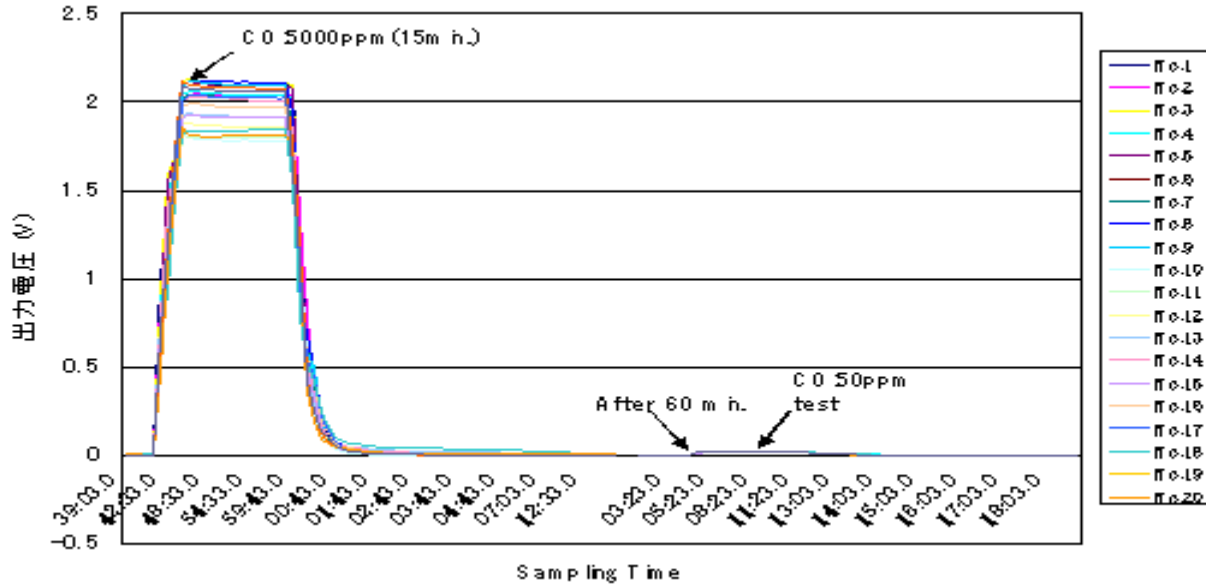



## Recommended Circuitry

### 1) Basic operational circuit

This circuit uses an OP97 operational amplifier, which is easily obtainable and relatively low power. The temperature dependency of NAP-505 is compensated by NTC thermistor that has 3435K of B constant made by Ishizuka Denshi. Thus the output accuracy can be within  $\pm 10\%$  in the range of  $-10^{\circ}\text{C} \sim 50^{\circ}\text{C}$ . Any thermistor with a B-constant around 3500K and resistance value ( $R_{25}$ ) of 10 K $\Omega$  can be used.

The Temperature compensation gained by this circuit relates to Span (Sensitivity) changes only. Zero offset changes with temperature are not compensated for in this circuit, but can optionally be accommodated either by a different, more complex thermistor matrix or in software.

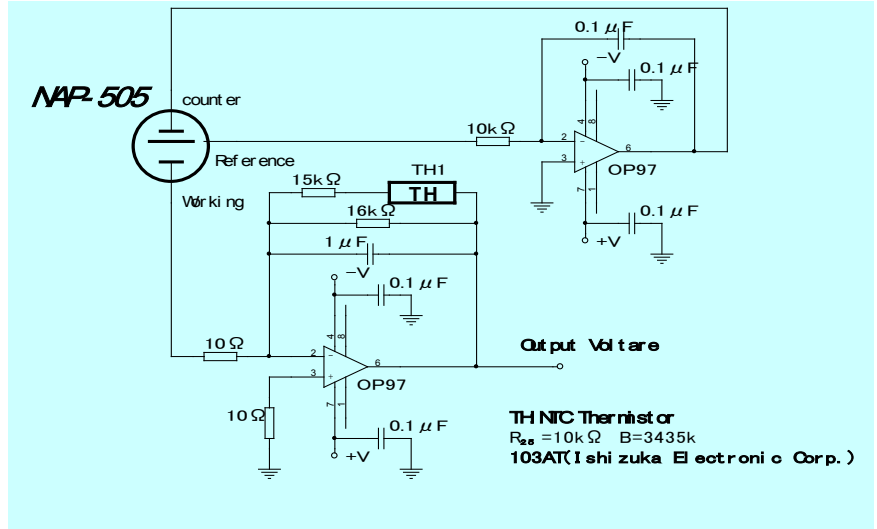

### 2) Low power consumption circuit

For general operational circuits, operational amplifiers such as OP97 used in our recommended circuit or classical OP07 can be used without problems. However for battery-operated circuits for portable devices, lower power consuming operational amplifiers are required. For example, the NJM4250 works at as low as 0.1 mA (max) with a supply voltage of  $\pm 1\text{V} \sim \pm 18\text{V}$ . For simpler circuits with single power supply, battery-operation with 2 ~ 3 V is possible and OP90 (20 $\mu\text{A}$ max) or the like can be used.

For a longer battery life, a pulsed operation may be utilised, e.g. 2 minute-off after 30-second operation, in order to save battery power consumption.

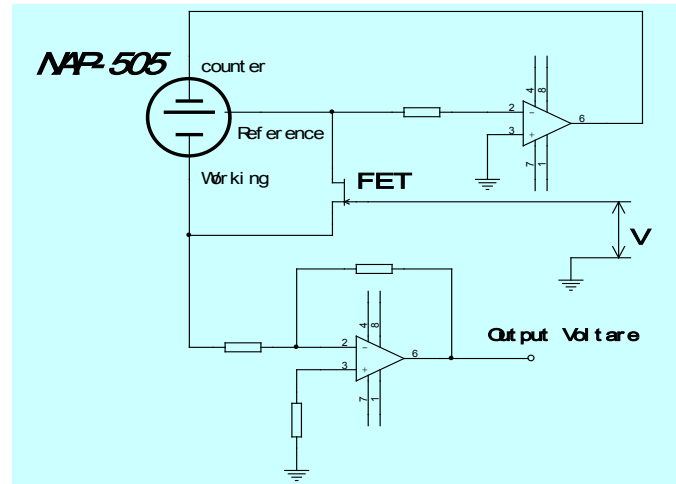

When using an electrochemical sensor in cycled operation, transient signals may be seen just after power on and power off. Under normal operation 1 ~ 2 minutes would be required for output stabilization. To eliminate this effect it is necessary to maintain a short-circuit between the working electrode (W) and the reference electrode (R) when the power supply is off. In this example the short-circuit is maintained using a FET so that the short is automatically broken during the power supply is on. Using this approach, the output is stabilized within 10 seconds after the power on. Sampling the output signal just before the power off enables accurate measurement data whilst saving battery power consumption.



### 3) Battery operation

When exposed to CO gas, the potential of the counter electrode will need to move negative in respect to the working electrode. When a single power source (i.e. battery or D.C.) is used, it is necessary to maintain a virtual zero above 0V to allow optimal electrochemical performance. In this case, we recommend that this is between 0.5 ~ 1.0V.

This ensures a linear signal across the full measurement range. However if strict measurement results are not required in the range less than 50ppm, this virtual zero may not be needed.

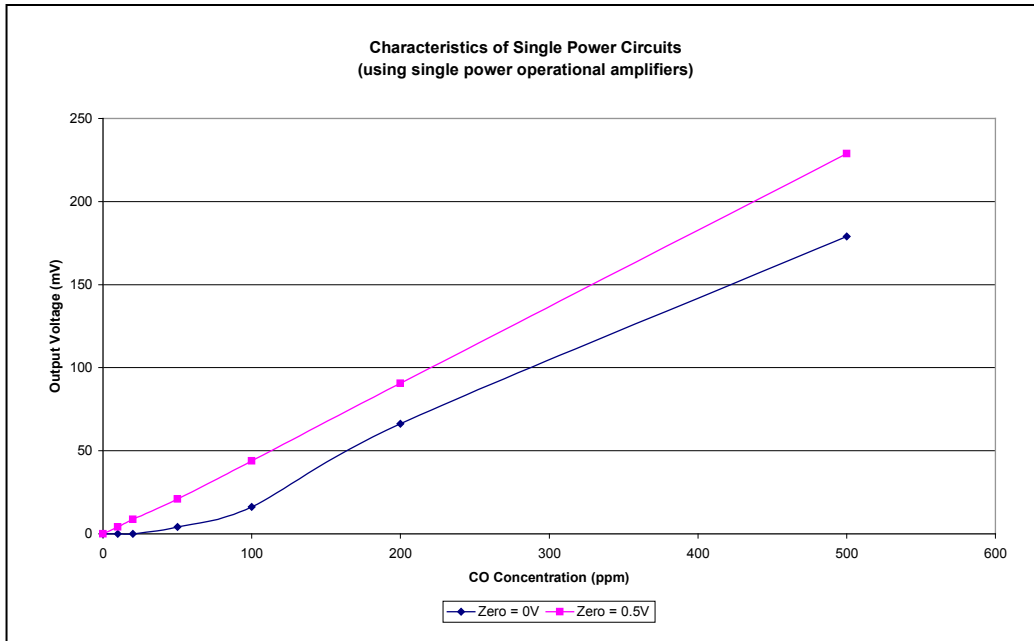
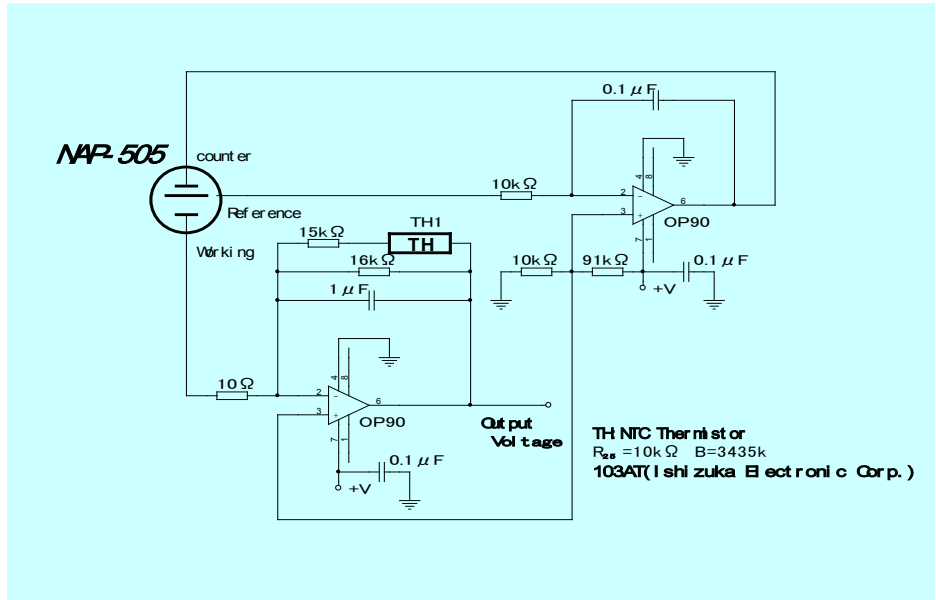

**Note:** These notes on Recommended Circuitry are not intended to be compulsory or prescriptive, and we at Nemoto are mindful that our customers are expert circuitry designers, often with excellent ideas of their own. We would, however, appreciate being consulted if this guidance is to be significantly deviated from.



#### 4) A Selection of Suitable Operational Amplifiers

The following table lists a selection of Op-amps which Nemoto has found to be suitable for use with electrochemical gas sensors generally. This list is not exhaustive, and Nemoto cannot guarantee the availability of all of these devices in all territories. The information here was correct at the time of writing, but the manufacturers may change specifications without notice.

Type		Item Code	Brand	I <sub>10</sub>	V <sub>10</sub>	I <sub>B</sub>	I <sub>CC</sub>	Remarks
Amps per Pkg	Power Supply							
Single	Dual	NJM741	JRC	5.0	2.0	30	1.7	General Purpose Low Cost
Dual	Dual	HA17458	Renesas	6.0	2.0	30	6.0	
Quad	Dual	μPD458	NEC	50	5.0	300	7.0	
Dual	Single	LM358	NS	5.0	2.0	45	0.5	
Quad	Single	LM324	IT	8.0	7.0	250	1.2	
Single	Dual	OP-07	AD	6.0	0.15	7.0	5.0	Medium Cost Higher Quality
Dual	Dual	TL082	NS	0.2	15	0.05	3.5	
Quad	Dual	NJM084	JRC	0.2	15	0.4	11.2	
Single	Single	OP-191	AD	8.0	0.5	50	0.4	
Dual	Single	HA17904	Renesas	2.0	3.0	30	0.8	
Quad	Single	OP-491	AD	8.0	0.7	30	1.6	Higher Cost for Very High Quality Instruments
Single	Dual	OP-97	AD	0.15	0.075	0.15	0.6	
Dual	Dual	OP-297	AD	0.15	0.1	0.15	1.25	
Quad	Dual	OP-497	AD	0.2	0.15	0.2	2.5	
Single	Single	OP-90	AD	5.0	0.25	25	0.02	
Dual	Single	OP-290	AD	5.0	0.5	25	0.04	
Quad	Single	OP-490	AD	5.0	1.0	25	0.08	Low Power consumption For Battery Operated Instruments
Single	Single	μPD4250	NEC	20	6.0	75	0.1	
Single	Single	NJU7001	JRC	5.0	1.0	1.0	0.015	
Single	Single	HA1630S01	Renesas	1.0	4.0	1.0	0.03	
Single	Single	LPV-511	NS	0.02	0.4	0.11	0.04	
Quad	Single	LPV-321	TI	1.0	7.0	50	0.012	

Note: If a CMOS - type Op-Amp is used, it is possible that the resulting output could include undue noise, and the instrument designer may need to include additional measures to reduce or remove this.

<b>Key:</b>	I <sub>IO</sub>	= Input Offset Current (max)	V <sub>IO</sub>	= Input Offset Voltage (max)
	I <sub>B</sub>	= Input Bias Current (max)	I <sub>CC</sub>	= Power Consumption (max)
	NEC	= NEC Corporation	<a href="http://www.nec.com">http://www.nec.com</a>	
	JRC	= New Japan Radio Co., Ltd.	<a href="http://www.njr.co.jp">http://www.njr.co.jp</a>	
	Renesas	= Renesas Technology Corp.	<a href="http://www.renesas.com">http://www.renesas.com</a>	
	NS	= National Semiconductor Corp.	<a href="http://www.national.com">http://www.national.com</a>	
	AD	= Analogue Devices, Inc.	<a href="http://www.analog.com">http://www.analog.com</a>	
	TI	= Texas Instruments, Inc.	<a href="http://www.ti.com">http://www.ti.com</a>	



## Notes on Instrument Design and Handling Considerations

### **Long Term Stability Considerations:**

Although the NAP-505 exhibits excellent long term stability compared with other comparable devices, over time all electrochemical gas sensors slowly but gradually lose sensitivity, as can be seen in the data previously shown in this manual. This should be taken into account during Instrument design.

### **Seasonal Variation of Sensitivity:**

As we have seen in previous section, the Electrolyte used in the NAP-505 is hygroscopic. This means that if the sensor is exposed to very humid conditions over a prolonged period, the volume of electrolyte within the sensor will increase, and likewise will decrease when exposed to very dry conditions over time. In climates with very wide seasonal variations, for example Japan, this can cause a slight but noticeable difference in sensitivity with the seasons. These variations are actually rather less with the NAP-505 (at around +/- 5%) than with other available devices, and have no long term effect on the sensor, but the instrument designer may need to take these into account when designing and specifying instruments.

### **Storage Conditions:**

Nemoto recommends that the NAP-505 is stored in clean air at room temperature and humidity, below 20 degrees C if possible. Do not store them in a refrigerator.

The maximum recommended storage time after delivery is 6 months. If the storage time is longer, then the stated lifetime cannot be guaranteed.

### **Connection and Positioning on a PCB:**

- It is important that the sensor connections are very sound. Loose connections will render the sensor inoperative.
- If a Thermistor is used for temperature compensation, than this should be placed as close to the sensor as possible, and away from potential heat sources such as transformers.
- The sensor will operate properly and to specification in any orientation.

### **Soldering**

- If soldering the sensors, we recommend soldering by hand. The temperature of the soldering iron should be less than 360 degrees C, and the contact time should be less than 5 seconds. If automatic machine soldering must be used, please contact Nemoto for further guidance.
- **The NAP-505 sensor is not suitable for use with Reflow or Wave soldering machines, and they must not be used.**

### **Other handling Considerations:**

- Note that the Performance Data expressed in this document should be considered as typical characteristics for guidance only, and not as specifications which are guaranteed, apart from those in the sections "General Specifications" and "Dimensions". It is the instrument designer's responsibility to ensure that the sensor is suitable for any given application.
- NAP-505 should always be used within its published specifications.
- Gas sensitivity should always be measured with clean, uncontaminated air as the balance gas.
- When designing test equipment, note that turbulent flow of gas close to the sensor can cause a false temporary rise in sensitivity. It is recommended that sensitivity measurements are carried out in a gas filled chamber with only gentle agitation of the test gas.
- If Electrical power is accidentally applied to any of the contact pins, then the sensor should be discarded, since irreparable damage could result.
- Connection pins should never be forced or bent out of position.
- Weights which apply a tension of over 5Kg/cm<sup>2</sup> should not be applied to the sensor housing.
- The circular area on the front face of the sensor marks the area where gas enters the sensor. This should never be blocked or covered, and this area should never be interfered with.



- Although the sensor is shock and Vibration tolerant, care should be taken to prevent undue shocks or vibrations as far as possible
- If the enclosure of the sensor appears damaged in any way, please do not use the sensor.
- Note that if the sensor is exposed to very high levels of CO, it may take some time for the sensor to recover fully to operation within normal parameters.
- Do not apply solvents, glues, paints or any other organic based chemical to the sensor. Do not use contact greases in connection sockets.
- Please do not dissect or dismantle the sensor.
- In the unlikely event of a leaking sensor, please do not touch the electrolyte, since it is corrosive and can burn skin.
- If the internal electrolyte of the sensor comes into contact with skin or eyes, it is recommended that the exposed area is washed with plenty of water as soon as possible.
- It is recommended that expired sensors are discarded professionally in light of their chemical constituents.