

THERMOPILES are used for non-contact surface temperature measuring

Any object emits infrared radiation. The radiation power is increasing with growing surface temperatures. Based on this relation, THERMOPILES measure the emitted power and determine the object temperature precisely.

Function Principle

THERMOPILES are based on the Seebeck effect, which is used since a long time for conventional thermocouples. The application of micromechanics and thin film technology allows the production of miniaturized and cost effective sensor elements.

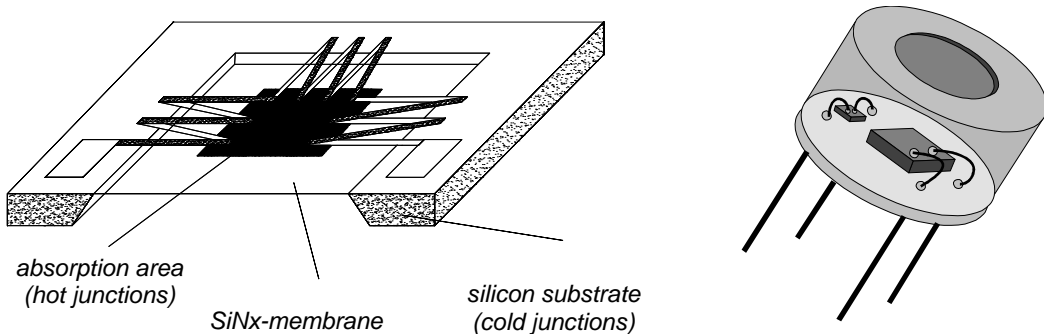

A multitude of thermojunctions deposited on a silicon substrate is connected in series to form a THERMOPILE. The hot junctions are thermally insulated from the cold junctions on the substrate by etching a self-supporting extremely thin membrane. An absorbing layer on the hot junctions transforms the incoming radiation into heat. A voltage proportional to the radiation is generated by the thermoelectric effect. The sensors are delivered in TO5-packages. Different housings and filter types can be selected to find an optimal solution for each application. Chips without housing are available as well.

Technical Data

Parameter	Symbol	Unit	Value	Condition
Number of thermojunctions	n		100	
Material			BiSb, NiCr	
Active Area	A _A	mm ²	0.7 * 0.7	
Chip Size	A _C	mm ²	2.0 * 2.0	
Resistance of Thermopile	R	kΩ	50 ± 15	25 °C
TC of resistance	TCR	% / K	-0.03 ± 0.02	+25...+75 °C
Sensitivity of sensor	S	V / W	typical 90	25°C, 500 K, DC
TC of sensitivity	TCS	% / K	-0.52 ± 0.08	+25...+75 °C
Specific detectivity	D*	cm*Hz ^{1/2} / W	1.7 * 10 ⁸	500 K, DC
Noise equivalent power	NEP	nW	0.41	500 K, 1 Hz
Noise voltage	U _N	nV / Hz ^{1/2}	37	500 K, 1 Hz
Time constant	t ₆₃	ms	40 ± 10	500 K, 1 Hz
Operation temperature	T	°C	-20 ... 100	
Storage temperature	T	°C	-40 ... 100	

Reference Resistor

Resistance	R _{Ni}	Ω	1000 ± 0.4%	0 °C
TC of resistance	TCR _{Ni}	ppm / K	6178 ± 1%	0 °C...100 °C

Function: R(T) = 1000Ω + 6,17*T*Ω, for detailed information see data sheet of reference resistor

Filter

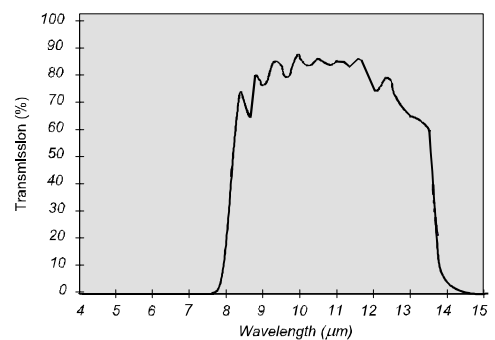

Sensors in thin film technology

HL-Planartechnik GmbH

Hauert 13 44 227 Dortmund Tel.: ++49 / (0)231 / 97400 Fax.: ++49 / (0)231 / 974020

105_34_e_01

March 1999

Connecting Diagramm

TS105-3

TS105-4

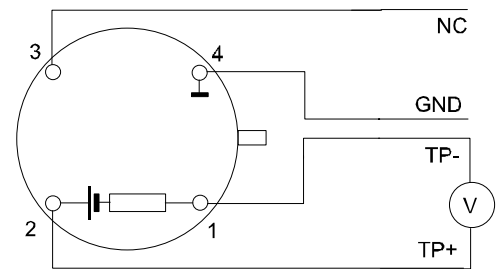
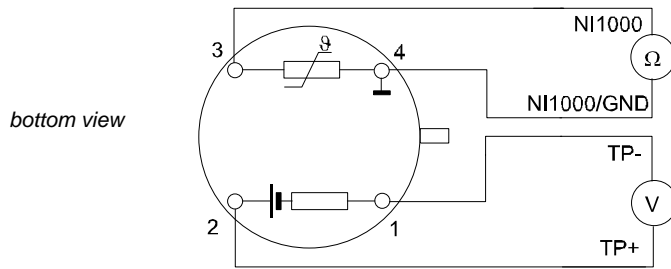

Output Voltage versus Object Temperature

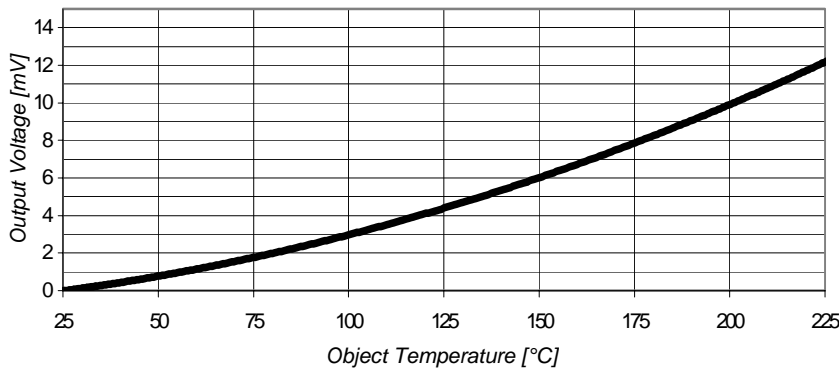

Conditions:
Distance Thermopile/Black Body 5 cm,
emissivity= 1, surrounding temperature 25°C

Tables with emissivity of different materials and surfaces are available.

Housing TO 5

TS105-3

TS105-4

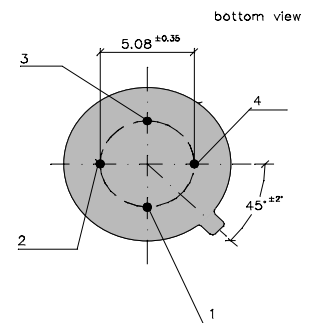
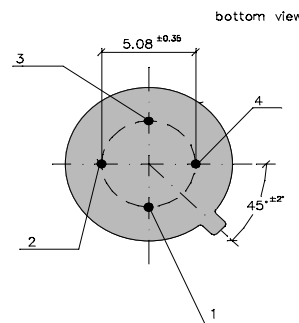
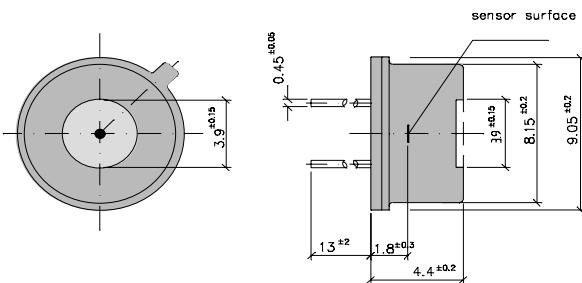

Applications

- contactless measurement of surface temperatures or IR-Radiation
- temperature measurement at moving objects
- continuous temperature control in manufacturing processes
- thermal alarm systems
- further applications in safety-, consumer-, environmental technics and automotive systems
- absorbing measurement for gas analysis (see special data sheet)
- climate control systems
- medical instruments

Further products with different filters and packages are available, see separate data sheets.

Technical data are subject to change without notice.

Sensors in thin film technology

HL-Planartechnik GmbH

Hauert 13 44 227 Dortmund Tel.: ++49 / (0)231 / 97400 Fax.: ++49 / (0)231 / 974020

105_34_e_01

March 1999