

**PROVISIONAL SPECIFICATION SHEET FOR ETHYLENE SENSOR
TYPE C2H4/S-1500****PERFORMANCE CHARACTERISTICS**

Nominal Range	0 – 1500 ppm
Maximum Overload	2000 ppm
Expected Operation Life	1 years in air
Output Signal	12 ± 4 nA/ppm
Resolution	4 ppm
Temperature Range	- 20 °C to 50 °C
Pressure Range	Atmospheric
Pressure Coefficient	No data
T ₉₀ Response Time	< 60 sec
Relative Humidity Range	15 % to 90 % R.H. non-condensing
Typical Baseline Range (pure air, 20°C)	-4 to 16 ppm
Maximum Zero Shift (+20°C to +40°C)	ND
Expected Long Term Output Drift	< 5 % signal loss/month
Recommended Load Resistor	10 Ohm
Bias Voltage	Not recommended
Repeatability	< 2 % of signal
Output Linearity	Linear

CROSS-SENSITIVITY DATA

Interfering Gas	Cross-Sensitivity (%)
CO	< 60 %

Performance data conditions:
20 °C, 50% RH and 1013 mbar

APPLICATIONS

Continuous Air Quality Monitoring

PHYSICAL CHARACTERISTICS

Weight	~ 32 g
Position Sensitivity	None
Storage Life	Six months in container
Recommended Storage Temperature	5 °C – 20 °C
Warranty Period	12 months from date of dispatch

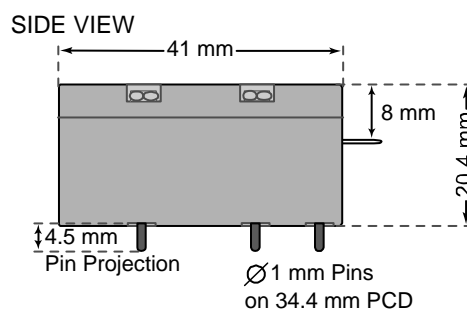
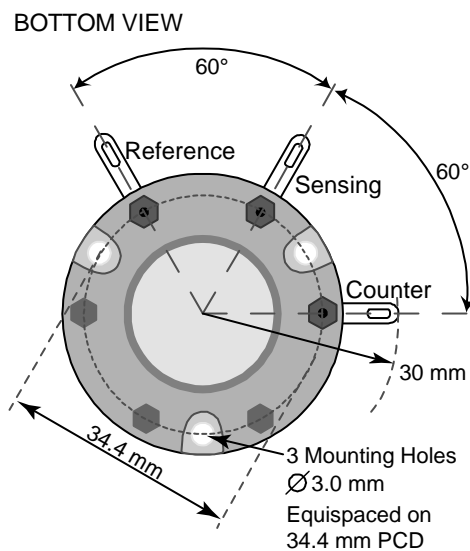
Standard-Size Outline Dimensions

The data contained in this document is for guidance only. Membrapor AG accepts no liability for any consequential losses, injury or damage resulting from the use of this document or the information contained within it. The data is given for guidance only. Customers should test under their own conditions, to ensure that the sensors are suitable for their own requirements.

REV.: 6/2010

Page 1 of 1

Phone: +41 43 311 72 00
Fax : +41 43 311 72 01
Email: info@membrapor.ch
www.membrapor.ch

MEMBRAPOR AG
Birkenweg 2
CH-8304 Wallisellen
Switzerland

SUNSTAR自动化 <http://www.sensor-ic.com/> TEL: 0755-83376489 FAX:0755-83376182 E-MAIL: szss20@163.com