

Interactive Catalog Supplements Catalog PDFs

If you need detailed product information, or help choosing the right product for your application, see our **Interactive Catalog**. Use the **Interactive Catalog** to access the most complete and up-to-date information available.

The **Interactive Catalog** provides an extensive collection of product specifications, application data, and technical literature that can be searched based on criteria you select.

This PDF catalog information was published in November 2000.



Sensing and Control
**Interactive
Catalog...**

**Click this icon to try
the Interactive Catalog.**

Sensing and Control

Honeywell Inc.

11 West Spring Street

Freeport, IL 61032



Position Sensors

FW Series

Severe Environmental Proximity Sensors

MICRO SWITCH FW severe environment proximity sensors are designed for use in harsh environments - aircraft, ordnance, marine, mass transit, etc. They are well suited to applications with particularly demanding requirements on temperature, vibration, shock, and EMI/lightning resistance.

Because of the nearly infinite combination of "special" requirements imposed by the different applications, it is impossible to list all products in a catalog. Many FW sensors have been custom-designed to fit the needs of a specific customer. For example, FW sensors have been designed to operate directly in high-pressure hydraulic systems; to work without performance degradation in high radiation environment; and to count projectiles at rates of 4000/minute in the high-shock, high vibration environment of a "Gatling" gun.

The development of these demanding designs has given MICRO SWITCH a wealth of applications engineering expertise, with years of experience in aviation and related proximity position sensing. The FW sensors shown in this catalog are examples only, to demonstrate capability and variety. MICRO SWITCH field engineers will be glad to work with customers, to define their unique requirements and arrive at a design particularly suited to those needs.

These sensors come in two distinct packaging concepts. One-piece, as the name implies, contain the sensing element and the associated conditioning electronics in a single package. Two-piece devices have only a passive sensing element in the sensing package, with remote electronics packaged separately, allowing location of the sensitive electronic components in a more sheltered environment, up to 250 feet away from the sensor.

MICRO SWITCH manufactures one-piece proximity sensors in two different technologies - Eddy Current Killed Oscillator or ECKO (our 100FW series) and Hall Effect (200FW series). The two-piece, 300/400FW series are balanced bridge, variable inductance devices.

Each of these technologies has unique features, and choice of technology must be based on application needs. The features chart below addresses some of the major points.

	100FW	200FW	300/400FW
Technology	ECKO	Hall	Variable inductance
EMI resistance	Moderate	Moderate	High
Target material	All metals	Magnet	Ferrous metals
Reliability	High	High	Very high
Temperature extremes	-55 +125°C	-55 +100°C	-70 +125 / -40 +85°C
Speed/response time	Moderate	High	Low
Built-in test	Limited	Limited	Full

Position Sensors

Position Sensors

100FW Series

Severe Environment Proximity Sensors

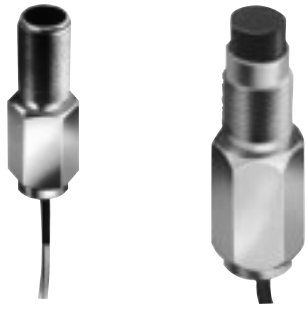

FEATURES

- All-metals sensitive
- Designed for aircraft, ordnance, marine, mass transit, high performance industrial equipment
- Stainless steel housing, thick wall construction for effective shielding
- Leadwire or connector termination
- Factory Mutual certified for Class I, Division 2, Groups A, B, C, D
- Circuit protection against:
 - Transients, MIL-STD-704
 - EMI, MIL-STD-461
 - False pulse
 - Load shorts
 - Reverse voltage
 - 400 Hz interference

100FW ORDER GUIDE

Sensor Package Style	Sensing Range mm (in.)	Repeatability, (max.)	Switching Frequency**	Standard Target* mm (in.)	Termination	Catalog Listing
5/8-24 UNEF	2,41mm ± 0,51 (.095 ± .02) Shielded	± 1%	500 Hz	15,9 dia. x 1,59mm (.625 dia. x .062) (SAE 1018 steel)	Connector	112FW12-R1
					Leadwire	112FW12-4
5/8-24 UNEF	5,84mm ± 0,76 (.230 ± .03) Unshielded	± 1%	500 Hz	15,9 dia. x 1,59mm (.625 dia. x .062) (SAE 1018 steel)	Connector	
					Leadwire	122FW12-4

* For any given set of environmental conditions. Note: for most aerospace applications, repeatability is not specified; all variations, including repeatability, environmental effects and manufacturer's tolerances are included in the basic tolerance of operating parameters.
 ** Varies with application details (target size, distance, etc.); should be evaluated for each installation design.

MOUNTING DIMENSIONS

For reference only

mm
in.

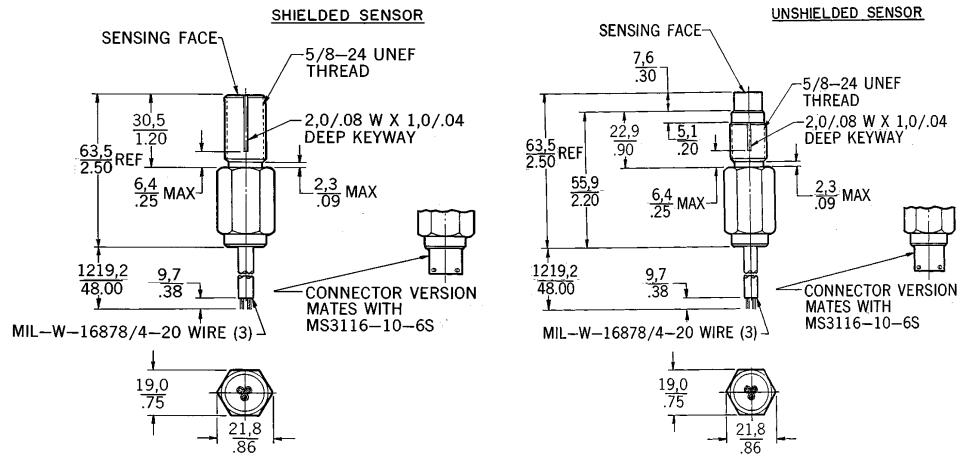

ELECTRICAL SPECIFICATIONS

Supply Voltage (Vs)	18-32 VDC
Leakage Current	10 μA
Voltage Drop, max.	1.0 V
Current Consumption, max. (exclusive of load)	20 mA
Load Current, max.	120 mA, 50 mA Lamp
Hysteresis	0,13mm (.005)
Circuit Protection	Transients, MIL-STD-704 False pulse Load shorts EMI, MIL-STD-461A Reverse voltage 400 Hz interference

Position Sensors

200FW Series

Severe Environment Proximity Sensors



FEATURES

- Hall effect, magnetic field sensitive
- Designed for aircraft, ordnance, marine, mass transit, high performance industrial equipment
- Stainless steel housing, thick wall construction for effective shielding
- Leadwire or connector termination
- Factory Mutual approved for Class I, Division 2, Groups A, B, C, D
- Circuit protection against:
 - Transients, MIL-STD-704
 - False pulse
 - Reverse voltage
 - 400 Hz interference

200FW ORDER GUIDE

Sensor Package Style	Sensing Range mm (in.)	Repeatability, (max.)	Switching Frequency	Operate/Release Gauss, max.	Output	Termination	Catalog Listing
5/8-24 UNEF Shielded	2,4 to 11,4mm (.095 to .450)*	± 1%	1.5 kHz	550 max. 125 min.	N.O.	Connector	212FW10-R
					N.O.	Leadwire	212FW10-4
					N.C.	Leadwire	211FW10-4

* With 101MG7 magnet, available from MICRO SWITCH. Characteristics can be varied by using different magnets as actuators.

MOUNTING DIMENSIONS

For reference only

mm
in.

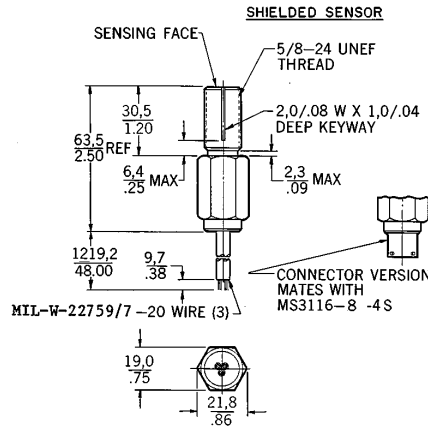

ELECTRICAL SPECIFICATIONS

Supply Voltage (Vs)	18-32 VDC
Leakage Current	10 μ A
Voltage Drop, max.	0.4 V
Current Consumption, max. (exclusive of load)	25 mA
Load Current, max.	100 mA, 50 mA Lamp
Hysteresis, max.	175 Gauss
Circuit Protection	Transients, MIL-STD-704 False pulse Reverse voltage 400 Hz interference

ENVIRONMENTAL SPECIFICATIONS

	100FW	200FW
Temperature Range	-54 to 125°C (-65 to 257°F)	-54 to 100°C (-65 to 212°F)
Materials		
Sensing Face	High temperature phenolic	Stainless steel
Housing	Stainless steel	Stainless steel

Position Sensors

Position Sensors

Aircraft Proximity Controls

300/400 FW Series

FEATURES

- Ferrous metals sensitive
- Two-piece construction — stainless steel bushing or flange mount sensors and plug-in electronics card
- Designed for aircraft, inboard or out-board
- Withstands temperature extremes and exposure to salt, humidity, sand, dust, and corrosive fluids such as skydrol
- Sensitive electronics on plug-in card for inside mounting
- Circuit protection against: Transients, MIL-STD-704 EMC, MIL-STD-461, 462 Reverse polarity (input protected)

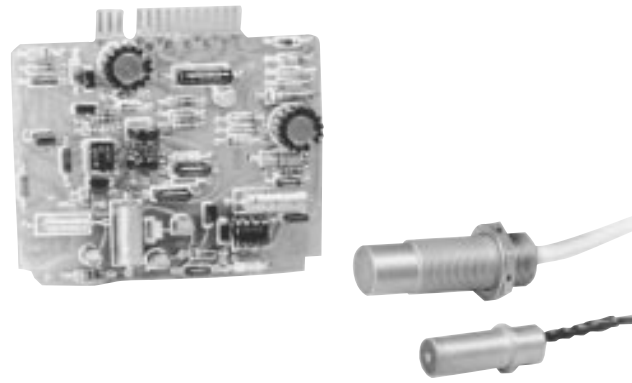

300/400 FW ORDER GUIDE

Sensor Size	Sensing Distance mm (in.)	Hysteresis mm (in.)	Output	Catalog Listings
11,2mm (.44 in.) Shielded	1,40-1,78mm (.055-.070)*	0,13-0,25mm* (.005-.010)	Current Sinking, N.O./N.C.	330FW04A-1
5/8-24 UNEF Thread Shielded	1,78-3,30mm (0.70-.130)**	0,13-0,76mm** (.005-.030)		390FW04A-10
Plug-in Electronic Card				405FW504-B

* When operated by a Carpenter HI-MU 80 slug, and installed in 303 stainless steel housing

** When operated by a 15-SPH steel target, 15,88mm (.625 in.) x 1,57mm (.062 in.)

MOUNTING DIMENSIONS (For reference only)

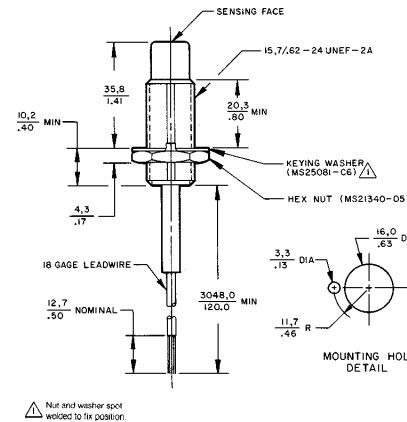
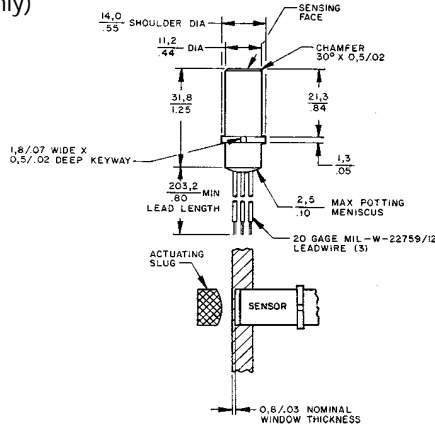
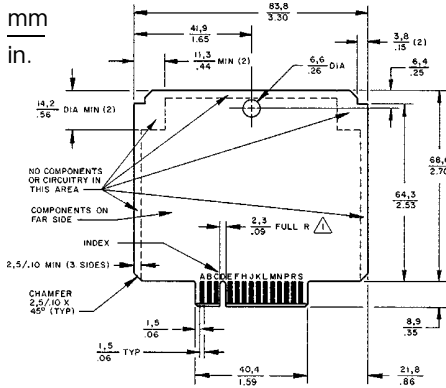

405FW504-B CARD 83,8x68,6mm (3.30x2.70 in.)

ELECTRICAL SPECIFICATIONS

Supply Voltage (Vs)	18-32 VDC, MIL-STD-704
Supply Current	65 mA max.
Load Current, max.	750 mA, ind. or res.
Circuit Protection	Reverse polarity (input protected) Transients, MIL-STD-704 Electromagnetic compatibility (EMC), MIL-STD-461, 462
Termination	
330FW04A-1 Sensor	Three 20 gage wires, per MIL-W-22759/12
390FW04A-10 Sensor	Three twisted 18 gage wires
405FW504-B Card	Mates with AMP 582553-1 connector or equivalent

ENVIRONMENTAL SPECIFICATIONS

Temperature Range	330FW04A-1 -77 to 120°C (-107 to 248°F)	390FW04A-10 -77 to 125°C (-107 to 257°F)
Shock	MIL-STD-810B, Method 516: 100G, 1 millisecond	
Vibration	25G peak, sinusoidal	
Humidity	MIL-STD-810B, 95% RH @ 65°C	
Altitude	Sea level to 70,000 feet	
Chemicals	Resistant to skydrol and typical aircraft fuels	
Circuit Card		
Temperature Range	-40 to 80°C (-40 to 176°F)	
Vibration	5G peak, sinusoidal	
Humidity	MIL-STD-810B, 95% RH @ 65°C	
Altitude	Sea level to 70,000 feet	