

EE36

Transmitters for Moisture Content in Oil

E+E Transmitter Series EE36 are specially designed for the measurement of water content in oil. They are certified in accordance with the regulations of the "Germanischen Lloyd (GL)" and therefore can be utilized in the maritime field as well. The Series EE36 is ideal for online monitoring of moisture in lubrication or insulation oil, which is very important for the long-term performance and adaptive maintenance of plant and machinery. For instance, moisture affects dramatically the insulation characteristics of electrical transformer oil and therefore continuous monitoring is extremely important.

Humidity measurement in oil

Similar to the humidity in the air, the water content in an oil can be described by the absolute value in ppm or by the relative value a_w :

- ppm (mass of water / mass of oil)
- a_w (actual water content as fraction of the water content in the saturated oil)

$a_w = 0$ corresponds to water-free oil, while $a_w = 1$ describes fully saturated oil. a_w measurement with EE36 transmitter series is based on the outstanding long term stability and resistance to pollution of the E+E capacitive sensor elements series HC.

Product Versions

The physical quantities measured are water activity a_w and temperature T . With these quantities EE36 calculates the water content (ppm) in mineral transformer oils. Calculation of water content in non-mineral transformer oils and lubrication oils can be accomplished by inputting specific parameters of the oil.

The measured and the calculated values are available on two free scalable and configurable analogue outputs. In addition, an optional relay output can be used for alarms and process control.

Installation

The sensing probe is designed for inline monitoring and can be placed directly in the oil, at pressures up to 20bar (300psi). In addition to direct mounting of the sensing probe, a ball valve installation provides mounting and removal of the probe without interrupting the process.

Easy Calibration and Adjustment of EE36

The user can easily readjust or calibrate the transmitter by using either a simple procedure with two push buttons on the printed circuit board or the configuration software.



Software Tools

The configuration software is included in the scope of supply and allows an easy and fast configuration of the analogue outputs and of the alarm and control thresholds. Further features of the configuration software are adjustment and calibration of the outputs and service operations such as replacement of the sensing elements or of the entire sensing probe.

Features of EE36

Measurement of a_w and T at pressure up to 20bar (300psi)	✓
Calculation of water content in ppm for mineral transformer oil	✓
Two free saleable and configurable analogue outputs	✓
Probe cable length up to 20m (66ft)	✓
Easy on site adjustment and calibration of a_w and T outputs	✓
LED indication for operation and sensing probe status	✓
User configuration of the instrument with PC via RS232 interface	✓
Configuration software	✓
Display of a_w , T and water content with MIN/MAX function	optional
Two free configurable relays outputs	optional
Pluggable sensing probe	optional
Connector for power supply and outputs	optional

Integrated power supply

A power supply, integrated in the back module of the housing, can be ordered optionally (100...240V AC, 50/60Hz; ordering code V01). The power supply V01 is available for both polycarbonate and metal housing and comes standard with two plugs for supply and outputs to allow an easy connection.



Housing Dimensions (mm)

Housing:

polycarbonate housing

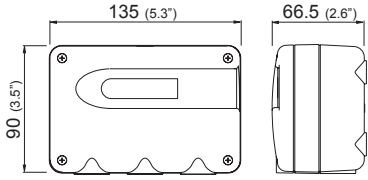

metal housing

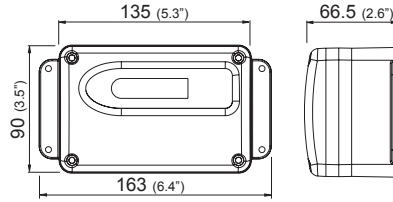

For use in harsh industrial environments the EE36 series is available in a robust metal housing.

Model:

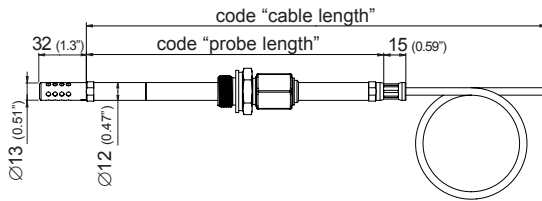

EE36-xEx

Remote probe for T -40...180°C (-40...356°F)
and pressure-tight up to 20bar (300psi)
probe material: stainless steel

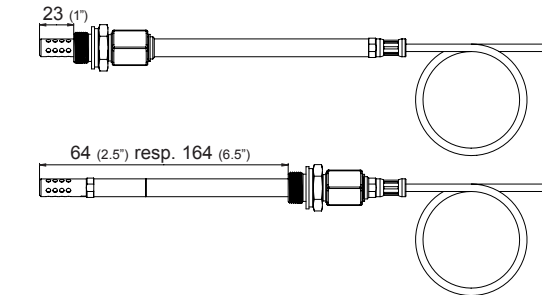

minimum installation depth

maximum installation depth

Installation Example

ball valve installation
(pressure-tight up to 20bar/290psi)

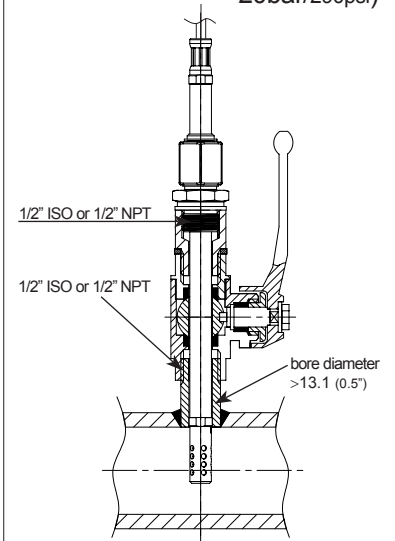

fixed installation
(pressure-tight up to 20bar/300psi)

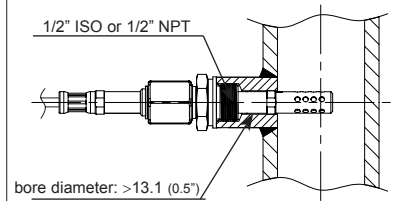

Connection Versions

Standard

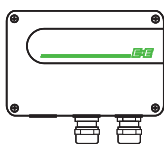

2x M16x1.5

Plug Option C03

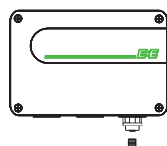

Lumberg
RKC 5/7

power supply +
analogue output

Plug Option C06

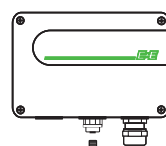

Lumberg
RSC 5/7 M16x1.5

Plug Option C07

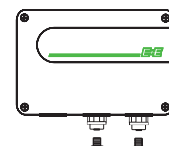

Lumberg
RSC 5/7 RS232 Lumberg
RKC 5/7

power supply +
analogue output

Connection Diagram

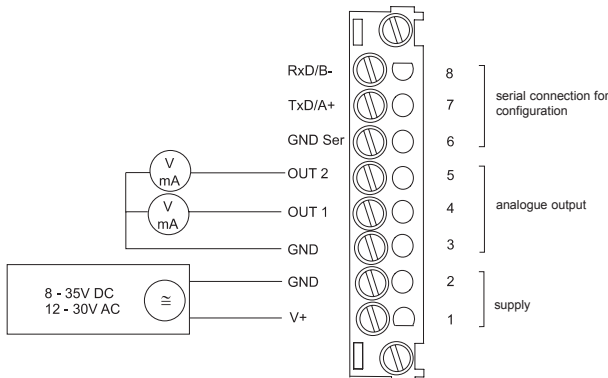

Terminal configuration - Alarm output

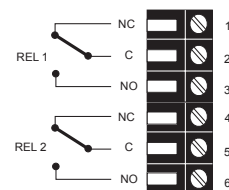

Technical Data

Measuring values

Water activity

Water activity sensor ¹⁾	HC1000-400	
Measuring range ¹⁾	0...1 a _w	
Accuracy ²⁾ (including hysteresis, non-linearity and repeatability, traceable to intern. standards, administrated by NIST, PTB, BEV...)		
-15...40°C (5...104°F)	≤0.9 a _w	± (0.013 + 0.3%*mv) a _w
-15...40°C (5...104°F)	>0.9 a _w	± 0.023 a _w
-25...70°C (-13...158°F)		± (0.014 + 1%*mv) a _w
-40...180°C (-40...356°F)		± (0.015 + 1.5%*mv) a _w
Temperature dependence of electronics	typ. ± 0.0001 [1/°C]	(typ. ± 5.6 * 10 ⁻⁵ [1/°F])
Temperature dependence of sensing probe	typ. ± (0.00002 + 0.0002 x a _w) x ΔT [°C] ΔT = T - 20°C	
Response time with stainless steel filter at 20°C / t ₉₀	typ. 10min in still oil	

Temperature

Temperatur sensor element	Pt1000 (tolerance class A, DIN EN 60751)
Working range sensing probe	-40...180°C (-40...356°F)
Accuracy	

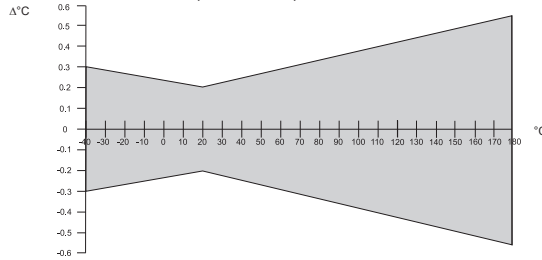

Temperature dependence of electronics	typ. ± 0.005°C/°C
---------------------------------------	-------------------



Outputs²⁾

Two freely selectable and scaleable analogue outputs	0 - 5V	-1mA < I _L < 1mA
	0 - 10V	-1mA < I _L < 1mA
	4 - 20mA	R _L < 500 Ohm
	0 - 20mA	R _L < 500 Ohm

Adjustable measurement range²⁾

	from	up to	units
Water activity a _w	0	1	
Temperature T	-40 (-40)	180 (356)	°C (°F)
Water content ³⁾ x	0	100 000	ppm

General

Supply voltage	8...35V DC 12...30V AC	(optional 100...240V AC, 50/60Hz)
Current consumption - 2x voltage output	for 24V DC/AC: typ. 40mA	
- 2x current output	typ. 80mA	
Pressure range sensing probe	0.01...20bar (0.15...300psi)	
System requirements for software	WINDOWS 2000 or later; serial interface	
Serial interface for configuration ⁴⁾	RS232C	
Housing / Protection class	PC or AI Si 9 Cu 3 / IP65; Nema 4	
Cable gland	M16 x 1.5 cable Ø 4.5 - 10 mm (0.18 - 0.39")	
Electrical connection	screw terminals up to max. 1.5mm ² (AWG 16)	
Sensor protection	stainless steel filter	
Operating temperature range of electronics	-40...60°C (-40...140°F)	
Working and storage temperature range		
Housing with display	-20...50°C (-4...122°F)	
Storage temperature	-40...60°C (-40...140°F)	
Electromagnetic compatibility according to	EN61326-1 EN61326-2-3	ICES-003 ClassB FCC Part15 ClassB
GL-Certification ⁵⁾	Industrial Environment Environmental Category D	 

Options

Display	graphical LCD (128x32 pixels), with integrated push-buttons for selecting parameters and MIN/MAX function
Alarm outputs	2 x 1 switch contact: 250V AC / 6A and 28V DC / 6A threshold + hysteresis can be adjusted with configuration software
Switching parameters (freely selectable)	a _w Water activity T Temperature x Water content

1) refer to the working range of the humidity sensor.

2) can be easily changed by software

3) ppm output is valid in the range 0...100°C (32...212°F)

4) no data output

5) not for polycarbonate housing or integrated power supply (V01)

*) The accuracy statement includes the uncertainty of the factory calibration with an enhancement factor k=2 (2-times standard deviation). The accuracy was calculated in accordance with EA-4/02 and with regard to GUM (Guide to the Expression of Uncertainty in Measurement).

Ordering Guide

Hardware Configuration		EE36-
Housing	metal housing	M
	polycarbonate housing ¹⁾	P
Type	pressure tight	E
Cable length (incl. probe length)	1m (3.3ft)	01
	2m (6.6ft)	02
	5m (16.4ft)	05
	10m (32.8ft)	10
	20m (65.6ft)	20
	Probe length	100mm (3.9") 200mm (7.9")
Pressure-tight feedthrough	1/2" male thread	HA03
	1/2" NPT thread	HA07
Display	without display	
	with display	D05
Alarm output ²⁾	without relay	
	with relay	SW
Plug	cable thread	
	1 plug for power supply and output	C03
	1 cable thread / 1 plug for RS232	C06
	2 plugs for power supply/outputs and RS232	C07
Sensing probe	fixed pluggable	P01
Supply	8...35V DC / 12...30V AC	
	integrated power supply 100...240V AC, 50/60Hz ¹⁾³⁾	V01

Software Configuration						
Physical parameters outputs	Temperature	T	[°C / °F]	(B)	output 1	
	Water activity	aw	[]	(K)		
	Water content in mineral transformer oil	x	[ppm]	(L)	output 2	
	Water content in lubrication or non-mineral transformer oil ⁴⁾	x	[ppm]	(M)		
Type of output signals	0-5V			(2)		
	0-10V			(3)		
	0-20mA			(5)		
	4-20mA			(6)		
Temperature unit	°C					
	°F					
T-Scaling	-40...60	(T02)	-20...100	(T14)	-40...140	(T83)
	0...50	(T04)	0...120	(T16)	0...250	(T88)
	0...100	(T05)	0...80	(T21)	32...120	(T90)
	-30...70	(T08)	-20...80	(T24)	32...140	(T91)
	-20...120	(T10)	-40...160	(T33)	32...250	(T94)
	-40...120	(T12)	-40...250	(T81)	32...132	(T96)
	0...100ppm	(X01)	0...1000ppm	(X03)		
	0...500ppm	(X02)	0...10000ppm	(X04)		
					output T	
					output x	

1) No GL-Certification

2) Combination alarm output and plugs is not possible (with cable glands only) / combination alarm output and integrated power supply is not possible

3) Integrated power supply includes 2 plugs for power supply and outputs / further plug options are not possible

4) Input of oil specific parameters necessary

Accessories / Replacement Parts

(For further information see data sheet "Accessories")

- Stainless steel filter for EE36	(HA010110)	- Calibration set	(HA0104xx)
- Display + housing cover in metal	(D05M)	- Interface cable for PCB	(HA010304)
- Display + housing cover in polycarbonate	(D05P)	- Interface cable for plug C06, C07	(HA010311)
- Replacement probe	(PExxxx)**	- Ball valve set 1/2" ISO	(HA050101)
- Humidity sensor	(FE09)	- Ball valve set 1/2" NPT	(HA050104)
- Bracket for installation onto mounting rails*	(HA010203)	- Double nibble G1/2" to G3/4"	(HA011107)
- Sealing element	(HA050308)	- Enlargement G1/2" to G3/4"	(HA011106)

*Note: Only for plastic housing, not for metal housing

**Only for Version P01 available

Order Example

EE36-PE055HA03D05P01/BL3-T08-X01

Housing:	polycarbonate housing
Type:	pressure tight
Cable length:	5m (16.4ft)
Probe length:	200mm (7.9")
Pressure-tight feedthrough:	1/2" male thread
Display:	with display
Alarm output:	without relay
Plug:	1 plug for power supply and output
Sensing probe:	pluggable
Supply voltage:	8...35V DC / 12...30V AC

Output 1:	T
Output 2:	x (mineral transformer oil)
Output Signal:	0-10V
Temperature unit:	°C
Scaling of T-output:	-30...70°C
Water content x:	0...100ppm