



# LITE-ON TECHNOLOGY CORPORATION

Property of LITE-ON Only

## FEATURES

- \* NON-CONTACT SWITCHING.
- \* FOR DIRECT PC BOARD OR DUAL-IN-LINE SOCKET MOUNTING.
- \* FAST SWITCHING SPEED.

## PACKAGE DIMENSIONS

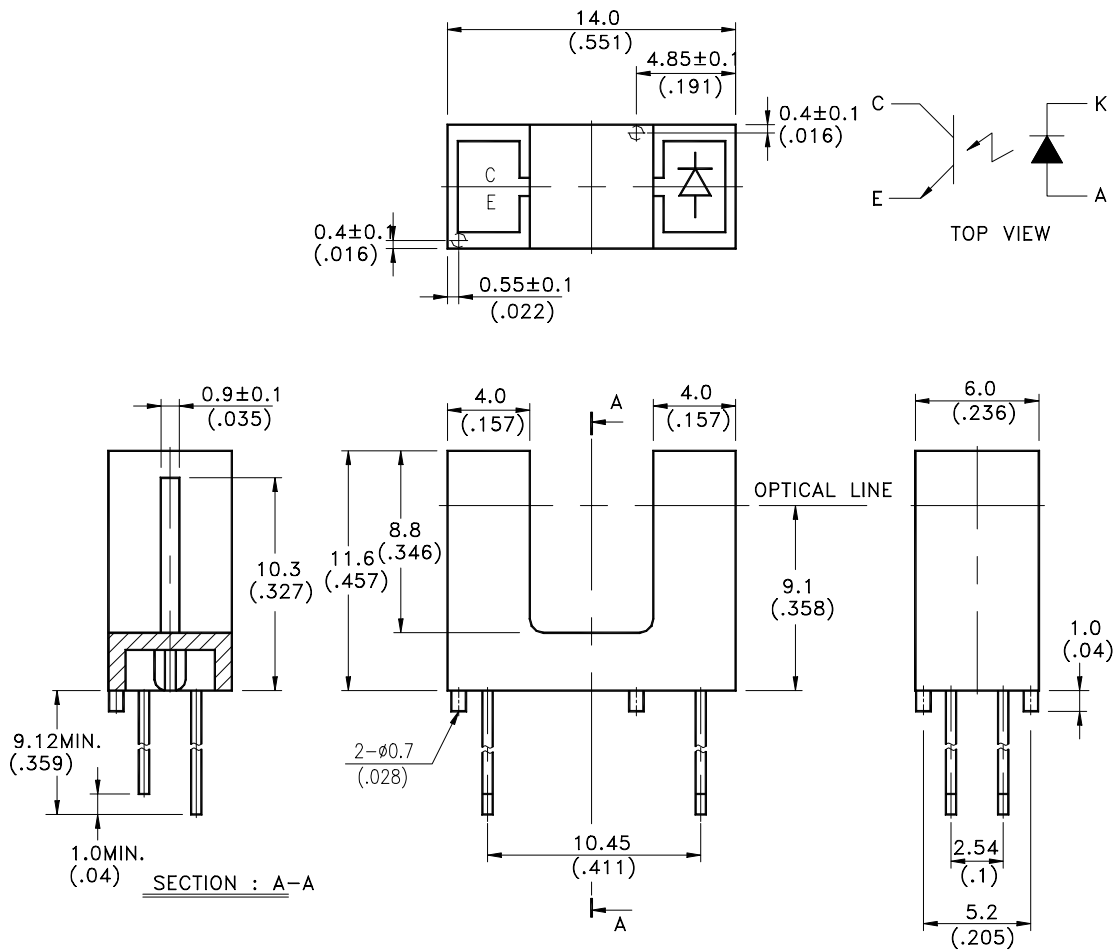

## NOTES:

1. All dimensions are in millimeters (inches).
2. Tolerance is ±0.25mm(.010") unless otherwise noted.

**LITEON** LITE-ON TECHNOLOGY CORPORATION

Property of Lite-On Only

**ABSOLUTE MAXIMUM RATINGS AT T<sub>A</sub>=25**

PARAMETER	MAXIMUM RATING	UNIT
IR Diode Continuous Forward Current	60	mA
IR Diode Reverse Voltage	5	V
Transistor Collector Current	20	mA
Transistor Power Dissipation	75	mW
IR Diode Peak Forward Current (Pulse Wide = 10 $\mu$ S, 300 pps)	1	A
Diode Power Dissipation	100	mW
Phototransistor Collector-Emitter Voltage	30	V
Phototransistor Emitter-Collector Voltage	5	V
Operating Temperature Range	-25 to + 85	
Storage Temperature Range	-40 to + 100	
Lead Soldering Temperature [1.6mm(.063") From Case]	260 for 5 Seconds	

**LITEON** LITE-ON TECHNOLOGY CORPORATION

Property of Lite-On Only

**ELECTRICAL OPTICAL CHARACTERISTICS AT TA=25**

PARAMETER	SYMBOL	MIN.	TYP.	MAX.	UNIT	TEST CONDITION
<b>INPUT LED</b>						
Forward Voltage	V <sub>F</sub>		1.2	1.6	V	I <sub>F</sub> = 20mA
Reverse Current	I <sub>R</sub>			100	μA	V <sub>R</sub> =5V
<b>OUTPUT PHOTOTRANSISTOR</b>						
Collector-Emitter Breakdown Voltage	V(BR) <sub>CEO</sub>	30			V	I <sub>C</sub> =1mA
Emitter-Collector Breakdown Voltage	V(BR) <sub>ECO</sub>	5			V	I <sub>E</sub> =100 μA
Collector-Emitter Dark Current	I <sub>CEO</sub>			100	nA	V <sub>CE</sub> =10V
<b>COUPLER</b>						
Collector-Emitter Saturation Voltage	V <sub>CE(SAT)</sub>			0.4	V	I <sub>C</sub> =0.25mA I <sub>F</sub> =20mA
On State Collector Current	I <sub>c(ON)</sub>	0.5			mA	V <sub>CE</sub> =5V I <sub>F</sub> =20mA
Response Time	Rise Time	t <sub>r</sub>	3	15	μS	V <sub>CE</sub> =5V, I <sub>c</sub> =2mA R <sub>L</sub> =100Ω
	Fall Time	t <sub>f</sub>	4	20		

# LITEON LITE-ON TECHNOLOGY CORPORATION

Property of Lite-On Only

## TYPICAL ELECTRICAL / OPTICAL CHARACTERISTICS CURVES

(25 Ambient Temperature Unless Otherwise Noted)

Fig.1 Power Dissipation vs. Ambient Temperature

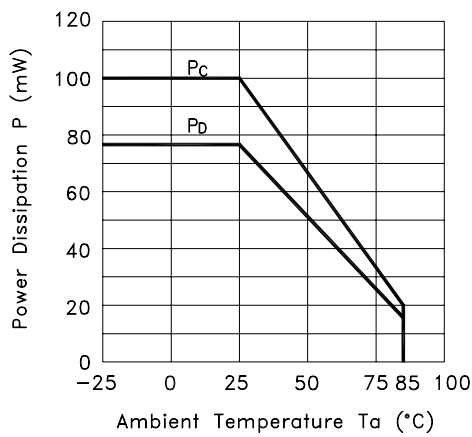

Fig.2 Forward Current vs. Forward Voltage

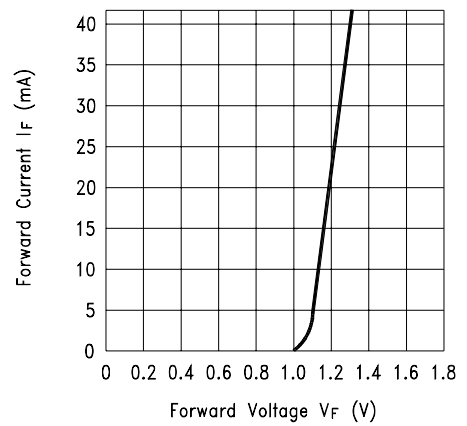

Fig.3 Collector Current vs. Collector-emitter Voltage

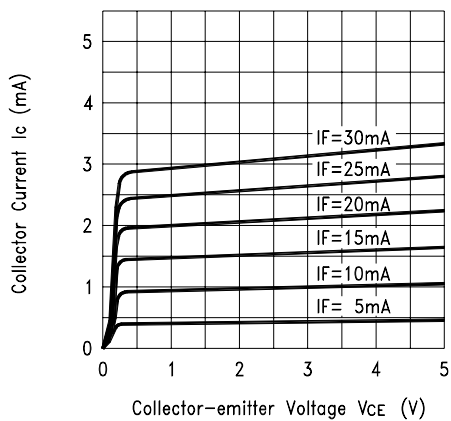
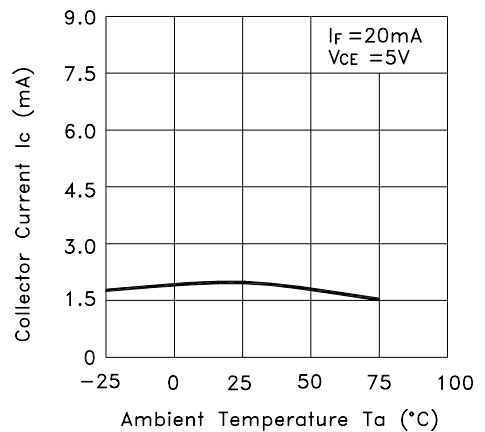

Fig.4 Collector Current vs. Ambient Temperature



# LITEON LITE-ON TECHNOLOGY CORPORATION

Property of Lite-On Only

## TYPICAL ELECTRICAL / OPTICAL CHARACTERISTICS CURVES

(25 Ambient Temperature Unless Otherwise Noted)

Fig.5 Collector-emitter Saturation Voltage vs. Ambient Temperature

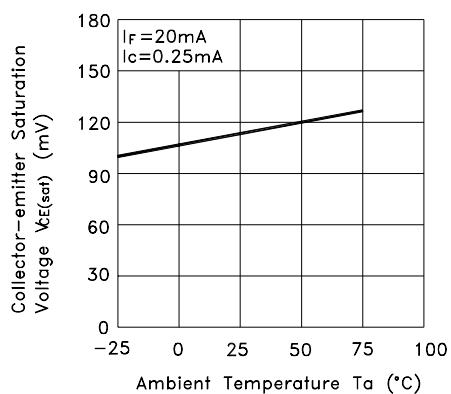
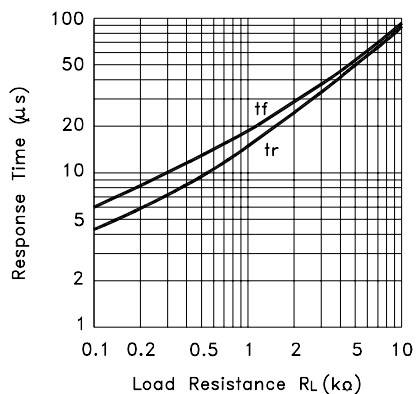

Fig.6 Response Time vs. Load Resistance



Test Circuit for Response Time

