

EE-SX1107/1108/1109/1131

Ultra-Compact Photomicrosensors with Surface-Mount Design

- Surface mount design, and tape and reel packaging facilitate automated PCB assembly
- Compact size makes these sensors ideal for use in applications with restricted space
- High-resolution sensing with phototransistor output
- Dual channel model that is ideal for encoder applications (EE-SX1131)

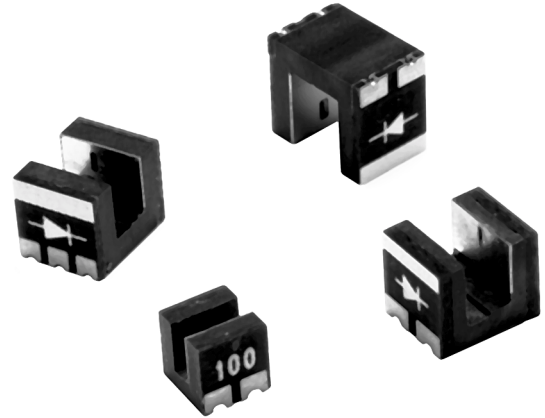

Ordering Information

Appearance	Sensing method	Slot width	Slot depth	Sensing object	Weight	Part number
	Transmissive	1 mm	2 mm	Opaque 0.15 x 0.6 mm min.	0.05 g	EE-SX1107
		2 mm	2.8 mm	Opaque 0.3 x 1.0 mm min.	0.1 g	EE-SX1108
		3 mm	3.5 mm	Opaque 0.5 x 1.0 mm min.	0.1 g	EE-SX1109
	Dual channel transmissive	2 mm	2.8 mm	Opaque 0.3 x 1.0 mm min.	0.1 g	EE-SX1131

Specifications

■ ABSOLUTE MAXIMUM RATING (T_A=25°C)

Item	Symbol	Rated value
Emitter	Forward current	I _F 25 mA (see note)
	Pulse forward current	I _{FP} 100 mA (duty: 1/100, pulse width: 0.1 ms)
	Reverse voltage	V _R 5 V
Detector	Collector-emitter voltage	V _{CEO} 20 V
	Emitter-collector voltage	V _{ECO} 5 V
	Collector current	I _C 20 mA
	Collector dissipation	P _C 75 mW (see note)
Ambient temperature	Operating	T _{opr} -30° to 85°C
	Storage	T _{stg} -40° to 90°C
	Soldering (manual)	T _{sol} 300°C (3 second max.)
	Soldering (reflow)	T _{sol} 240°C (10 second max)

Note: Refer to Engineering Data if the ambient temperature is not within the normal room temperature range.

■ CHARACTERISTICS (T_A=25°C)

Item	Symbol	Value	Condition
Emitter	Forward voltage	V _F 1.1 V typ., 1.3 V max.	I _F = 5 mA
	Reverse current	I _R 10 μA max.	V _R = 5 V
	Peak emission wavelength	λ _{p(L)} 940 nm typ.	I _F = 20 mA
Detector	Dark current	I _D 100 nA max.	V _{CE} = 10 V, 0 lx
	Peak spectral sensitivity wavelength	λ _{p(P)} 900 nm typ.	—
Combination	Light current (collector-current)	I _L 50 μA min., 150 μA typ., 500 μA max.	I _F = 5 mA, V _{CE} = 5 V
	Collector-emitter saturation voltage	V _{CE (sat)} 0.1 V typ., 0.4 V max.	I _F = 20 mA, I _L = 50 μA
	Rising time	t _r 10 μs typ. (see note)	V _{CC} = 5 V, R _L = 1KΩ
	Falling time	t _f 10 μs typ. (see note)	I _L = 100 μA

Note: The following figures show the rising time (t_r) and falling time (t_f).

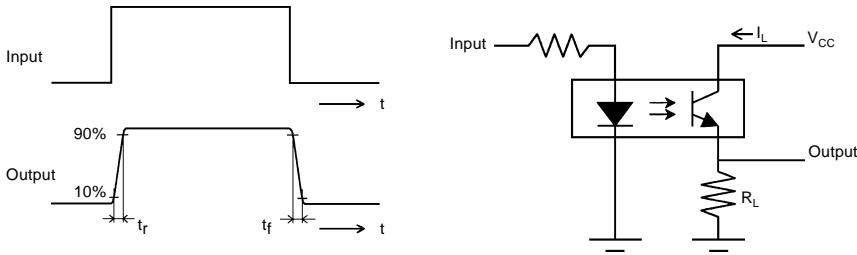

Engineering Data

Note: The operating conditions of the photomicrosensor must be within the absolute maximum rating ranges.

TEMPERATURE CHARACTERISTICS

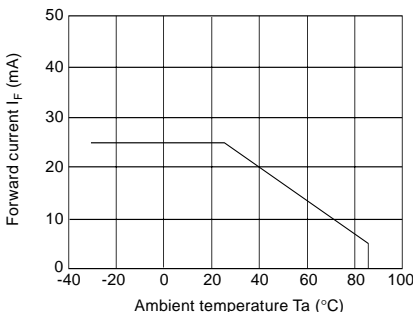
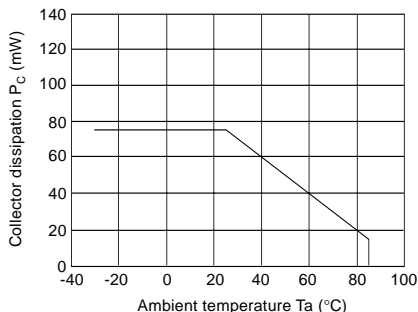

INPUT CHARACTERISTICS (TYPICAL)

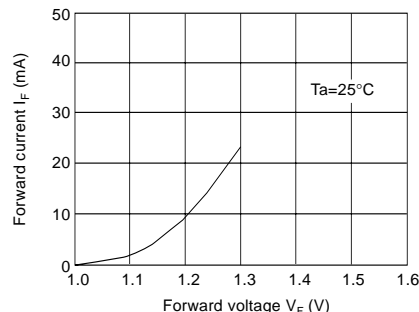

INPUT/OUTPUT CHARACTERISTICS (TYPICAL)

EE-SX1107

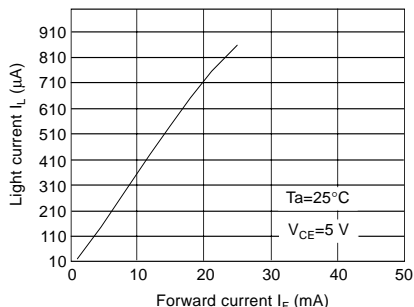

EE-SX1108/1131

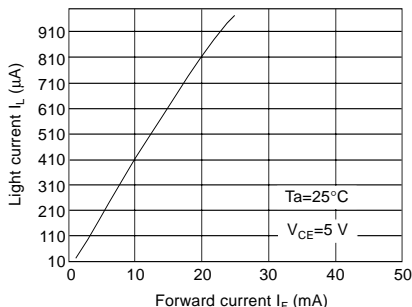

EE-SX1109

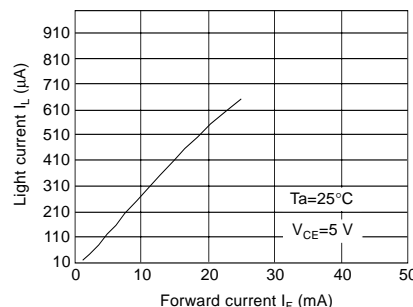

OUTPUT CHARACTERISTICS (TYPICAL)

EE-SX1107

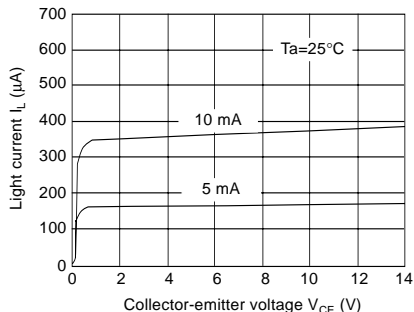

EE-SX1108/1131

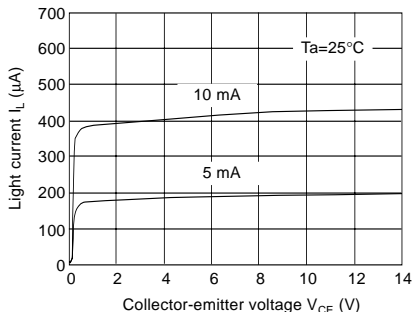

EE-SX1109

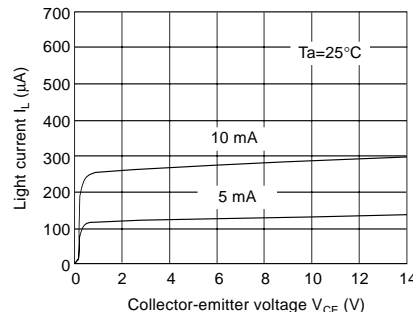

LIGHT CURRENT TEMPERATURE DEPENDENCY (TYPICAL)

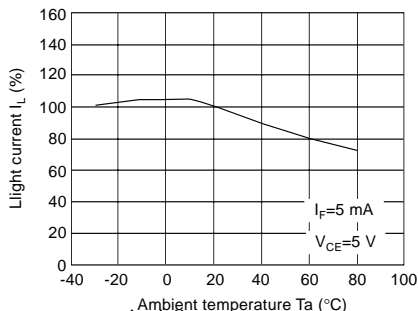

DARK CURRENT TEMPERATURE DEPENDENCY (TYPICAL)

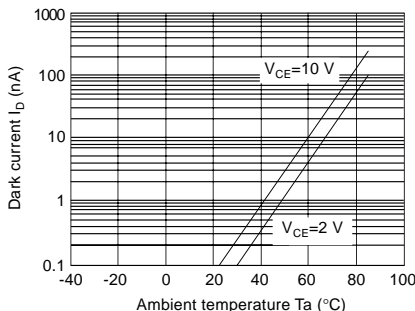

RESPONSE TIME CHARACTERISTICS (TYPICAL)

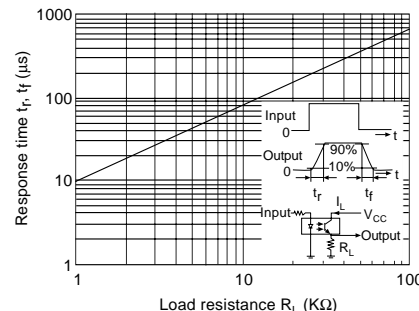

■ SENSING POSITION CHARACTERISTICS (TYPICAL)

EE-SX1107

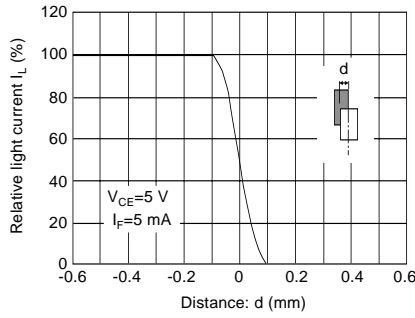
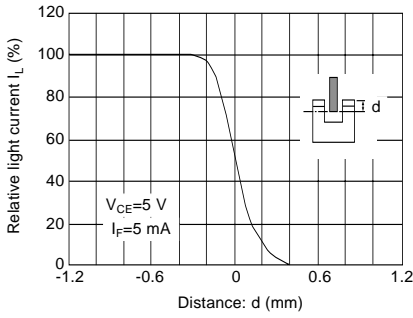

EE-SX1108/1109/1131

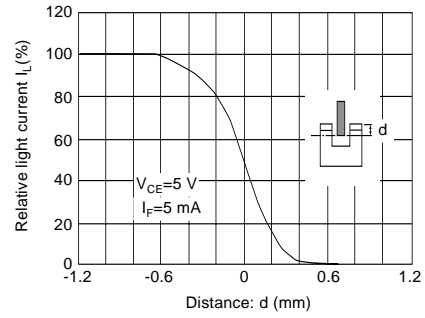

■ SENSING POSITION CHARACTERISTICS (TYPICAL)

EE-SX1108

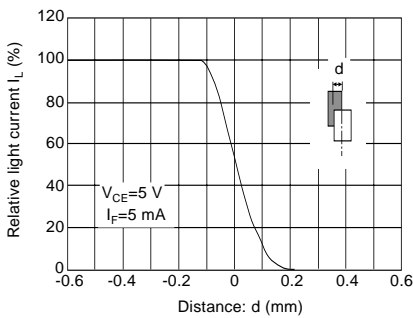

EE-SX1109

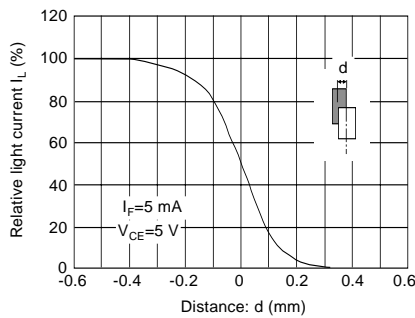

EE-SX1131

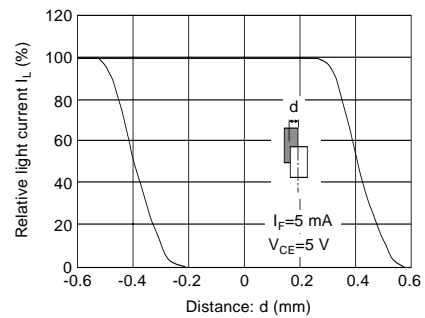

Dimensions

Unit: mm (inch)

■ EE-SX1107

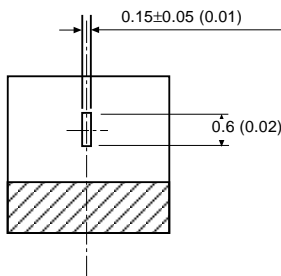
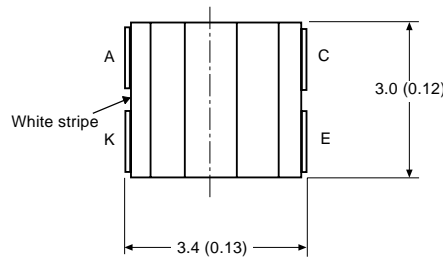

(Cross section AA view)

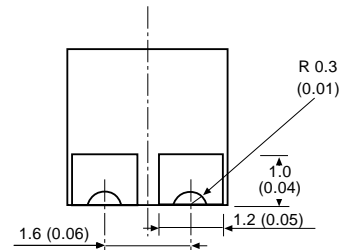
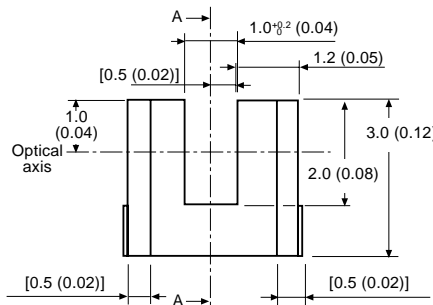

Note: 1. Unless otherwise specified, tolerances are ± 0.15 mm.
2. The values in brackets are relative dimensions.

Recommended soldering pattern

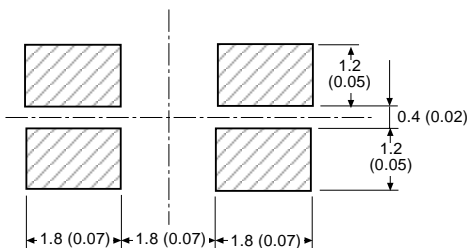

Pin assignment

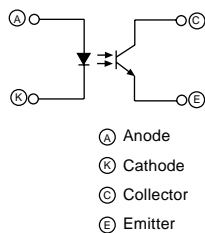

EE-SX1108

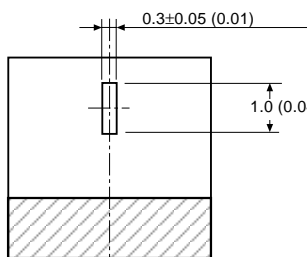
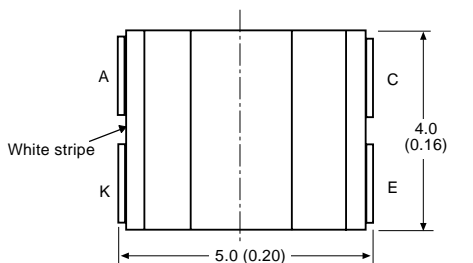

(Cross section AA view)

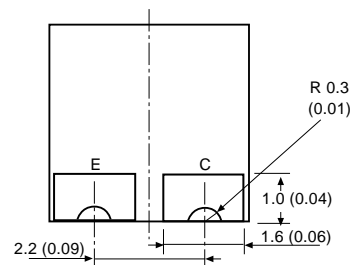
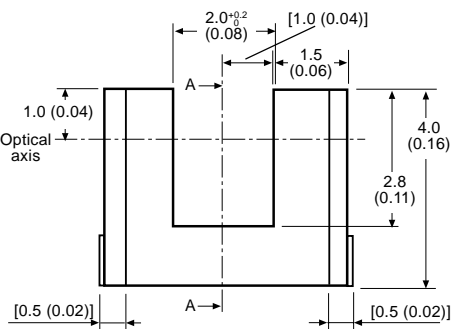

Recommended soldering pattern

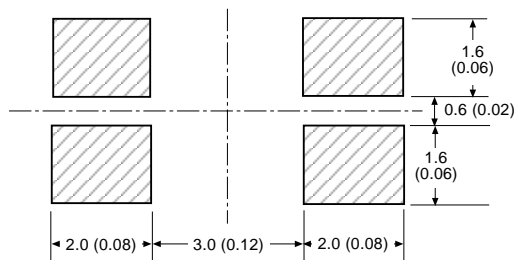

Pin assignment

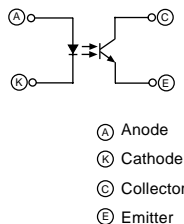

Note: 1. Unless otherwise specified, tolerances are ± 0.15 mm.
2. The values in brackets are relative dimensions.

Unit: mm (inch)

■ EE-SX1109

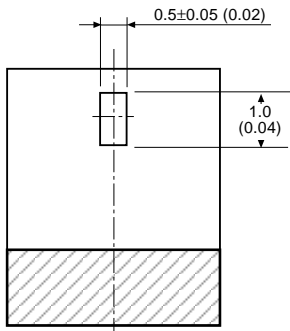
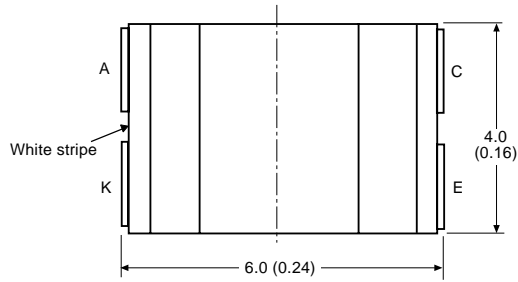

(Cross section AA view)

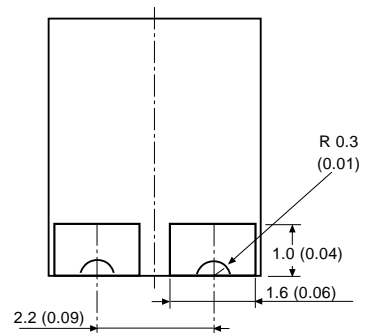
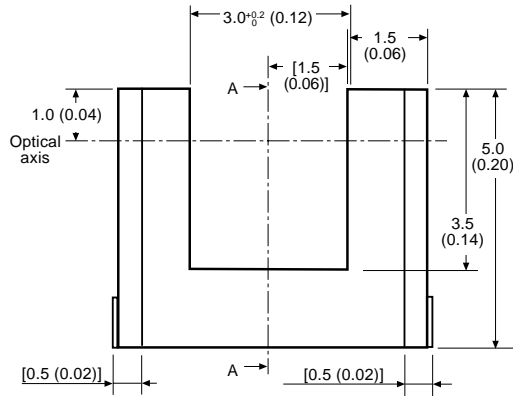

Recommended soldering pattern

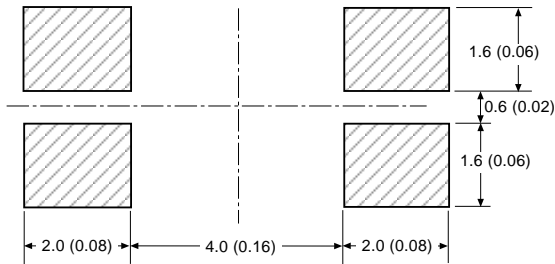

Pin assignment

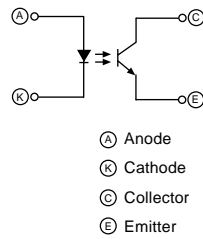

Note: 1. Unless otherwise specified, tolerances are ± 0.15 mm.
 2. The values in brackets are relative dimensions.

■ EE-SX1131

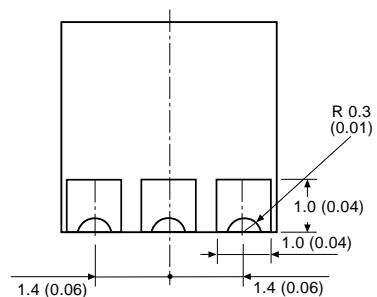
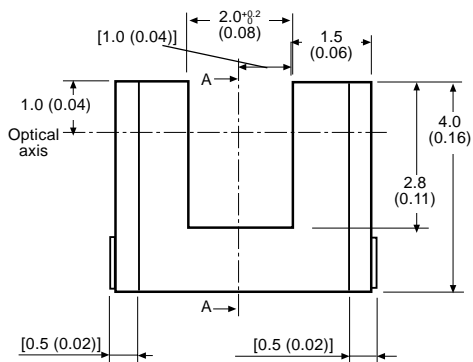
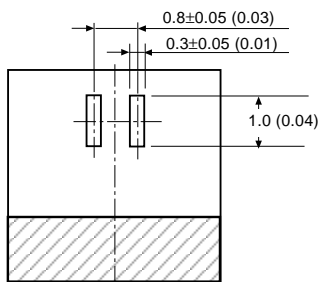
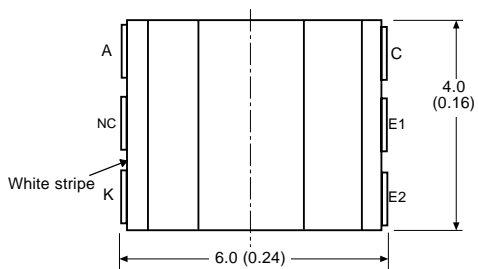
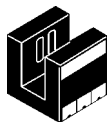

Recommended soldering pattern

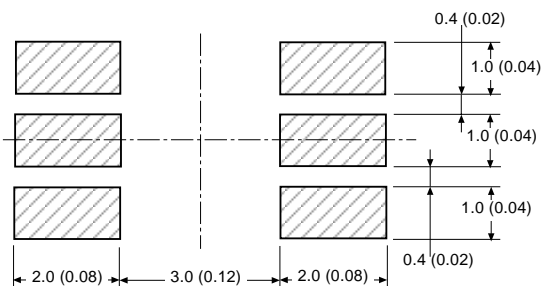

Pin assignment

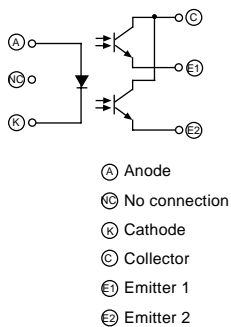

Note: 1. Unless otherwise specified, tolerances are ±0.15 mm.
2. The values in brackets are relative dimensions.

Unit: mm (inch)

■ TAPE AND REEL

Reel

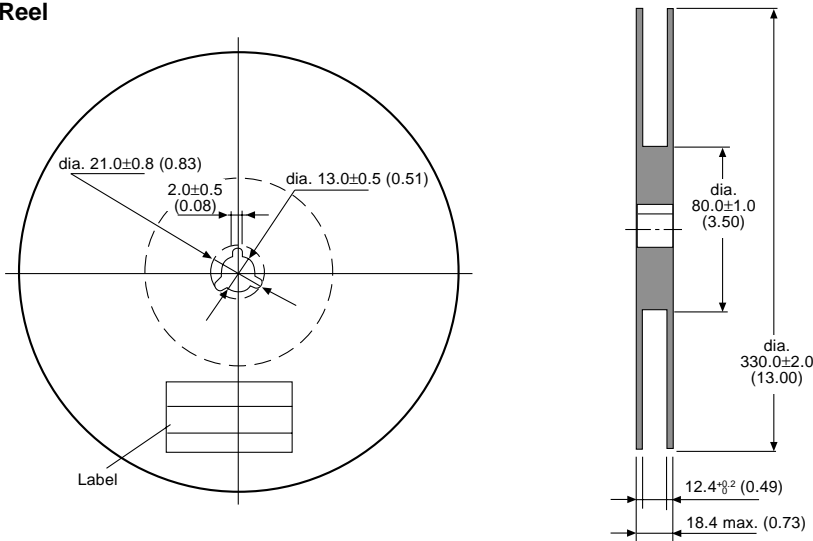

Tape

Figure 1

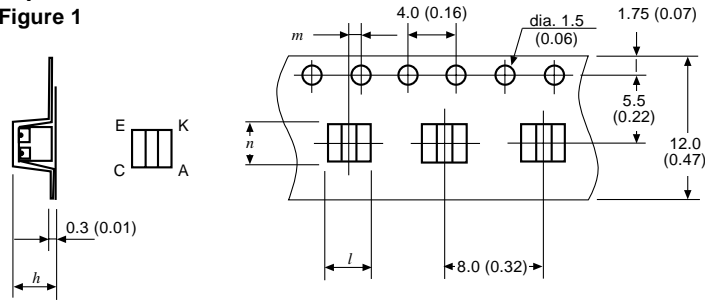

Part number	h	l	m	n
EE-SX1107	3.2 (0.13)	3.6 (0.14)	0.9 (0.04)	3.2 (0.13)
EE-SX1108	4.2 (0.17)	5.2 (0.20)	0.25 (0.01)	4.2 (0.17)
EE-SX1131	4.2 (0.17)	5.2 (0.20)	0.25 (0.01)	4.2 (0.17)

Figure 2

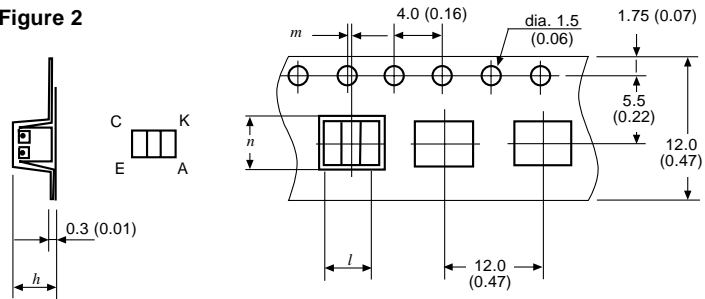

Part number	h	l	m	n
EE-SX1109	5.2 (0.20)	6.2 (0.24)	0.25 (0.01)	4.2 (0.17)

Tape configuration

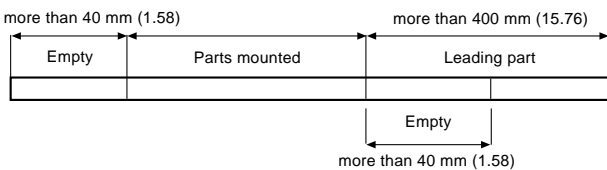

Quantity per reel

Part number	Pieces per reel
EE-SX1107	2500
EE-SX1108/EE-SX1131	2000
EE-SX1109	1000

Precautions

■ SOLDERING INFORMATION

Reflow soldering

- Reflow soldering must be done within 48 hours after opening the aluminum envelope. The component must be stored under 30°C at 80% RH.
- The following soldering paste is recommended:
 - Melting temperature: 178~192°C
 - Composition: Sn 63%, Pb 37%
- Recommended thickness of metal mask is between 0.2 mm and 0.25 mm for screen printing.
- The following chart illustrates the maximum temperature limits for soldering:

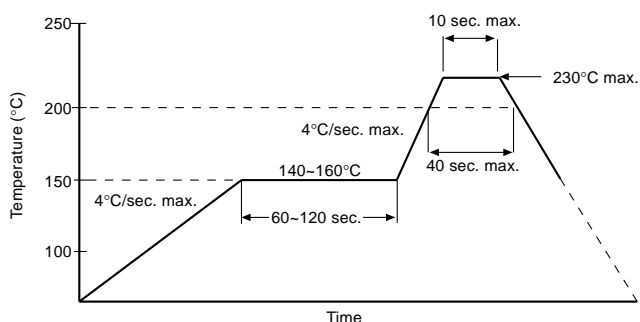

Manual soldering

- "Sn 60" (60% tin and 40% lead) or solder with silver content is recommended.
- Use a soldering iron of less than 25W. The temperature of the iron tip must be kept above 300°C (572°F).
- Solder each land for a maximum of 3 seconds.



OMRON ELECTRONICS LLC
 One East Commerce Drive
 Schaumburg, IL 60173
1-800-55-OMRON

OMRON CANADA, INC.
 885 Milner Avenue
 Scarborough, Ontario M1B 5V8
416-286-6465