

The Best Relaytion

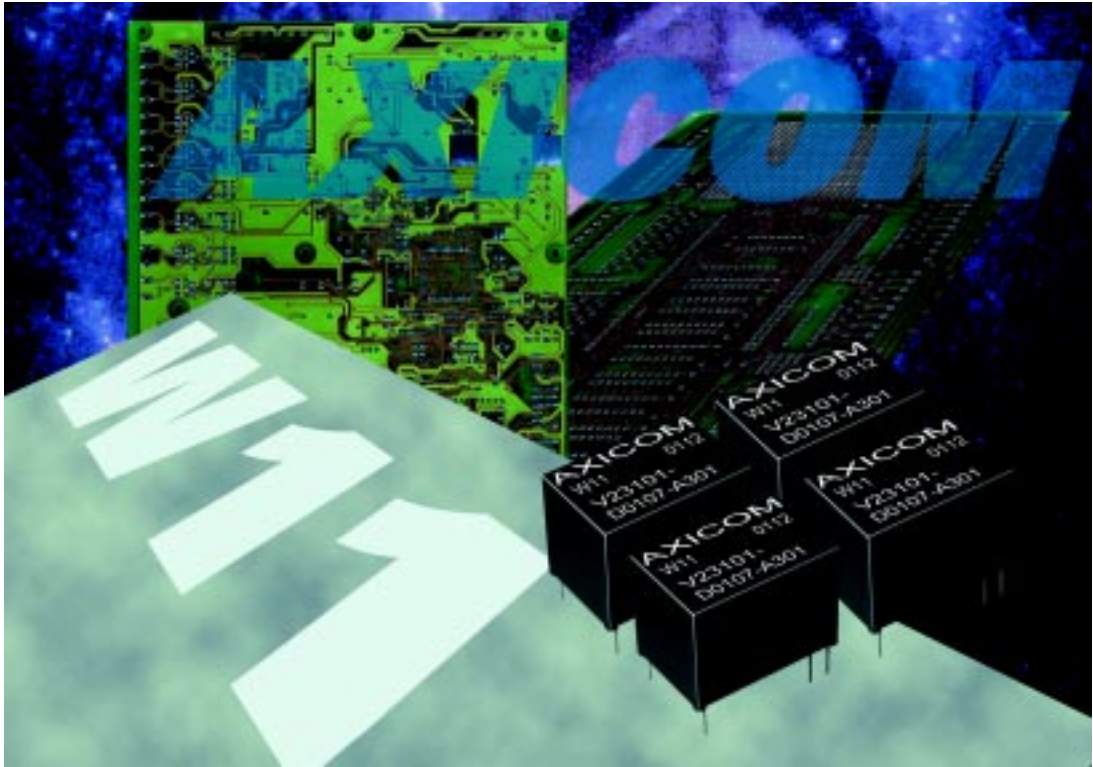

W11 Relay

1 pole PCB relay, non-polarized,
Through Hole Type (THT)

Relay types: Non-latching, 1 coil
 Terminal assignments symmetrical or asymmetrical
 5- or 6-pin version

Features

- Multi purpose relay
- Small size permitting high packing density
- 1 changeover contact (1 form C / SPDT)
- 200 mW and 450 mW coils
- 1 A and 3 A contacts
- High shock resistance of 30 g
- Ambient temperature for sensitive version up to 85°C
- Immersion cleanable

Typical applications

- Security devices
- Electric door openers
- Duplex intercommunication systems
- Measurement and controls

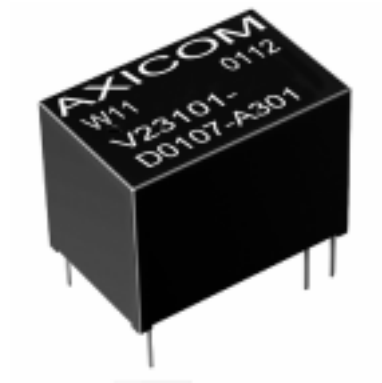

Dimension drawing (in mm)

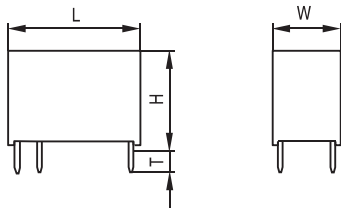

	V23101-Dxxx-Xxxx	
	mm	inch
L	15.5 ± 0.1	0.610 ± 0.004
W	10.5 ± 0.1	0.413 ± 0.004
H	11.5 - 0.2	0.453 - 0.008
T	3.5 - 0.2	0.138 - 0.008

Mounting hole layout

View on to the component side of the PCB

Version: 6 pins

Version: 5 pins (without pin no. 6)

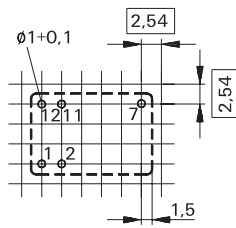
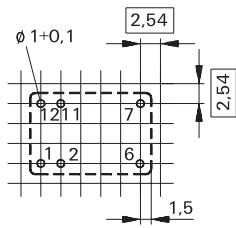

Terminal assignment

Relay - top view

6 pin version with symmetrical coil assignment
V23101-D0 xxx -A xxx

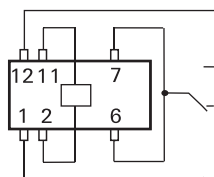

5 pin version with symmetrical coil assignment
V23101-D1 xxx -A xxx

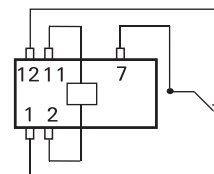

6 pin version with asymmetrical coil assignment
V23101-D0 xxx -B xxx

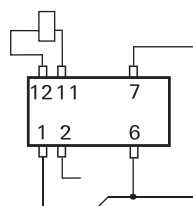

5 pin version with asymmetrical coil assignment
V23101-D1 xxx -B xxx

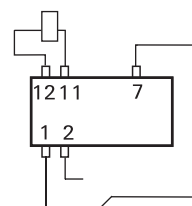

Coil Data (values at 23°C)

Nominal voltage U_{nom}	Operate/set voltage range		Release/reset voltage Minimum	Nominal power consumption	Resistance	Coil number
	Minimum voltage U_I	Maximum voltage U_{II}				
Vdc	Vdc	Vdc	Vdc	mW	$\Omega / \pm 10\%$	

450 mW nominal power consumption

1.5	1.3	2.6	0.15	375	6	001
3	2.1	4.7	0.30	450	20	002
5	3.5	7.9	0.50	446	56	003
6	4.2	9.5	0.60	450	80	004
9	6.3	14.2	0.90	450	180	005
12	8.4	19.0	1.20	450	320	006
24	16.8	38.0	2.40	450	1280	007

200 mW nominal power consumption

1.5	1.1	3.6	0.15	188	12	101
3	2.3	7.1	0.30	200	45	102
5	3.8	11.6	0.50	208	120	103
6	4.5	14.2	0.60	200	180	104
9	6.8	21.2	0.90	203	400	105
12	9.0	28.0	1.20	206	700	106
24	18.0	56.0	2.40	206	2800	107

U_I = Minimum voltage at 23° C after pre-energizing with nominal voltage without contact current

U_{II} = Maximum continuous voltage at 23°

The operating voltage limits U_I and U_{II} depend on the temperature according to the formula:

$$U_{I\ t_{amb}} = K_I \cdot U_{I\ 23^\circ\ C}$$

and

$$U_{II\ t_{amb}} = K_{II} \cdot U_{II\ 23^\circ\ C}$$

t_{amb} = Ambient temperature

$U_{I\ t_{amb}}$ = Minimum voltage at ambient temperature, t_{amb}

$U_{II\ t_{amb}}$ = Maximum voltage at ambient temperature, t_{amb}

K_I, K_{II} = Factors (dependent on temperature), see diagram

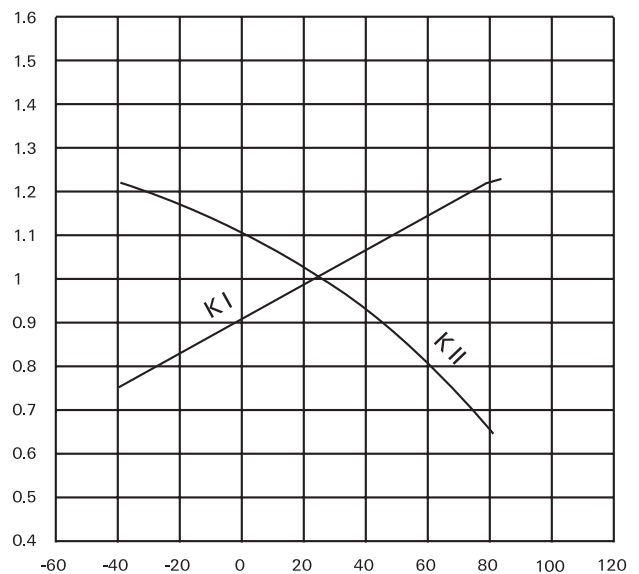

Ambient temperature t_{amb} [°C] →

Contact Data

Number of contacts and type	1 changeover contact	
Contact assembly	single contacts	
Contact material	AgPd, gold plated	AgNi
Limiting continuous current at max. ambient temperature	1 A	3 A
Maximum switching current	1.25	3 A
Maximum switching voltage	60 Vdc 125 Vac	60 Vdc 125 Vac
Maximum switching capacity	30 W / 60 VA	72 W / 360 VA
Thermoelectric potential	< 10 μ V	< 10 μ V
Initial contact resistance / measuring condition: 10 mA / 20 mV	100 m Ω	100 m Ω
Electrical endurance		
standard:		
at 24 Vdc / 1 A	3 x 10 ⁵	
at 24 Vdc / 2.5 A		2 x 10 ⁵
at 120 Vac / 0.5 A	1.5 x 10 ⁵	
at 120 Vac / 1 A		4 x 10 ⁵
sensitive:		
at 24 Vdc / 1 A	2 x 10 ⁵	
at 24 Vdc / 2.5 A		1 x 10 ⁵
at 120 Vac / 0.5 A	1 x 10 ⁵	
at 120 Vac / 1 A		3 x 10 ⁵
Mechanical endurance	typ. 10 ⁷ operations	

Insulation

Insulation resistance at 500 VDC	> 10 ⁹ Ω
Dielectric test voltage (1 min)	
between coil and contacts	1000 Vrms
between open contacts	750 Vrms

High Frequency Data

Capacitance	
between coil and contacts	max. 10 pF
between open contacts	max. 2 pF

General data

Operate time at U_{nom} typ. / max.	5 ms / 7 ms
Release time without diode in parallel, typ. / max.	3 ms / 5 ms
Release time with diode in parallel, typ. / max.	10 ms / 12 ms
Bounce time at closing contact, typ. / max.	1 ms / 2 ms NO contact 5 ms / 10 ms at NC contact
Maximum switching rate without load	20 operations/s
Ambient temperature	-40° C ... +70° C/85° C, standard / sensitive coil
Thermal resistance	< 125 K/W
Maximum permissible coil temperature	130° C
Vibration resistance (function)	10 g, 10 to 200 Hz
Shock resistance, half sinus, 11 ms	30 g (function) 100 g (damage)
Degree of protection	immersion cleanable, IP 67
Needle flame test	application time 20 s, burning time < 15 s
Mounting position	any
Processing information	Ultrasonic cleaning is not recommended
Weight (mass)	max. 4 g
Resistance to soldering heat	260° C / 10 s

All data refers to 23° C unless otherwise specified.

Packing

Dimensions in mm

Tube dimensions - 25 relays per tube, 625 relays per box

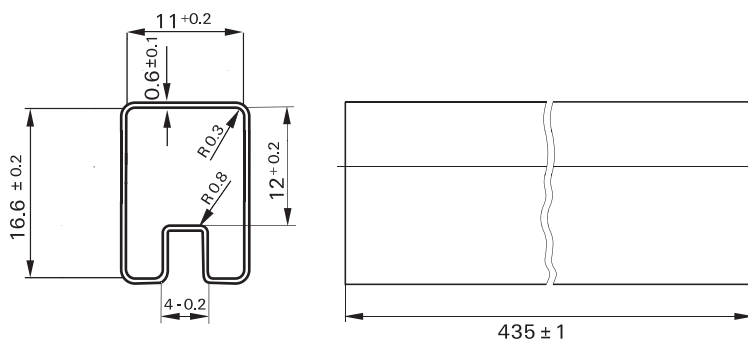

Ordering Information

Relay Code	Tyco Part Number	Relay Code	Tyco Part Number
V23101D0001A201	0-1393779-1	V23101D0103B201	2-1393779-7
V23101D0001B201	0-1393779-2	V23101D0104A201	2-1393779-8
V23101D0002A201	0-1393779-3	V23101D0104B201	2-1393779-9
V23101D0002B201	0-1393779-4	V23101D0105A201	3-1393779-0
V23101D0003A201	0-1393779-5	V23101D0105B201	3-1393779-1
V23101D0003B201	0-1393779-6	V23101D0106A201	3-1393779-2
V23101D0003B301	0-1393779-7	V23101D0106A301	0-1422037-2
V23101D0004A201	0-1393779-8	V23101D0106B201	3-1393779-3
V23101D0004B201	1-1393779-0	V23101D0106B301	3-1393779-4
V23101D0005A201	1-1393779-1	V23101D0107A201	3-1393779-5
V23101D0005B201	1-1393779-2	V23101D0107A301	3-1393779-7
V23101D0006A201	1-1393779-3	V23101D0107B201	3-1393779-8
V23101D0006A301	4-1419172-4	V23101D0108A201	3-1393779-9
V23101D0006B201	1-1393779-6	V23101D1003B201	4-1393779-0
V23101D0006B301	1-1393779-7	V23101D1006A201	4-1393779-1
V23101D0007A201	1-1393779-8	V23101D1006B201	4-1393779-2
V23101D0007B201	2-1393779-0	V23101D1007B201	0-1413012-1
V23101D0007B301	2-1393779-1	V23101D1106A201	4-1393779-3
V23101D0101A201	2-1393779-2	V23101D1106B201	4-1393779-4
V23101D0101B201	2-1393779-3	V23101D1106B301	4-1393779-5
V23101D0102A201	2-1393779-4	V23101D1107A201	4-1393779-6
V23101D0102B201	2-1393779-5	V23101D1107B201	4-1393779-7
V23101D0103A201	2-1393779-6		

Relay code:

V23101-Dwxxx-yzzz

w: 0 Standard 6 pins
1 5 pins version

xxx: See coil table on page 4

y: A Symmetrical coil assignment, see page 3
B Asymmetrical coil assignment, see page 3

zzz: 201 AgPd contacts
301 AgNi contacts

IM Relays

4th generation slim line – low profile polarized 2 c/o telecom relay with bifurcated contacts, available as non latching or latching relay with 1 coil. Nominal voltage range from 1.5... 24 V, coil power consumption of 140... 200 mW, latching relays with 1 coil 100 mW. The IM relay is available as through hole and surface mount type (J-Legs and Gull Wings) and capable to switch loads up to 60 W/62,5 VA. Dielectric strength fulfills the Bellcore requirements according GR 1089 (2,5 kV – 2 / 10 μ s) and FCC part 68 (1,5 kV – 10 / 160 μ s). The IM relay is CECC/IECQ approved and certified in accordance with IEC/EN 60950 and UL1950. Dimensions approx. 10 x 6 mm board space and 5,65 mm height.

P2 Relays

3rd generation polarized 2 c/o telecom relay with bifurcated contacts, available as non latching or latching relay with 1 or 2 coils. Nominal voltage range from 3 ... 24 V, coil power consumption 140 mW, latching relays with 1 coil 70 mW. The P2 relay is available as through hole or surface mount type and capable to switch currents up to 5 A. Dielectric strength fulfills the Bellcore requirements according GR 1089 (2,5 kV – 2 / 10 μ s) and FCC part 68 (1,5 kV – 10 / 160 μ s). Dimensions approx. 15 x 7,5 mm board space and 10 mm height.

FX Relays

3rd generation polarized 2 c/o telecom relay with bifurcated contacts, available as non latching or latching relay with 1 coil. Nominal voltage range from 3 ... 48 V, coil power consumption of 80 ... 260 mW for the high sensitive version, 140... 300 mW for the standard version, latching relays with 1 coil 100 mW. The FX2 relay is available as through hole type and capable to switch loads up to 60 W/62,5 VA. Dielectric strength fulfills the Bellcore requirements according GR 1089 (2,5 kV – 2 / 10 μ s) and FCC part 68 (1,5 kV – 10 / 160 μ s). The FX2 is CECC/IECQ approved and certified in accordance with IEC/EN 60950 and UL1950. Dimensions approx. 15 x 7,5 mm board space and 10,7 mm height.

FT2 / FU2 Relays

3rd generation non polarized, non latching 2 c/o telecom relay with bifurcated contacts. Nominal voltage range from 3 ... 48 V, coil power consumption 200 ... 300 mW. Most sensitive 48 V relay. Available as through hole and surface mount type. Dielectric strength fulfills the Bellcore requirements according GR 1089 (2,5 kV – 2 / 10 μ s) and FCC part 68 (1,5 kV – 10 / 160 μ s). The FT2/FU2 is CECC/IECQ approved and certified in accordance with IEC/EN 60950 and UL1950. Dimensions approx. 15 x 7,5 mm board space and 10 mm height.

FP2 Relays

3rd generation polarized 2 c/o telecom relay with bifurcated contacts, available as non latching or latching relay with 1 or 2 coils. Nominal voltage range from 3 ... 48 V, coil power consumption of 80 ... 260 mW for the high sensitive version, 140... 300 mW for the standard version, latching relays with 1 coil 100 mW.. The FP2 relay is available as through hole type and capable to switch loads up to 30 W/62,5 VA. Dielectric strength fulfills FCC part 68 (1,5 kV – 10 / 160 μ s). The FP2 is CECC/IECQ approved. Dimensions approx. 14 x 9 mm board space and 5 mm height.

MT2 / MT4

2nd generation non polarized, non latching 2 c/o and 4 c/o telecom and signal relay with bifurcated contacts. Nominal voltage range from 4.5 ... 48 V, coil power consumption 150/200/300/400 and 550 mW, and 300 mW (MT4). Dielectric strength fulfills the

requirements according FCC part 68 (1,5 kV – 10 / 160 μ s) for both and the Bellcore requirements according GR 1089 (2,5 kV – 2 / 10 μ s) the MT4 only.

Dimensions MT2 approx. 20 x 10 mm board space and 11 mm height, MT4 approx. 20 x 15 mm board space and 11 mm height.

D2n Relays

2nd generation non polarized 2 c/o relay for telecom and various other applications. Nominal voltage range from 3 ... 48 V, coil power consumption from 150 ... 500 mW. The D2n relay is capable to switch currents up to 3 A. Dielectric strength fulfills the requirements according FCC part 68 (1,5 kV – 10 / 160 μ s). Dimensions approx. 20 x 10 mm board space and 11,5 mm height.

P1 Relays

Extremely sensitive, polarized 1 c/o relay with bifurcated contacts for a wide range of applications, available as non latching or latching relay with 1 or 2 coils. Nominal voltage range from 3 ... 24 V, coil power consumption 65 mW, latching relays with 1 coil 30 mW. The P1 relay is available as through hole or surface mount type and capable to switch currents up to 1 A. Dielectric strength fulfills the requirements according FCC part 68 (1,5 kV – 10 / 160 μ s). Dimensions approx. 13 x 7,6 mm board space and 7 mm height for THT or 8 mm height for SMT version.

W11 Relays

Low cost, non polarized 1 c/o relay for various applications. Nominal voltage range from 3 ... 24 V, coil power consumption 450 mW, sensitive versions 200 mW. The W11 relay is capable to switch currents up to 3 A. Dielectric strength 1000 Vrms. Dimensions approx. 15,6 x 10,6 mm board space and 11,5 mm height.

Reed Relays

High sensitive, non polarized relay for telecom and various other applications, available with 1 n/o, 2 n/o or 1c/o contacts. Nominal voltage range from 5 ... 24 V, coil power consumption 50...280 mW for 1 n/o and 125 ... 280 mW for 2 n/o or 1 c/o versions. Reedrelays are available in DIP or SIL housing and capable to switch currents up to 0,5 A. Integrated diode and/or electrostatic shield optional. Dielectric strength 1500 Vdc. Dimensions approx. 19,3 x 7 mm board space and 5 ... 7,5 mm height for DIP or 19,8 x 5 mm board space and 7,8 mm height for SIL version.

Cradle Relays

Extremely reliable and mature relay family of 1st generation for various signal switching applications. Available as non polarized, polarized / latching and relay with AC coil. The benefit is the possibility of combining various contact sets from 1 up to 6 poles, single and bifurcated contacts, different contact materials with a coil voltage range from 1,5 Vdc to 220 Vac. Cradle relays are available as dust protected and hermetically sealed versions, with plug in or solder terminals and are capable to switch currents up to 5 A. Forcibly guided (linked) contact sets optional. Dielectric strength 500 Vrms. Dimensions from approx. 19 x 24 to 19x35 mm board space and 30 mm height.

Other Relays

We offer a variety of different relay families for maintenance and replacement purposes. These relays are up to 60 years old now, such as Card Relay SN (V23030 / V23031 series), Small General Purpose Relay (V23006 series), Small Polarized Relay (V23063 ... V23067 and V23163 ... V23167 series). Accessories like sockets, hold down springs, etc. optional.



Tyco Electronics AXICOM Ltd.
Seestrasse 295 - P.O. Box 220
CH-8804 Au-Wädenswil / Switzerland
Phone +41 1 782 9111
Fax +41 1 782 9080
E-mail: axicom@tycoelectronics.com



Tyco Electronics AMP GmbH
Paulsternstrasse 26
D-13629 Berlin / Germany
Phone +49 30 386 38260
Fax +49 30 386 38569
E-mail: axicom@tycoelectronics.com



Tyco Electronics EC Trutnov s.r.o.
Komenského 821
CZ-541 01 Trutnov / Czech Republic
E-mail: axicom@tycoelectronics.com

Tyco Electronics Corporation
POB 3608,
Harrisburg, PA 17105, USA
Phone +001 800-522-6752